



LINGO REGALSYSTEM

01.01.2024



LINGO SHELVING

Das Regalsystem Lingo bietet Ihnen aufgrund seiner Funktionalität und Flexibilität eine außergewöhnliche Vielseitigkeit.

Es verkörpert die wahre Bedeutung von Flexibilität. Durch seine modulare Konstruktion bietet es den höchsten Grad an Funktionalität und Vielfalt. Sein Stil und seine Qualität lassen es sowohl für moderne als auch für klassische Bibliotheken geeignet erscheinen.

Das Regalsystem Lingo bietet Ihnen unendliche Möglichkeiten in Funktion und Design. Die Bauweise des Regalsystems, mit seinen Lochungen im Raster von 25 mm, erlaubt eine einfache Montage und Verstellbarkeit der Fachböden, ohne Spezialwerkzeuge.

Das Regalsystem Lingo ist einseitig und doppelseitig lieferbar, mit oder ohne Rollen und ist mit entweder Rahmentraverse, Rückwand aus Holz oder Diagonaltraverse gebaut. Es kann mit Fachböden aus Metall oder Holzwerkstoff, sowie mit einer großen Auswahl an Zubehörkomponenten, ausgestattet werden. Das Ergebnis – ein maßgeschneidertes Regalsystem, das die Anforderungen speziell Ihrer Bibliothek erfüllt.





INDEX

FSC®	4
DESIGNAUSWAHL	6
TECHNISCHE SPEZIFIKATIONEN	10
DIMENSIONEN	20
SEKTIONSBAUWEISE	24
GERADE UND RUNDE KOMBINATIONEN	28

KONFIGURATIONEN

BBN001

MIT VERSTELLBAREN FÜSSEN, FÜR ABDECKFACHBODEN

Einseitige Regale mit Rahmentraverse.....	30
Doppelseitige Regale mit Rahmentraverse.....	32
Einseitige Regale mit hoch Rückwand.....	38
Doppelseitige Regale mit hoch Rückwand.....	40
Einseitige Regale mit niedrig Rückwand.....	44
Doppelseitige Regale mit Rahmentraverse.....	46
Einseitige Regale mit Diagonaltraverse.....	50
Doppelseitige Regale mit Diagonaltraverse.....	52

BBN002

MIT VERSTELLBAREN FÜSSEN UND ABDECKPLATTE

Einseitige Regale mit Rahmentraverse.....	56
Doppelseitige Regale mit Rahmentraverse.....	62
Einseitige Regale mit Rückwand.....	70
Doppelseitige Regale mit Rückwand.....	76
Einseitige Regale mit Diagonaltraverse.....	84
Doppelseitige Regale mit Diagonaltraverse.....	90

BBN011

MIT ROLLENPLATTE, FÜR ABDECKFACHBODEN

Doppelseitige Regale mit Rahmentraverse.....	98
Doppelseitige Regale mit hoch Rückwand.....	104
Doppelseitige Regale mit niedrig Rückwand.....	110
Doppelseitige Regale mit Diagonaltraverse.....	116

BBN012

MIT ROLLENPLATTE UND ABDECKPLATTE

Doppelseitige Regale mit Rahmentraverse.....	122
Doppelseitige Regale mit Rahmentraverse.....	128
Doppelseitige Regale mit Diagonaltraverse.....	134

LINGO SQUARE

Mit Sockel.....	138
Mit Rollen.....	140

KOMPONENTEN

CHECKLISTE	143
-------------------------	-----

FACHBÖDEN

S1, S2, S3, S4 - Metallfachböden.....	144
ST1, ST2, ST3 - Metallabdeckböden.....	156
W1, W2, W3, W4 - Holzfachböden.....	166
WT1 - Holzabdeckböden.....	174
WO1 - Holzabdeckplatten.....	179
Präsentation und Aufbewahrung.....	186

ZUBEHÖR

Tröge aus Metall.....	188
Tröge aus Holz.....	194
Präsentation und Aufbewahrung.....	195
Buchstützen.....	200
Beschriftungsschilder für Fachböden.....	202
Beschriftungsschilder für Regalseiten.....	204

ROLLEN UND SOCKELBLENDE

Sichtbare Rollen.....	207
Verdeckte Rollen.....	207
Sockelblende.....	208
Rollenplatte.....	208

SEITENVERKLEIDUNGEN

Mit Stellfüßen/für Rollenset:

Einseitige Seitenverkleidungen - für Abdeckfachboden.....	210
Doppelseitige Seitenverkleidungen - für Abdeckfachboden.....	212
Doppelseitige Lamellenwand - für Abdeckfachboden.....	213
Einseitige Seitenverkleidungen - für Holzabdeckplatte.....	214
Doppelseitige Seitenverkleidungen - für Holzabdeckplatte.....	216
Doppelseitige Lamellenwand - für Holzabdeckplatte.....	217

Für Rollenplatte:

Doppelseitige Seitenverkleidungen - für Abdeckfachboden.....	218
Doppelseitige Lamellenwand - für Abdeckfachboden.....	219
Doppelseitige Seitenverkleidungen - für Holzabdeckplatte.....	220
Doppelseitige Lamellenwand - für Holzabdeckplatte.....	221

Funktionsseite:

Holzfunktionsseite.....	222
Zubehör für Holzfunktionsseite.....	223

VERBINDUNGSELEMENT

Rückwand aus Holz.....	224
Rahmentraverse.....	226
Diagonaltraverse.....	227

BELEUCHTUNG

Book Big Beleuchtung.....	228
---------------------------	-----

KONFIGURATIONEN

BBN201

26° MIT VERSTELLBAREN FÜSSEN, FÜR ABDECKFACHBODEN

26° - Rahmentraverse	232
26° - Hoch Metallrückwand	236
26° - Niedrige Metallrückwand	240

BBN202

26° MIT VERSTELLBAREN FÜSSEN UND ABDECKPLATTE

26° - Rahmentraverse - Freistehende Sektion	244
26° - Rahmentraverse - Links Anfangssection	245
26° - Rahmentraverse - Rechts Anfangssection	246
26° - Rahmentraverse - Mittelsektion	247
26° - Rahmentraverse - Links Endsektion	248
26° - Rahmentraverse - Rechts Endsektion	249

26° - Metallrückwand - Freistehende Sektion	252
26° - Metallrückwand - Links Anfangssection	253
26° - Metallrückwand - Rechts Anfangssection	254
26° - Metallrückwand - Mittelsektion	255
26° - Metallrückwand - Links Endsektion	256
26° - Metallrückwand - Rechts Endsektion	257

BBN211

26° MIT ROLLENPLATTE, FÜR ABDECKFACHBODEN

26° - Rahmentraverse - Freistehende Sektion	260
26° - Hoch Metallrückwand - Freistehende Sektion	264
26° - Niedrige Metallrückwand - Freistehende Sektion	268

BBN212

26° MIT ROLLENPLATTE UND ABDECKPLATTE

26° - Rahmentraverse - Freistehende Sektion	272
26° - Metallrückwand - Freistehende Sektion	276

BBN221 - 18° MIT VERSTELLBAREN FÜSSEN, FÜR ABDECKFACHBODEN

18° - Rahmentraverse	280
18° - Hoch Metallrückwand	284
18° - Niedrige Metallrückwand	290

BBN222 - 18° MIT VERSTELLBAREN FÜSSEN UND ABDECKPLATTE

18° - Rahmentraverse - Freistehende Sektion	292
18° - Rahmentraverse - Links Anfangssection	293
18° - Rahmentraverse - Rechts Anfangssection	294
18° - Rahmentraverse - Mittelsektion	295
18° - Rahmentraverse - Links Endsektion	296
18° - Rahmentraverse - Rechts Endsektion	297

18° - Metallrückwand - Freistehende Sektion	300
18° - Metallrückwand - Links Anfangssection	301
18° - Metallrückwand - Rechts Anfangssection	302
18° - Metallrückwand - Mittelsektion	303
18° - Metallrückwand - Links Endsektion	304
18° - Metallrückwand - Rechts Endsektion	305

BBN231 - 18° MIT ROLLENPLATTE, FÜR ABDECKFACHBODEN

18° - Rahmentraverse - Freistehende Sektion	308
18° - Hoch Metallrückwand - Freistehende Sektion	312
18° - Niedrige Metallrückwand - Freistehende Sektion	316

BBN232 - 18° MIT ROLLENPLATTE UND ABDECKPLATTE

18° - Rahmentraverse - Freistehende Sektion	320
18° - Metallrückwand - Freistehende Sektion	324

KOMPONENTEN

CHECK LIST	327
-------------------------	-----

FACHBÖDEN

S5, S6 - Metallfachböden	328
W5, W6, W7, W8 - Holzfachböden	334
WT5, WT7 - Holzabdeckböden	340
WO5 - Holzabdeckplatten	344

ROLLEN UND SOCKELBLENDE

Sichtbare Rollen	347
Verdeckte Rollen	347
Rollenplatte	348
Sockelblende	349

SEITENVERKLEIDUNGEN

Mit Stellfüßen/für Rollenset:

Doppelseitige Seitenverkleidungen - für Abdeckfachboden	350
Doppelseitige Seitenverkleidungen - für Holzabdeckplatte	352

Für Rollenplatte:

Doppelseitige Seitenverkleidungen - für Abdeckfachboden	354
Doppelseitige Seitenverkleidungen - für Holzabdeckplatte	360

Funktionsseite:

Holzfunksionsseite	358
Zubehör für Holzfunksionsseite	359

VERBINDUNGSELEMENT

Metallrückwand	360
Rahmentraverse	362

HOLZ AUS NACHHALTIGER FORSTWIRTSCHAFT



Wir verpflichten uns dazu, den Anteil von Holz aus nachhaltiger Forstwirtschaft in unseren Produkten zu steigern und so die nachhaltige Forstwirtschaft zu unterstützen – für eine bessere Welt.

Regierungen und lokale Behörden spezifizieren das Angebot an legal und verantwortungsvoll bezogenem Holz in ihren Beschaffungsrichtlinien.

Wir haben in ein vom FSC ausgestelltes Produktkettenzertifikat für mehrere Standorte investiert (FSC-C144988). Dieses Zertifikat dokumentiert, dass wir Holz aus nachhaltiger Forstwirtschaft anbieten können. Der FSC® (Forest Stewardship Council) ist ein internationales Zertifizierungssystem. Es dokumentiert, dass FSC-gekennzeichnete Produkte aus nachhaltiger Forstwirtschaft stammen.

Dank der Zusammenarbeit mit zertifizierten Lieferanten können wir alle lackierte und furnierte Teile aus nachhaltiger Forstwirtschaft anbieten (in diesem Dokument oben auf jeder Seite vermerkt, die Holzkomponenten zeigt).

Was ist nachhaltige Forstwirtschaft?

Gemäß dem FSC herrschen in den Wäldern, die entsprechend den Richtlinien und Kriterien des FSC bewirtschaftet werden, faire Bedingungen für die Arbeiter. Die indigenen Gemeinschaften und die lokale Bevölkerung werden respektiert und strenge Umweltschutzmaßnahmen werden durchgeführt.

Die FSC-Kennzeichnung garantiert, dass die Bäume, von denen das Holz stammt, ersetzt werden oder die Möglichkeit haben, sich auf natürliche Weise zu regenerieren.

Die FSC-Kennzeichnung garantiert auch dass das gesamte Holz ist rückverfolgbar – vom Wald bis ins Geschäft. Jedes Glied der Kette zwischen dem Wald und dem Verbraucher wird zertifiziert. So kann eindeutig identifiziert werden, welches Holz aus nachhaltiger Forstwirtschaft stammt und welches nicht.

Quelle: Forest Stewardship Council - <http://www.fsc-uk.org/en-uk>

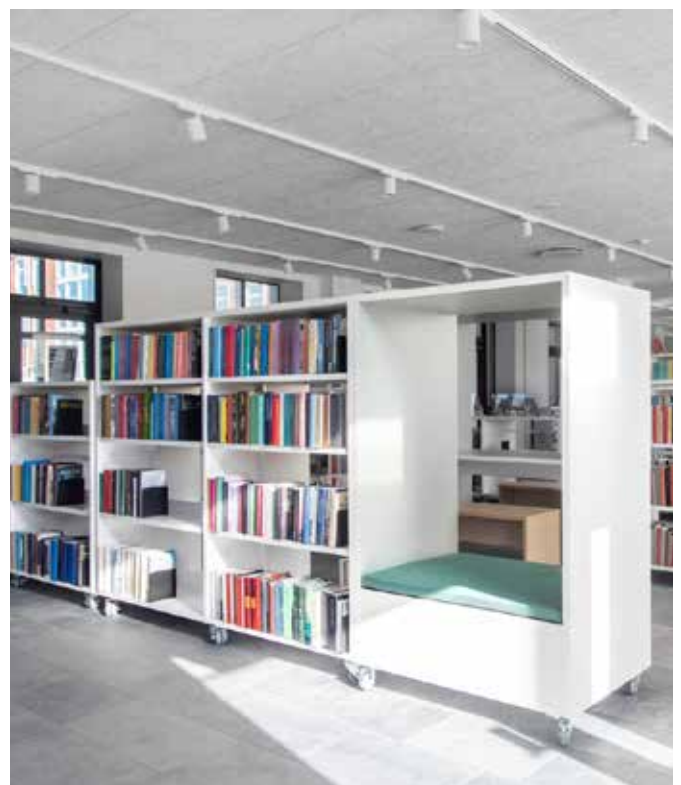

DESIGNAUSWAHL

TEILE AUS METALL - LACKIERT

A PREISGRUPPE OHNE PREISAUFSCHLAG (Metall glatte Oberfläche)



A03 Verkehrsweiß
RAL 9016
Glanz 75-90



A02 Perlweiß
RAL 1013
Glanz 40-50

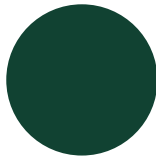

A22 Moosgrün
RAL 6005
Glanz 71-85



A26 Tannengrün
RAL 6009
Glanz 71-85

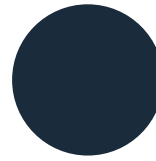

A12 Stahlblau
RAL 5011
Glanz 71-85

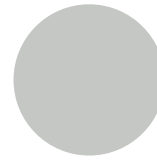

A13 Lichtgrau
RAL 7035
Glanz 71-85

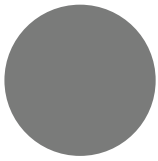

A15 Staubgrau
RAL 7037
Glanz 71-85

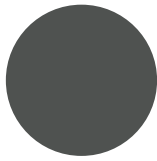

A16 Verkehrsgrau
RAL 7043
Glanz 71-85

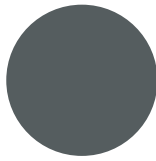

A17 Basaltgrau
RAL 7012
Glanz 71-85

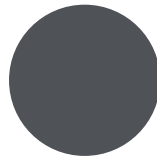

A18 Schiefergrau
RAL 7015
Glanz 71-85

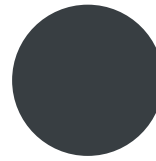

A19 Anthrazitgrau
RAL 7016
Glanz 71-85

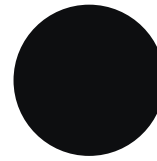

A25 Tiefschwarz
RAL 9005
Glanz 71-85

B PREISGRUPPE MIT AUFSCHLAG VON 7% (Metall glatte Oberfläche)



A01 Reinweiß
RAL 9010
Glanz 71-85

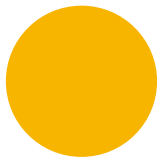

A04 Verkehrsgelb
RAL 1023
Glanz 71-85

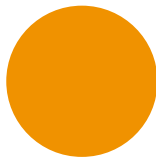

A05 Sonengelb
RAL 1037
Glanz 71-85

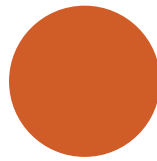

A06 Signalorange
RAL 2010
Glanz 71-85

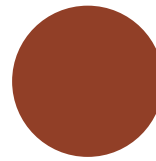

A07 Perlorange
RAL 2013
Glanz 65-85

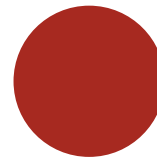

A08 Feuerrot
RAL 3000
Glanz 71-85

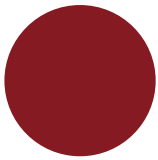

A09 Rubinrot
RAL 3003
Glanz 71-85



A21 Resedagrün
RAL 6011
Glanz 71-85

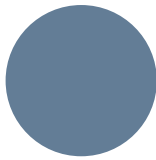

A10 Taubenblau
RAL 5014
Glanz 71-85

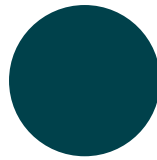

A11 Ozeanblau
RAL 5020
Glanz 71-85

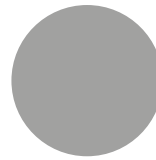

A14 Weißaluminium
RAL 9006
Glanz 50-70

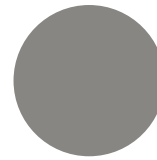

A31 Graualuminium
RAL 9007
Glanz 50-70

B PREISGRUPPE MIT AUFSCHLAG VON 7% (Metall Struktur Oberfläche)



A27 Reinweiß
RAL 9010

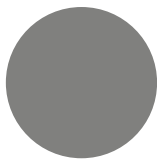

A29 Concertinagrau

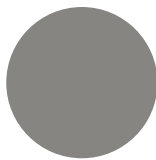

A28 Graualuminium
RAL 9007

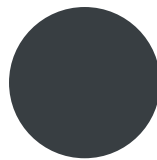

A23 Anthrazitgrau
RAL 7016

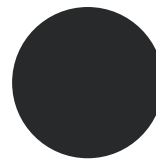

A24 Graphitschwarz
RAL 9011

Beachten:

- Andere RAL oder NCS-Farben werden mit einer Gebühr ab EUR 250 netto und einem Preisaufschlag von 15% geliefert. Es ist mit einem Aufschlag für Metallic-Effekte oder verschiedene Oberflächenstrukturen zu rechnen.
- Siehe spezifische Farbe für die Stahlglanzspezifikation. Spezielle Anforderungen außerhalb dieser Skala sind von den oben genannten Aufschlägen nicht gedeckt.
- Verchromte, elektro-galvanisierte und Aluminium-Teile sind nicht in anderen Farben erhältlich.
- Produkte wie z. B. Rollen und Teleskopschienen können nicht in anderen als den in der Preisliste genannten geliefert werden.

DESIGNAUSWAHL

TEILE AUS HOLZ - MELAMIN/HOCHDRUCKLAMINAT

A PREISGRUPPE OHNE PREISAUFSCHLAG

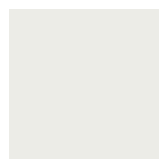

D61/L61
Signalweiß
RAL 9003



D72/L72
Perlweiß
Ähnlich RAL 1013

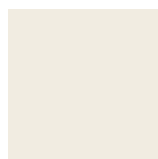

D62/L62
Reinweiß
Ähnlich RAL 9010



D63/L63
Stahlblau
RAL 5011



D71/L71
Staubgrau
Ähnlich RAL 7037



D16/L16
Basaltgrau
Ähnlich RAL 7012



D19/L19
Schiefergrau
Ähnlich RAL 7015 und
RAL 7016



D04/L04
Buche Dekor



D05/L05
Ahorn Dekor



D06/L06
Kirsche Dekor



D07/L07
Eiche Dekor



D08/L08
Olive Dekor

C PREISGRUPPE MIT AUFSCHLAG VON 10%



D64/L64
Signalgelb
RAL 1003



D65/L65
Gelborange
RAL 2000



D66/L66
Reinorange
RAL 2004



D67
Verkehrsrot
RAL 3020



E02/L02
Rubinrot
Ähnlich RAL 3003



D13/L13
Limonegrün
Ähnlich NCS S1060-G40Y



D68/L68
Resedagrün
Ähnlich RAL 6011



D14/L14
Kristallblau
Ähnlich NCS S1020-R90B



D73/L73
Taubenblau
RAL 5014



D74/L74
Ozeanblau
Ähnlich RAL 5020



D69/L69
Lichtgrau
Ähnlich RAL 7035



D70/L70
Weißaluminium
Ähnlich RAL 9006



D75/L75
Tiefschwarz
Ähnlich RAL 9005

Beachten:

- Die obige Farbauswahl wird sowohl in Melamin (D/Exx) als auch in Hochdrucklaminat (Lxx) gezeigt.
- W3/W4 Fachböden in L1000 mm werden in Laminat geliefert.

DESIGNAUSWAHL

TEILE AUS HOLZ - LACKIERT

A PREISGRUPPE OHNE PREISAUFCHLAG

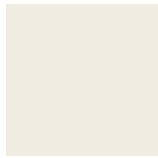

**A01
Reinweiß**
RAL 9010
Glanz 20-30



**A02
Perlweiß**
RAL 1013
Glanz 20-30

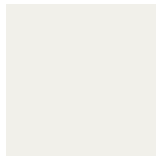

**A03
Verkehrsweiß**
RAL 9016
Glanz 20-30



**A04
Verkehrsgelb**
RAL 1023
Glanz 20-30



**A05
Sonnengelb**
RAL 1037
Glanz 20-30



**A06
Signalorange**
RAL 2010
Glanz 20-30



**A07
Perlorange**
RAL 2013
Glanz 20-30



**A08
Feurrot**
RAL 3000
Glanz 20-30



**A09
Rubinrot**
RAL 3003
Glanz 20-30



**A21
Resedagrün**
RAL 6011
Glanz 20-30

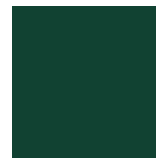

**A22
Moosgrün**
RAL 6005
Glanz 20-30



**A26
Tannengrün**
RAL 6009
Glanz 20-30



**A10
Taubenblau**
RAL 5014
Glanz 20-30



**A11
Ozeanblau**
RAL 5020
Glanz 20-30



**A12
Stahlblau**
RAL 5011
Glanz 20-30



**A13
Lichtgrau**
RAL 7035
Glanz 20-30



**A14
Weißaluminium**
RAL 9006
Glanz 20-30



**A31
Graualuminium**
RAL 9007
Glanz 20-30



**A15
Staubgrau**
RAL 7037
Glanz 20-30



**A16
Verkehrsgrau**
RAL 7043
Glanz 20-30



**A17
Basaltgrau**
RAL 7012
Glanz 20-30



**A18
Schiefergrau**
RAL 7015
Glanz 20-30



**A19
Anthrazitgrau**
RAL 7016
Glanz 20-30



**A25
Tiefschwarz**
RAL 9005
Glanz 20-30

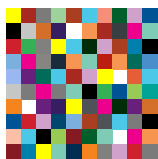

**A
Alle RAL/NCS Farben**
Glanz 20-30

Beachten:

- Die obige Farbauswahl entspricht unseren Stahlfarben. Beachten Sie, dass Sie jede RAL/NCS-Farbe ohne Aufschlag bestellen können.
- Farben mit Metallic-Effekt oder unterschiedlichen Strukturen werden mit einem Preisaufschlag geliefert, fragen Sie bitte unsere Verkaufsabteilung.

DESIGNAUSWAHL

TEILE AUS HOLZ - FURNIER

A PREISGRUPPE OHNE PREISAUFCHLAG



55
Leicht gedämpfte
Buche



66
Eiche



67
Ahorn



68
Eshe



69
Birke

Beachten:

- Die Holzfurniere können auch gefärbt werden mit einem zusätzlichen Aufschlag von 25%, fragen Sie bitte unsere Verkaufsabteilung. Muster werden zur Genehmigung vorgelegt.

TECHNISCHE SPEZIFIKATIONEN

ALLGEMEINE SPEZIFIKATIONEN

MAßE

Die Maße der kompletten Sektionen in den erhältlichen Achsmaßen und Höhen befinden sich in jeder Abteilung der Preisliste, die komplette Konfigurationen enthält. Siehe Inhaltsverzeichnis als Überblick. Die Maße der einzelnen Teile finden Sie unter „Komponenten“. Alle Maße sind nominal.

HÖCHSTBELASTUNG

Die Regalsektionen dürfen nur auf geradem, ebenem Fußboden montiert werden. Stellen Sie vor dem Laden der Regale sicher, dass der Boden für das Gewicht des Regals und des Lagerguts geeignet ist.

Die Höchstbelastungswerte unten dürfen nicht überschritten werden.

Maximale Drucklast für Lingo einseitige Sektion: 480 kg

Maximale Drucklast für Lingo doppelseitige Sektion: 960 kg

Maximale Drucklast für Lingo doppelseitige Sektion auf Rollenrahmen mit sichtbaren/verdeckten Rollen: 400 kg

Maximale Drucklast für Lingo doppelseitige Sektion auf Rollenplatte: 200 kg

Maximale Drucklast für Lingo Square: 600 kg

S1 - Metallfachboden mit H47 mm Metallbuchanschlag: 80 kg

S2 - Metallfachboden mit H17 mm Acrylbuchanschlag: 80 kg

S3 - Metallfachboden mit H25 mm Metallbuchanschlag: 80 kg

S4 - Metallfachboden: 80 kg

S5 - Innerer runder Metallfachboden mit H47 mm Metallbuchanschlag: 80 kg

S5 - Äußerer runder Metallfachboden mit H47 mm Metallbuchanschlag: 80 kg

S6 - Innerer runder Metallfachboden: 80 kg

S6 - Äußerer runder Metallfachboden: 80 kg

ST1 - Metallabdeckboden: 25 kg

ST2 - Metallabdeckboden: 80 kg

ST3 - Metallabdeckboden: 80 kg

S4 - Metallfachboden: 80 kg

ST5 - Innerer einseitiger runder Abdeckboden aus Metall H25/47 mm Vorderkante: 25 kg

ST5 - Äußerer einseitiger runder Abdeckboden aus Metall H25/47 mm Vorderkante: 25 kg

W1 - Holzfachboden mit H47mm Metallbuchanschlag: 80 kg

W2 - Holzfachboden: 80 kg

W3 - Holzfachboden mit H47 mm Metallbuchanschlag: 60 kg

W4 - Holzfachboden: 60 kg

W5 - Innerer runder Holzfachboden mit H47 mm Metallbuchanschlag: 80 kg

W5 - Äußerer runder Holzfachboden mit H47 mm Metallbuchanschlag: 80 kg

W6 - Innerer runder Holzfachboden: 80 kg

W6 - Äußerer runder Holzfachboden: 80 kg

W7 - Innerer runder Holzfachboden mit H47 mm Metallbuchanschlag: 60 kg

W7 - Äußerer runder Holzfachboden mit H47 mm Metallbuchanschlag: 60 kg

W8 - Innerer runder Holzfachboden: 60 kg

W8 - Äußerer runder Holzfachboden: 60 kg

WT1 - Holzabdeckboden: 25 kg

WT3 - Holzabdeckplatte: 25 kg

WT5 - Innerer runder Abdeckboden aus Holz: 25 kg

WT5 - Äußerer runder Abdeckboden aus Holz: 25 kg

WT7 - Innerer runder Abdeckboden aus Holz: 25 kg

WT7 - Äußerer runder Abdeckboden aus Holz: 25 kg

WO1 - Obenliegende Abdeckplatte aus Holz: 25 kg

WO5 - Runde obenliegende Abdeckplatte aus Holz: 25 kg

Trog mit Auszug: 40 kg.

TECHNISCHE SPEZIFIKATIONEN

ALLGEMEINE SPEZIFIKATIONEN

SEKTIONEN MIT STELFÜßEN UND ABDECKBÖDEN

Diese sind als freistehende und mittlere Sektionen lieferbar.

SEKTIONEN MIT STELFÜßEN UND OBENLIEGENDEN ABDECKPLATTEN

Diese sind als Anfang-, Mittel- und Endsektionen lieferbar. Sie können 18°/26° runde mit geraden Sektionen kombinieren, um die erwünschte Konfiguration zu schaffen. Die maximale Anzahl der kombinierten geraden und runden Regalsektionen, die in einem durchgehenden Regal aufgebaut werden können, ist auf Seite 28-29 angegeben. Die Stellfüße können auch bei beladenen Fachböden verstellt werden.

SEKTIONEN MIT ROLLEN

Nur doppelseitige Regaleinheiten mit einer max. Höhe von 152 cm und max. 3 Sektionen aneinander können auf Rollen montiert werden. Regale auf Rollen dürfen nicht für Transportzwecke verwendet werden. Die Rollen sind nur dazu da, um das Regal zu bewegen, siehe Anleitung unten. Das Überqueren von Türschwellen kann gefährlich sein. Nach dem Verschieben des Regals müssen Sie die Bremsen feststellen. Regale müssen im Prinzip auf einem ebenen, waagerechten Boden bewegt und aufgestellt werden.

Es besteht eine Verletzungsgefahr, wenn das Regalsystem nicht korrekt bewegt wird. Deshalb müssen die folgenden Verhaltensregeln beachtet werden:

- Es muss sichergestellt werden, dass während der Bewegung keine Gegenstände aus den Regalen fallen können. Im Zweifelsfall sollten Sie die Gegenstände vor dem Umzug entfernen.
- Verwenden Sie maximal zwei Personen, um das Regalsystem zu bewegen.
- Achten Sie darauf, das Regalsystem in einer gleichmäßigen Bewegung zu versetzen, vermeiden Sie ruckartige Bewegungen.
- Bewegen Sie das Regalsystem nur an den Stirnseiten, stehen Sie während der Bewegung nicht an den Längsseiten des Regalsystems.
- Um Verletzungen zu vermeiden, müssen Sie darauf achten, dass Sie immer genügend Abstand zu den umliegenden Wänden und anderen Einrichtungsgegenständen haben.
- Wenn mehr als eine Person beteiligt ist, sollten Sie die Richtung und die Absicht koordinieren, bevor Sie das Regalsystem tatsächlich bewegen.
- Achten Sie darauf, dass Sie das Regalsystem nur auf einem flachen, ebenen Boden ohne Neigung bewegen. Der Boden muss frei von jeglichen Gegenständen sein. Auch Kleinteile können eine Rolle plötzlich blockieren. In diesem Fall könnte das Regalsystem kippen oder den Boden beschädigen.
- Lösen Sie vor der Bewegung die Rollenfeststeller.
- Blockieren Sie nach der Bewegung die Rollenfeststeller.

GEWICHT BEI REGALEN MIT ROLLEN

Sichtbare Rollen auf Rollenplatte gibt es mit und ohne Feststeller. Wir empfehlen, mindestens zwei Rollen mit Feststellern für eine oder mehrere nebeneinander liegende Sektionen zu montieren. Maximale Belastung 100 kg pro sichtbare Rolle/400 kg pro Sektion.

Die verdeckten Rollen auf der Rollenplatte werden ohne Feststeller geliefert, so dass Sie beim Aufstellen des Regals nur die Stellfüße einstellen müssen. Maximale Belastung von 100 kg pro verdeckte Rolle/400 kg pro Sektion.

Die Sektionen mit Rollenplatten sind mit 4, 6 oder 8 Rollen ausgestattet, davon 2 mit Feststellern. Maximale Belastung von 200 kg pro Sektion.

REGALE MIT FACHBÖDEN

Sektionen mit Rückwand/Rahmentraverse: Jede Sektion muss mit mindestens 2 Fachböden (4 Fachböden bei doppelseitigen Sektionen) – oberstem und unterstem – ausgestattet werden, die mit Schrauben in die Seitenwände befestigt werden. Übrige Fachböden können ohne Schrauben montiert werden.

Sektionen mit Diagonaltraverse: Jede Sektion mit einer Höhe von mehr als 1220 mm muss mit mindestens 3 Fachböden (6 Fachböden bei doppelseitigen Sektionen) – oberstem, mittlerem und unterstem – ausgestattet werden, die zwecks Stabilität in die Seitenwände mit Schrauben befestigt werden.

TECHNISCHE SPEZIFIKATIONEN

ALLGEMEINE SPEZIFIKATIONEN

STABILITÄT

Seitenwände sind mit Stellfüßen ausgestattet, mit Ausnahme von Seitenwänden für Rollenplatten. Einseitige Seitenwände werden mit Wandbefestigung geliefert.

ABGERUNDETE ECKEN

Sämtliche Regaleinheiten und Konsole haben abgerundete Ecken.

DICHTE

Spanplatte hat eine Dichte von 600-700 kg/m³

Tischlerplatte hat eine Dichte von 602 kg/m³ (+/- 2 %)

MDF (Faserplatte mittlerer Dichte) hat eine Dichte von 700 kg/m³ (+/- 5-7 %)

TRÖGE

Die Regale können mit Trögen ausgestattet werden. Das Herausziehen eines Troges, ebenso wie mehrerer Tröge, kann zum Kippen des Regals führen. Stellen Sie sicher, dass das Regal nicht kippen kann, indem Sie das Regal sichern. Im Zweifelsfall müssen Sie das Regal am Boden, an der Wand oder an der Decke befestigen.

Aus Sicherheitsgründen:

- Es ist nicht erlaubt, Tröge mit mehr als 45 kg zu beladen.
- Verwenden Sie die Tröge nicht als Stufe. Der unterste Trog muss mindestens 50 cm über dem Boden montiert werden. Damit soll sichergestellt werden, dass die Tröge nicht als Stufe benutzt werden.
- Einseitige Sektionen müssen an der Wand befestigt werden. Es sind maximal drei ausziehbare Komponente pro Sektion erlaubt.
- Bei doppelseitigen Sektionen ist nur ein Trog pro Seite und Sektion erlaubt.
- Ausziehbare Tröge dürfen nicht in Regale mit Rollen montiert werden.

MONTAGE

Das Regalsystem Lingo wird flach verpackt geliefert. Sie finden Montageanweisungen auf unserer Website.

TECHNISCHE SPEZIFIKATIONEN

ALLGEMEINE SPEZIFIKATIONEN

RAHMENRAVERSE

Konfigurationen mit Rahmenraverse werden mit der notwendigen Anzahl von Traversen geliefert, je nach Höhe und Länge der Regalreihe, so daß eine ausreichende Stabilität gesichert wird. Wenn Sie Regale in einzelnen Teilen bestellen, bitte folgendes notieren:

Einseitig

Alle Höhe: eine Rahmenraverse pro Sektion bestellen.

Doppelseitig

H720/920/1220/1550 mm: eine Rahmenraverse pro Sektion bestellen.

H1820/2120 mm: folgendes bestellen:



1 doppelseitig Sektion
=
2 Rahmenraverse

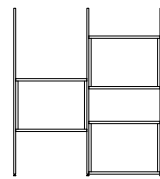

2 doppelseitige Sektionen
=
3 Rahmenraverse

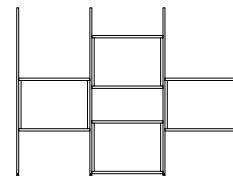

3 doppelseitige Sektionen
=
4 Rahmenraverse

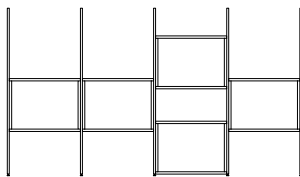

4 doppelseitige Sektionen
=
5 Rahmenraverse

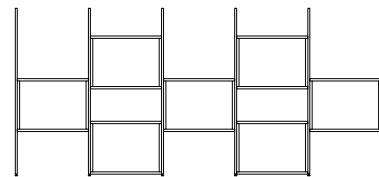

5 doppelseitige Sektionen
=
7 Rahmenraverse

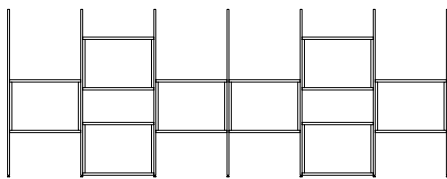

6 doppelseitige Sektionen
=
8 Rahmenraverse

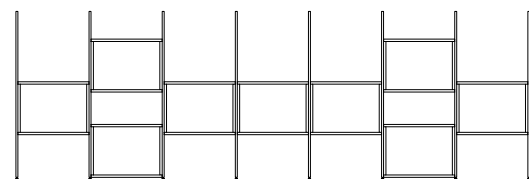

7 doppelseitige Sektionen
=
9 Rahmenraverse

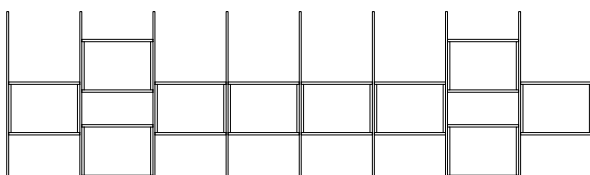

8 doppelseitige Sektionen
=
10 Rahmenraverse

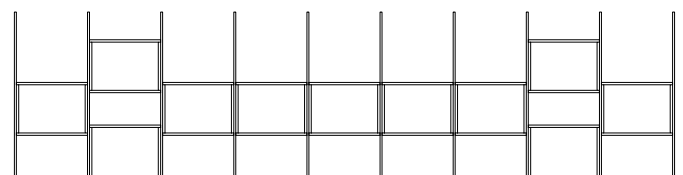

9 doppelseitige Sektionen
=
11 Rahmenraverse

TECHNISCHE SPEZIFIKATIONEN

TEILE AUS METALL

TEILE AUS METALL

sind pulverbeschichtet mit Standard polyesterbasiertem Pulver für hohe UV-Beständigkeit. Das Pulver entspricht EN 45545 (Brandschutz vergleichbar DIN 4201). Die Stärke der Beschichtung beträgt 60 – 80 µm.

Der Pulverlack enthält:

- Keine schwermetallhaltigen Pigmente wie Blei und Cadmium
- Kein Triglycidylisocyanurat (TGIC)
- Keine flüchtigen Anteile

Eine antibakterielle Ausführung der Oberflächen ist auf Anfrage möglich.

RAHMENRAVERSE

bestehen aus Stahlrohr, 30 x 15 x 2 mm. Die Metallrahmentraverse wird zwischen den Seiten- und Zwischenwänden problemlos montiert.

DIAGONALTRAVERSE

bestehen aus verzinktem Metall Ø 4 mm.

RÜCKWÄNDE

bestehen aus 0,9 mm Stahlblech.

METALLFACHBÖDEN UND TRÖGE

bestehen aus 0,9 mm Stahlblech. Die flachen Metallfachböden haben eine H25/47 mm vordere Kante. Flache Metallfachböden können dadurch in einer schrägen Position montiert werden, daß besondere Konsolen verwendet werden.

METALLKONSOLEN

bestehen aus 1,4 mm Stahlblech.

RAHMEN FÜR ROLLEN

bestehen aus:

sichtbare Rollen: 40 x 30 x 2 mm Stahlrohre. Die Endplatten bestehen aus 2 mm Stahlblech.

verdeckte Rollen: 30 x 30 x 2 mm Stahlrohre. Die Endplatten bestehen aus 2 mm Stahlblech, Sockel aus 0,9 mm Stahlblech.

GERADE SOCKELBLENDEN

bestehen aus 1,4 mm Stahlblech.

RUNDE SOCKELBLENDEN

bestehen aus 0,9 mm Stahlblech.

TECHNISCHE SPEZIFIKATIONEN

MELAMINBESCHICHTETE HOLZTEILE

MELAMINBESCHICHTETE HOLZTEILE

bestehen aus Spanplatte/Tischlerplatte.

SEITEN- UND ZWISCHENWÄNDE

bestehen aus 25 mm Spanplatte mit einer 2 mm ABS-Kante. Die Wände haben zwei Löcher für Stellfüße an der unteren Kante, mit Ausnahme von doppelseitigen Zwischenwänden mehr als 1220 mm hoch, die 4 Löcher für Stellfüße haben.

SEITENVERKLEIDUNGEN FÜR LINGO SQUARE

bestehen aus 25 mm Spanplatte.

RÜCKWÄNDE

bestehen aus 19 mm Spanplatte mit einer 2 mm ABS-Kante an den horizontalen Kanten.

FACHBÖDEN

W3 & W4 (Achismaß 500/750/900) bestehen aus 25 mm Spanplatte.

W3 & W4 (Achismaß 1000) bestehen aus 25 mm Tischlerplatte und sind Laminatbeschichtet, mit Ausnahme von Fachböden in Farbe D62, die melaminbeschichtet sind.

W7 und W8 bestehen aus 25 mm Spanplatte.

WT3 und WT7 bestehen aus 25 mm Spanplatte mit einer 2 mm ABS-Kante.

WO1 und WO5 bestehen aus 25 mm Spanplatte mit einer 2 mm ABS-Kante.

ROLLENPLATTEN

bestehen aus 25 mm Spanplatte mit einer 2 mm ABS-Kante.

SOCKEL

bestehen aus 25 mm Spanplatte mit einer 2 mm ABS-Kante an den horizontalen Kanten.

TECHNISCHE SPEZIFIKATIONEN

LACKIERTE HOLZTEILE

LACKIERTE HOLZTEILE

bestehen aus entweder

- Spanplatte mit einer lackierbaren Folie,
- MDF oder MDF Tischlerplatte, die mit Säurelack lackiert wird.

Standardteile haben einen Glanzgrad von 20 – 30. Siehe Designauswahl für Farbspezifikationen.

SEITEN- UND ZWISCHENWÄNDE

bestehen aus 25 mm Spanplatte/MDF mit einer 2 mm lackierbaren Folie. Die Wände haben zwei Löcher für Stellfüße an der unteren Kante, mit Ausnahme von doppelseitigen Zwischenwänden mehr als 1220 mm hoch, die 4 Löcher für Stellfüße haben.

LAMELLENWÄNDE

bestehen aus 25 mm MDF mit einer 2 mm lackierbaren Folie. Die Wände haben zwei Löcher für Stellfüße an der unteren Kante.

SEITENVERKLEIDUNGEN FÜR LINGO SQUARE

bestehen aus 25 mm MDF.

RÜCKWÄNDE

bestehen aus 19 mm MDF und sind auf allen Seiten und Kanten lackiert.

FACHBÖDEN

W1 & W2 bestehen aus 25 mm MDF Tischlerplatte

W5 und W6 bestehen aus 25 mm MDF Tischlerplatte.

WT1 und WT5 bestehen aus 25 mm Spanplatte oder MDF, mit einer 2 mm lackierbaren ABS-Kante.

WO1 und WO5 bestehen aus 25 mm Spanplatte oder MDF, mit einer 2 mm lackierbaren ABS-Kante.

ROLLENPLATTEN

bestehen aus Spanplatte oder MDF, mit einer 2 mm lackierbaren ABS-Kante.

SOCKEL

bestehen aus 25 mm Spanplatte mit einer lackierbaren Folie/MDF und mit 2 mm lackierbaren ABS-Kanten an den horizontalen Kanten.

TECHNISCHE SPEZIFIKATIONEN

FURNIERTE HOLZTEILE

FURNIERTE HOLZTEILE

sind hauptsächlich mit umweltfreundlich UV-Lack lackiert.

SEITEN- UND ZWISCHENWÄNDE

bestehen aus 25 mm Spanplatte und sind mit 0,6 mm Furnier furniert. Alle Kanten haben eine 2 mm Furnierkante. Die Wände haben 2 Bohrungen für einstellbare Füße, ausgenommen die doppelseitigen Zwischenwände über 1220 mm, diese haben 4 Bohrungen für einstellbare Füße.

LAMELLENWÄNDE

bestehen aus 25 mm MDF und sind mit 0,6 mm Furnier furniert. Alle Kanten haben eine 2 mm Furnierkante. Die Wände haben zwei Löcher für Stellfüße an der unteren Kante.

SEITENVERKLEIDUNGEN FÜR LINGO SQUARE

bestehen aus 25 mm MDF und sind mit 0,6 mm Furnier furniert. Alle Kanten haben eine 2 mm Furnierkante.

RÜCKWÄNDE

bestehen aus 19 mm Spanplatte und sind mit 0,6 mm Furnier furniert. Die horizontalen Kanten haben eine 2 mm Furnierkante. Die vertikalen Kanten sind unbeschichtet, weil sie nach Montage nicht sichtbar sind.

FACHBÖDEN

W1 & W2 bestehen aus 25 mm Tischlerplatte und sind mit 0,6 mm Furnier furniert. Die vordere und die hintere Kante haben eine 2 mm Furnierkante.

W5 und W6 bestehen aus 25 mm Tischlerplatte mit 0,6 mm Furnier. Die vordere und die hintere Kante haben eine 2 mm Furnierkante.

WT1 und WT5 bestehen aus 25 mm Spanplatte mit 0,6 mm Furnier. Die vordere und die hintere Kante haben eine 2 mm Furnierkante.

WO1 und WO5 bestehen aus 25 mm Spanplatte mit 0,6 mm Furnier. Die vordere und die hintere Kante haben eine 2 mm Furnierkante.

ROLLENPLATTEN

bestehen aus of 25 mm Spanplatte mit 0,6 mm Furnier. Alle Kanten der Rollenplatten haben eine 2 mm Furnierkante.

SOCKEL

bestehen aus 25 mm Spanplatte und sind mit 0,6 mm Furnier an der vorderen Kante furniert. Die vordere und die hintere Kante haben eine 2 mm Furnierkante.

MAßE

REGALSYSTEM LINGO



Der Abstand zwischen der Vorderkante der Regalseite und der Vorderkante des Fachbodens beträgt 7 mm. Die Fachböden sind höhenverstellbar im Abstand von 25 mm.

Konfigurationen des Regalsystems Lingo werden in der Standardausführung nach Preisgruppe A geliefert (melaminbeschichtet/lackiert/furniert). Siehe Seiten 6-9 für Designauswahl.

HÖHEN

Lingo Regalsystem ist in 5 Höhen lieferbar; 720, 920, 1220, 1520 und 2120 mm. Die Höhenangaben umfassen auch die Stellfüße/Rollenset/Bodenplatte mit Rollen.

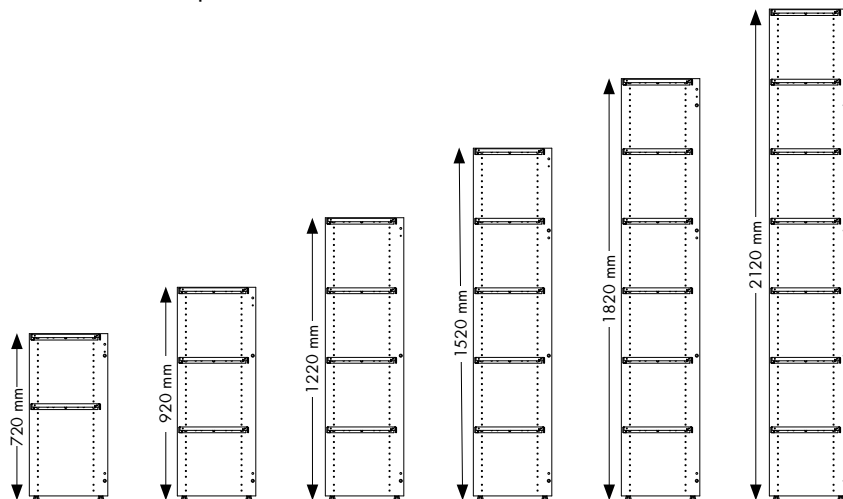

BREITEN

Lingo Regalsystem ist in 4 Breiten lieferbar; 500, 750, 900 und 1000 mm.

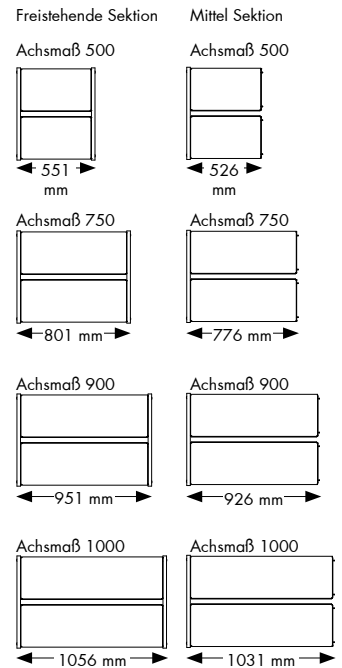

TIEFEN

Lingo Regalsystem ist in 2 x 3 Tiefen lieferbar; 250, 300 und 400 mm
2 x 250, 2 x 300 und 2 x 400 mm

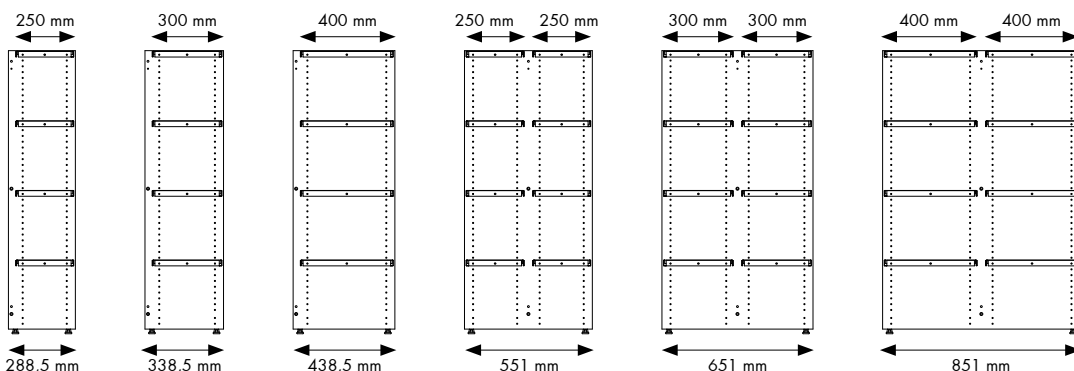



Der Abstand zwischen der Vorderkante der Regalseite und der Vorderkante des Fachbodens beträgt 7 mm. Die Fachböden sind höhenverstellbar im Abstand von 25 mm.

Konfigurationen des Regalsystems Lingo Square werden in der Standardausführung nach Preisgruppe A geliefert (melaminbeschichtet/lackiert/furniert). Siehe Seiten 6-9 für Designauswahl.

HÖHEN

Lingo Square ist in 4 Höhen lieferbar: 920, 1220, 1520 und 1820 mm.

Die Höhenangaben umfassen auch die Stellfüße/Bodenplatte mit Rollen.

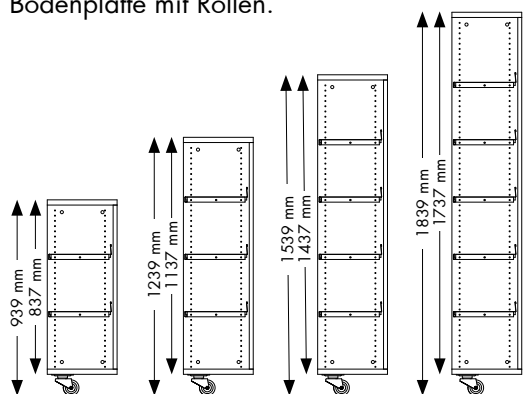

BREITEN

Lingo Square ist in 3 Breiten lieferbar: 500, 750 und 900 mm.

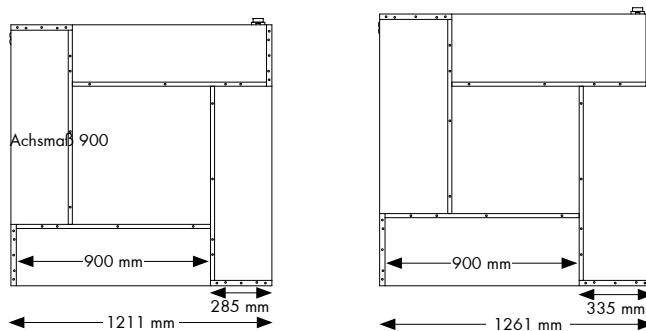
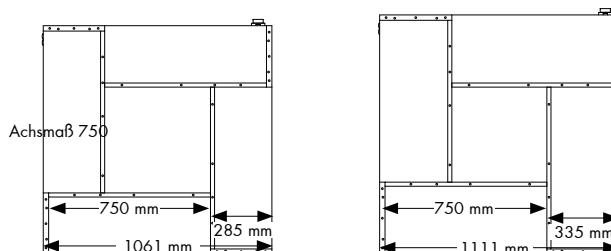
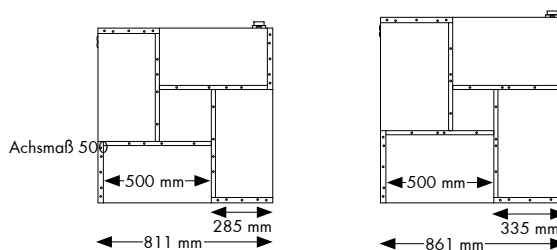

TIEFEN

Lingo Square ist in 2 Tiefen lieferbar: 250 und 300 mm

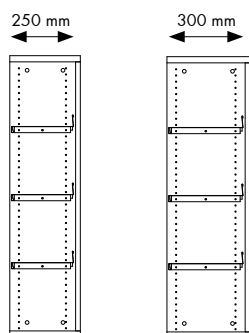

MAßE

REGALSYSTEM LINGO RUND

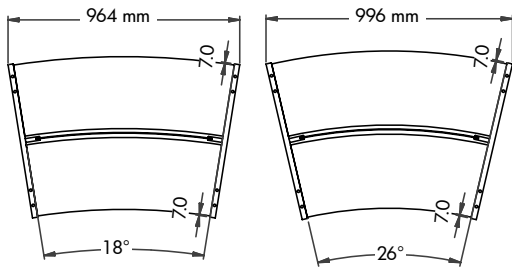

Der Abstand zwischen der vorderen Kante der Regalseite und der vorderen Kante des Fachbodens beträgt 7 mm. Die Fachböden sind höhenverstellbar im Abstand von 25 mm.

Konfigurationen des Regalsystems Lingo Rund werden in der Standardausführung nach Preisgruppe A geliefert (melaminbeschichtet/lackiert/furniert). Siehe Seiten 6-9 für Designauswahl.

HEIGHTS

Lingo Rund ist in 6 Höhen lieferbar: 720, 920, 1220, 1520, 1820 and 2120 mm.

Die Höhenangaben umfassen auch die Stellfüße/ Bodenplatte mit Rollen.

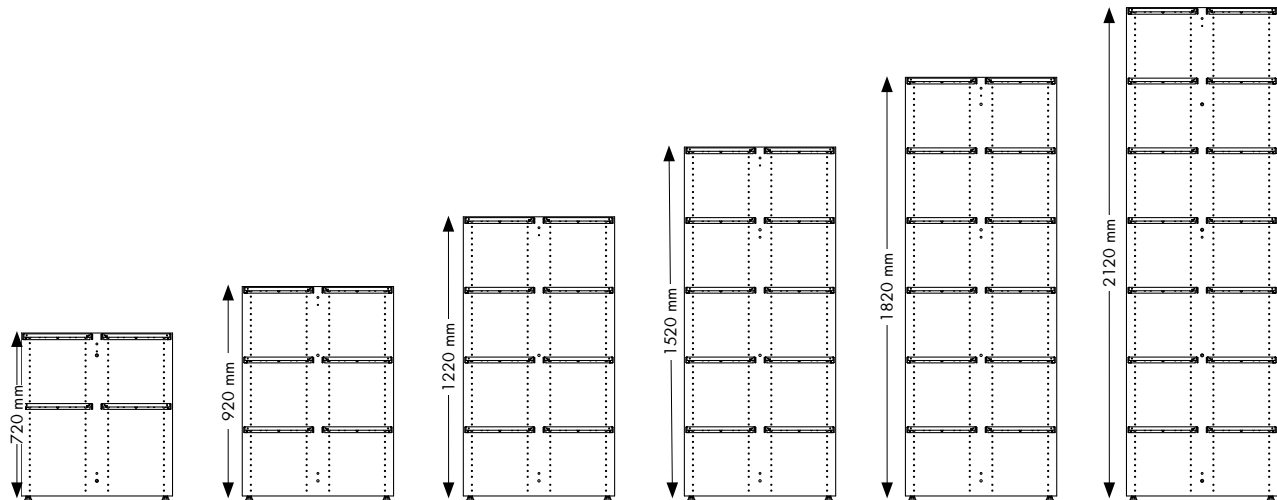

TIEFEN

Lingo Rund ist in einer Tiefe lieferbar: 2 x 300 mm.

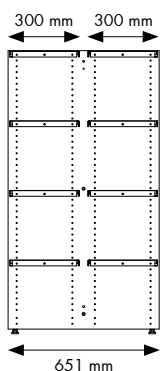

LINGO RUND 26°

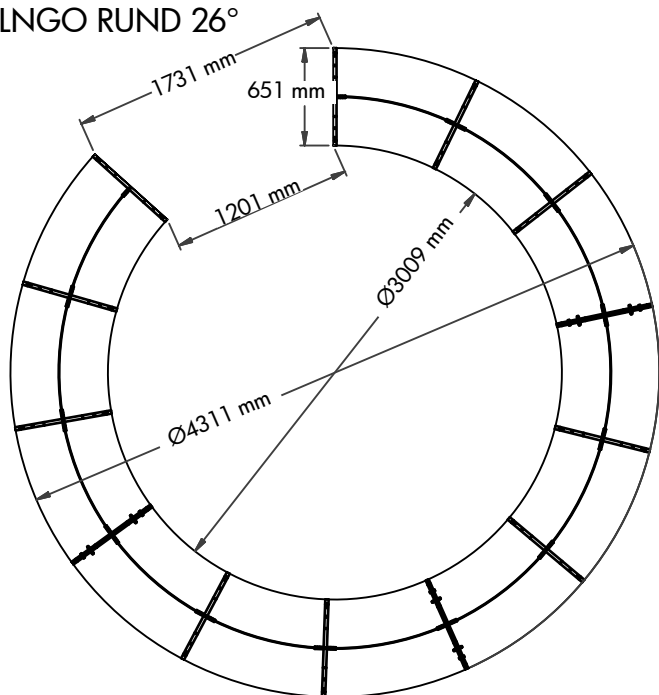

LINGO RUND 18°

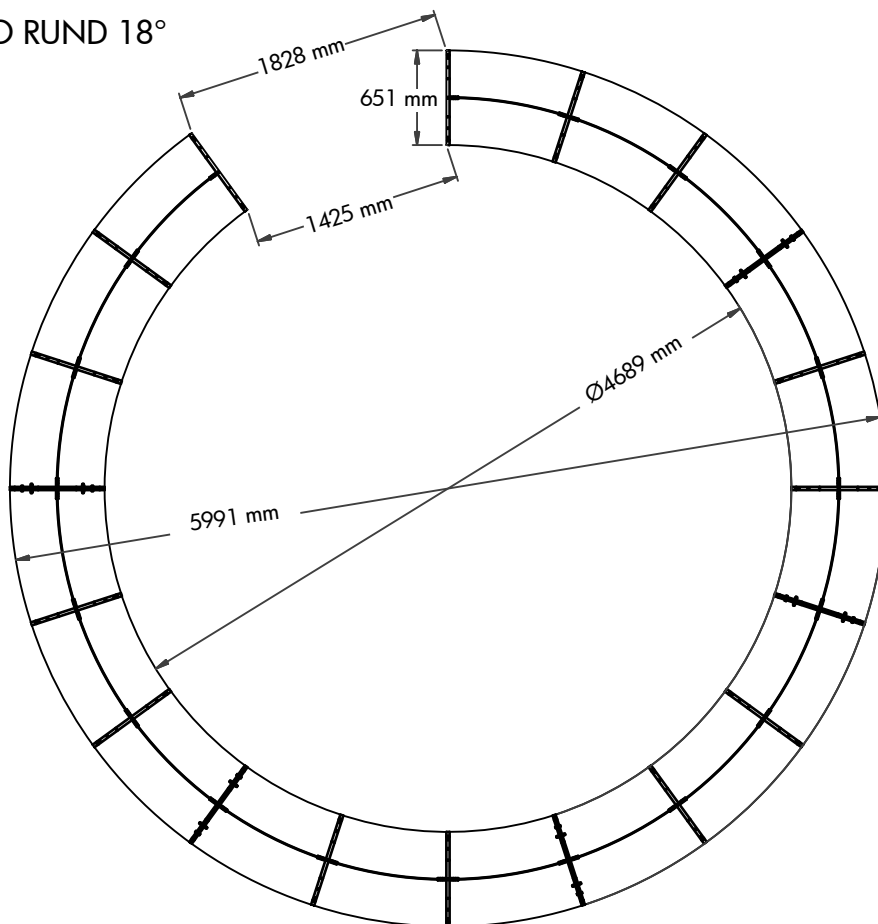

SEKTIONSBAUWEISE

FREISTEHENDE UND MITTLERE SEKTIONEN BBN001/BBN201/BBN221

Eine freistehende Sektion besteht aus einer rechten und einer linken Regalseite mit Löchern auf der Innenseite. Um eine weitere Sektion hinzuzufügen, müssen Sie die rechte Regalseite abnehmen, die Mittelsektion einsetzen (Regalseite mit Löchern auf beiden Seiten) und die rechte Regalseite der freistehenden Sektion an der Mittelsektion befestigen. Siehe Beispiel unten und Konfiguration Nr. 5 auf Seite 29.

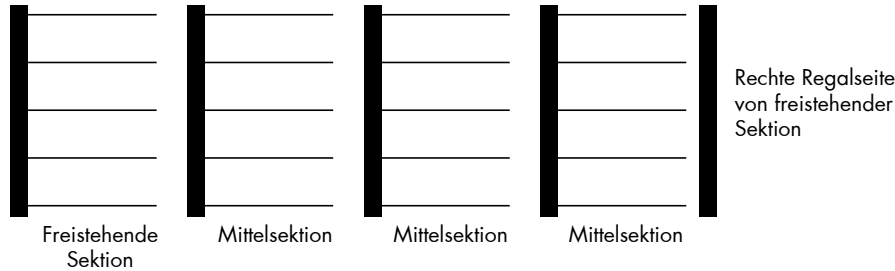

OBENLIEGENDE ABDECKPLATTEN FÜR GERADE SEKTIONEN MIT STELLFÜßEN

Eine gerade Abdeckplatte hat eine maximale Länge von 2750 mm.

Wenn Sie ein Regalsystem mit 1, 2 oder 3 Sektionen bauen, können Sie nur eine freistehende Abdeckplatte verwenden (je nach Modulgröße).

Wenn Sie ein Regalsystem mit mehr als 3 Sektionen bauen, werden die Abdeckplatten aus einer Kombination von äußeren und mittleren Abdeckplatten bestehen.

Freistehende Abdeckplatte aus Holz

Wird immer für 1 Sektion verwendet und kann für 1, 2 oder 3 Sektionen verwendet werden. Die Abdeckplatte deckt die Regalseiten an beiden Enden ab.

Gesamtbreite mm				
Module	500	750	900	1000
1 Sekt.	551	801	951	1056
2 Sekt.	1078	1578	1878	2088
3 Sekt.	1604	2354	-	-

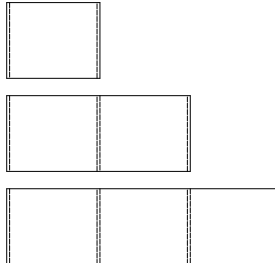

Äußere Abdeckplatte aus Holz

Kann für 1, 2 oder 3 Sektionen in Kombination mit äußeren oder mittleren Abdeckplatten verwendet werden. Die Abdeckplatte deckt eine Regalseite ab.

Gesamtbreite mm				
Module	500	750	900	1000
1 Sekt.	539	789	939	1044
2 Sekt.	1065	1565	1865	2075
3 Sekt.	1592	2342	-	-

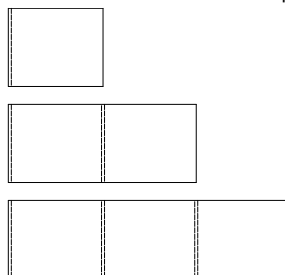

Mittlere Abdeckplatte aus Holz

Kann für 1, 2 oder 3 Sektionen in Kombination mit äußeren oder mittleren Abdeckplatten verwendet werden. Die Abdeckplatte deckt nur die mittlere Regalseite ab.

Gesamtbreite mm				
Module	500	750	900	1000
1 Sekt.	526	776	926	1031
2 Sekt.	1053	1553	1853	2063
3 Sekt.	1829	2329	-	-

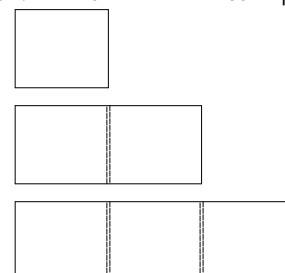

SEKTIONSBAUWEISE

OBENLIEGENDE ABDECKPLATTEN FÜR RUNDE SEKTIONEN MIT STELLFÜßEN

Wenn Sie ein Regalsystem mit 1, 2 oder 3 Sektionen bauen, können Sie nur eine freistehende Abdeckplatte verwenden.

Wenn Sie ein Regalsystem mit mehr als 3 Sektionen bauen, werden die Abdeckplatten aus einer Kombination von äußeren und mittleren Abdeckplatten bestehen.

Freistehende Abdeckplatte aus Holz

Wird immer für 1 Sektion verwendet und kann für 1, 2 oder 3 Sektionen verwendet werden. Die Abdeckplatte deckt die Regalseiten an beiden Enden ab.

Dimensions mm				
Bay	26°x	26°y	18°x	18°y
1 Sekt.	994	692	962	682
2 Sekt.	1912	809	1875	770
3 Sekt.	2732	994	2742	912

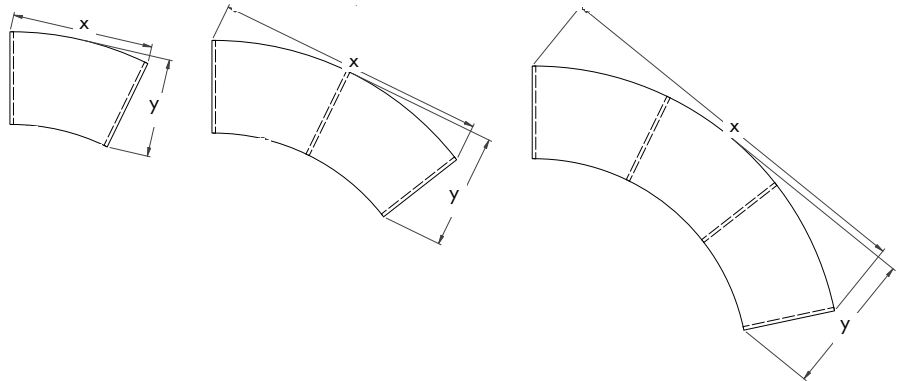

Linke/rechte Anfang/End Abdeckplatte aus Holz

Kann für 1, 2 oder 3 Sektionen in Kombination mit äußeren oder mittleren Abdeckplatten verwendet werden. Die Abdeckplatte deckt eine Regalseite ab.

Dimensions mm				
Bay	26°x	26°y	18°x	18°y
1 Sekt.	982	691	951	682
2 Sekt.	1901	806	1861	770
3 Sekt.	2723	990	2731	912

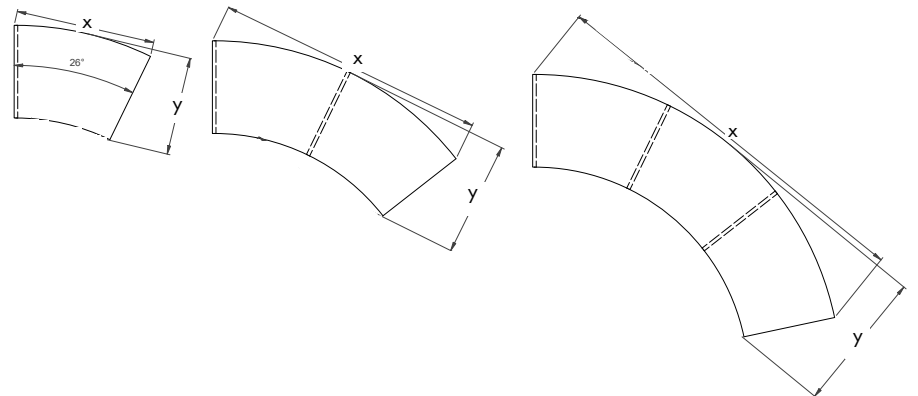

Mittlere Abdeckplatte aus Holz

Kann für 1, 2 oder 3 Sektionen in Kombination mit äußeren oder mittleren Abdeckplatten verwendet werden. Die Abdeckplatte deckt nur die mittlere Regalseite ab.

Dimensions mm				
Bay	26°x	26°y	18°x	18°y
1 Sekt.	982	691	940	677
2 Sekt.	1901	806	1853	765
3 Sekt.	2723	990	2720	907

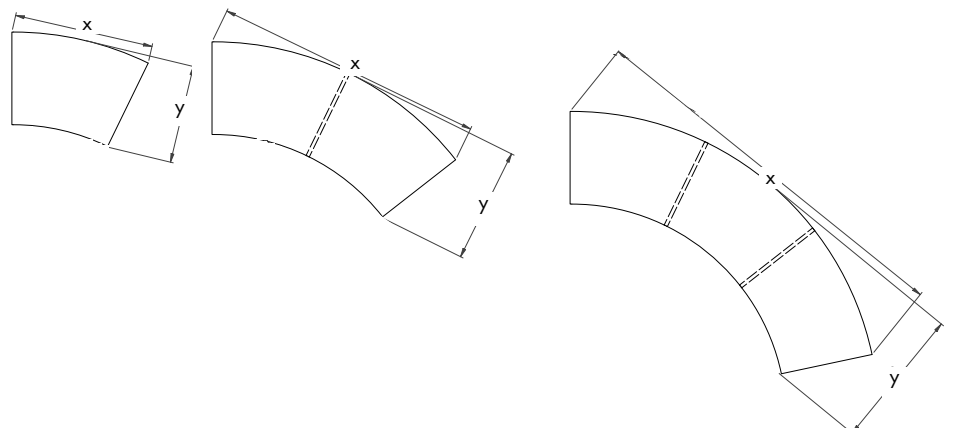

SEKTIONSBAUWEISE

LINKE/RECHTE ANFANG/END RUNDE SEKTIONEN

Wenn Sie ein rundes Lingo-Regalsystem mit Stellfüßen und Abdeckplatte (BBN202/BBN222) konstruieren, müssen Sie das Regal von der Innenseite der Kurve aus betrachten, um festzustellen, welches Teilstück für das komplette Regalsystem benötigt wird. Das bedeutet, dass Sie die Position ändern müssen, um die richtigen Sektionen zu finden und Ihre endgültige Regalkonfiguration zu entwerfen.

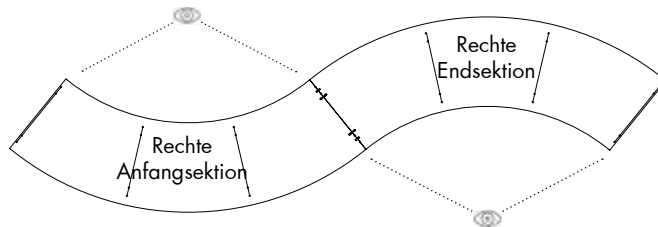
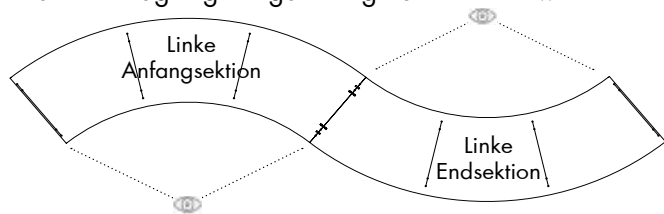

LINKE ANFANGSEKTION

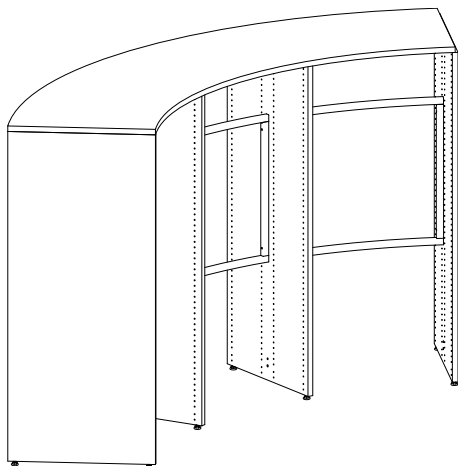

Die linke Anfangssection beginnt mit einer linken Regalseite und endet mit einer mittleren Regalseite.

RECHTE ANFANGSEKTION

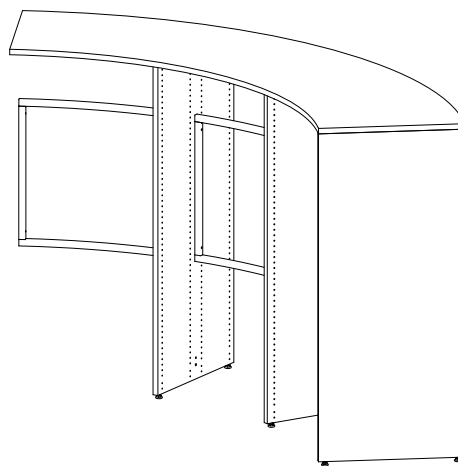

Die Rechte Anfangssection beginnt mit einer rechten Regalseite und endet mit einer mittleren Regalseite

LINKE ENDSEKTION

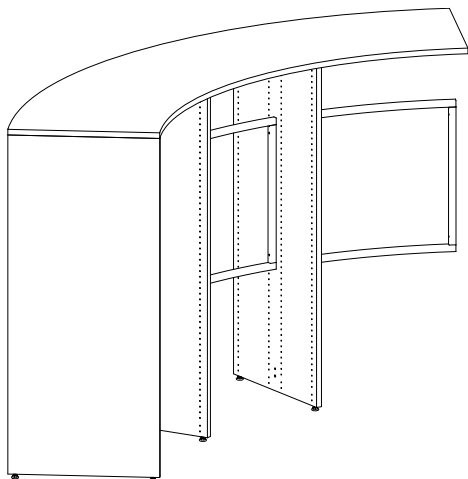

Die linke Endsection beginnt ohne Mittlere Regalseite und endet mit einer linken Regalseite.

RECHTE ENDSEKTION

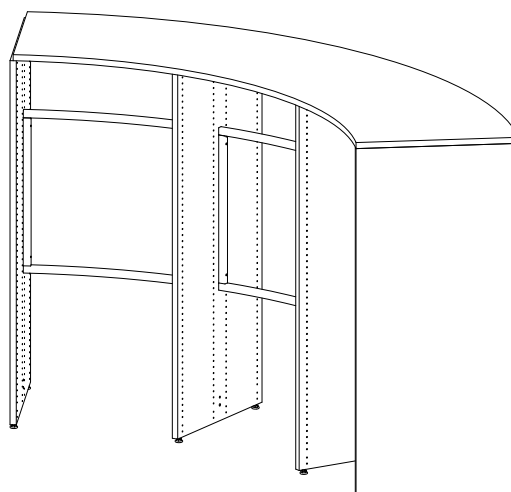

Die rechte Endsection beginnt ohne mittlere Regalseite und endet mit einer rechten Regalseite.

SEKTIONSBAUWEISE

MITTELSEKTIONEN

Wenn Sie ein rundes Lingo-Regalsystem mit Stellfüßen und Abdeckplatte (BBN202/BBN222) über mehr als 3 Sektionen bauen, ist es notwendig, eine Mittelsektion zwischen den Anfang- und Endsektionen einzufügen.

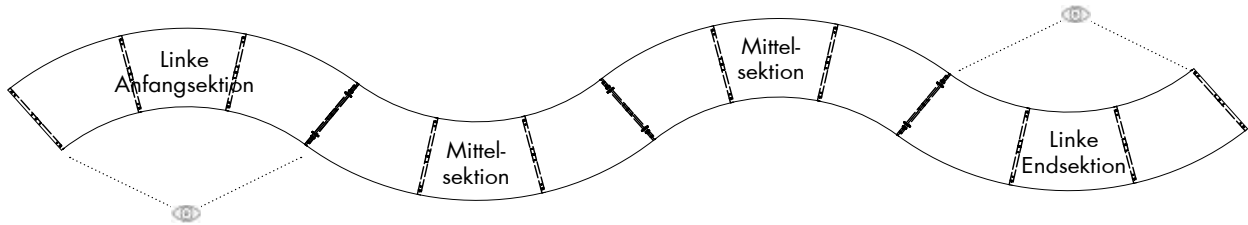

MITTELSEKTION

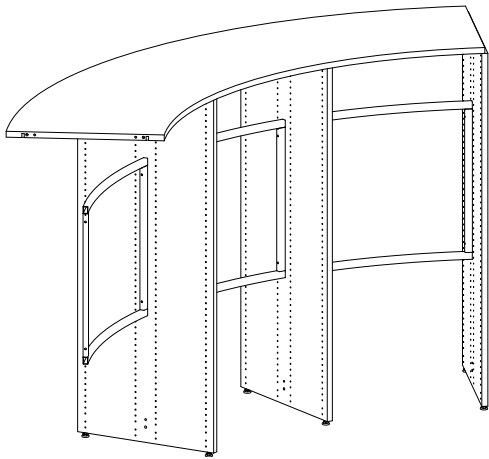

Eine Mittelsektion beginnt ohne mittlere Regalseite und endet mit einer mittleren Regalseite.

GERADE UND RUNDE KOMBINATIONEN

KOMBINATION VON GERADEN UND RUNDEN REGALEN

Es ist möglich, runde und gerade Regale zu kombinieren, um einzigartige Regale zu schaffen - je nach den Platzverhältnissen vor Ort, der benötigten Regalkapazität und dem Design.

SEKTIONEN AUF STELLFÜSSEN

Bei der Konstruktion von Rundregalen gibt es aufgrund des Winkels der gesamten Anzahl der Sektionen Einschränkungen zu beachten. Die Übersicht zeigt die maximale Anzahl der Sektionen, die in einem durchgehenden Regalsystem gebaut werden können, bevor Sie den Winkel/die Richtung des Regals ändern müssen.

	Anzahl der verbundenen Sektionen möglich in freistehender Kombination	Anzahl der verbundenen Sektionen möglich in linke/rechte Anfangssection	Anzahl der verbundenen Sektionen möglich in Mittelsektion	Anzahl der verbundenen Sektionen möglich in linke/rechte Endsection
26°	Bis 12 Sektionen	Insgesamt 9 Sektionen	7 Sektionen	Insgesamt 9 Sektionen
18°	Bis 18 Sektionen	Insgesamt 13 Sektionen	10 Sektionen	Insgesamt 13 Sektionen
Straight	Bis 9 Sektionen	Insgesamt 9 Sektionen	9 Sektionen	Insgesamt 9 Sektionen

SEKTIONEN AUF ROLLENPLATTE

Die obige Übersicht gilt auch für Sektionen auf Rollenplatten, allerdings werden die Rollenplatten in maximal 3 Sektionen und nicht in einem durchgehenden Regalsystem aufgebaut.

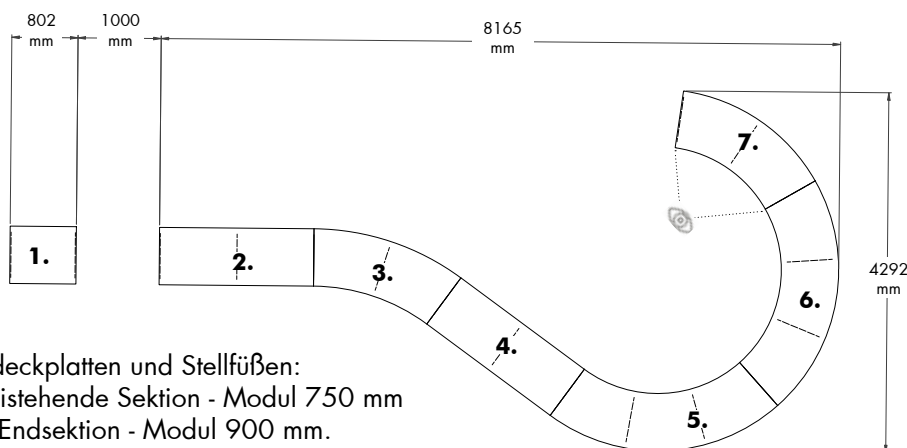

KONFIGURATION NR. 1

Besteht aus 15 Sektionen mit 7 Abdeckplatten und Stellfüßen:

- 1: BBN002 - 1 Sektion - gerade freistehende Sektion - Modul 750 mm
- 2: BBN002 - 2 Sektionen - gerade Endsection - Modul 900 mm.
- 3: BBN222 - 2 Sektionen - 18° Mittelsektion
- 4: BBN002 - 2 Sektionen - gerade Mittelsektion - Modul 900 mm
- 5: BBN202 - 3 Sektionen - 26° Mittelsektion
- 6: BBN202 - 3 Sektionen - 26° Mittelsektion
- 7: BBN202 - 2 Sektionen - 26° linke Endsection

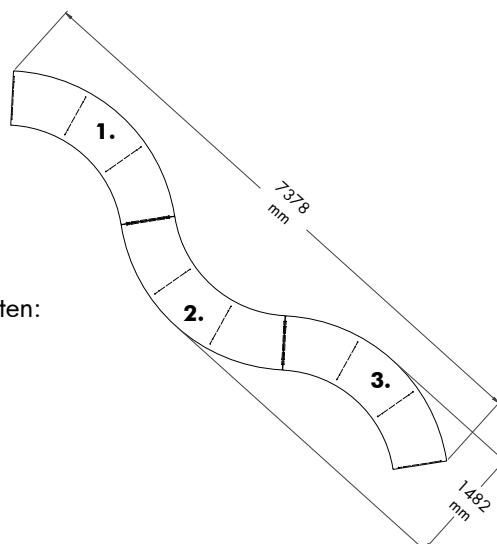

KONFIGURATION NR. 2

Besteht aus 9 Sektionen mit 3 Abdeckplatten und 3 Rollenplatten:

- 1: BBN212 - 3 Sektionen - 26° freistehende Sektion
- 2: BBN212 - 3 Sektionen - 26° Freistehende Sektion
- 3: BBN212 - 3 Sektionen - 26° freistehende Sektion-

GERADE UND RUNDE KOMBINATIONEN

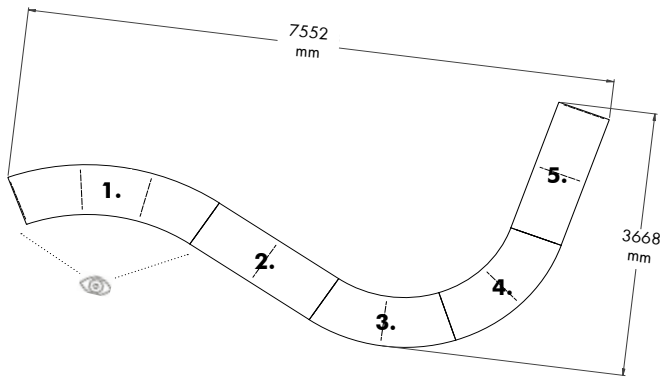

KONFIGURATION NR. 3

Besteht aus 11 Sektionen mit 5 Abdeckplatten und Stellfüßen:

- 1: BBN222 - 3 Sektionen - 18° linke Anfangssection
- 2: BBN002 - 2 Sektionen - gerade Mittelsektion - Modul 900 mm
- 3: BBN202 - 2 Sektionen - 26° Mittelsektion
- 4: BBN202 - 2 Sektionen - 26° Mittelsektion
- 5: BBN002 - 2 Sektionen - gerade Endsektion - Modul 900 mm

KONFIGURATION NR. 4

Besteht aus 15 Sektionen mit 5 Abdeckplatten und 5 Rollenplatten:

- 1: BBN232 - 3 Sektionen - 18° freistehende Sektion
- 2: BBN232 - 3 Sektionen - 18° freistehende Sektion
- 3: BBN232 - 3 Sektionen - 18° freistehende Sektion
- 4: BBN232 - 3 Sektionen - 18° freistehende Sektion
- 5: BBN232 - 3 Sektionen - 18° freistehende Sektion

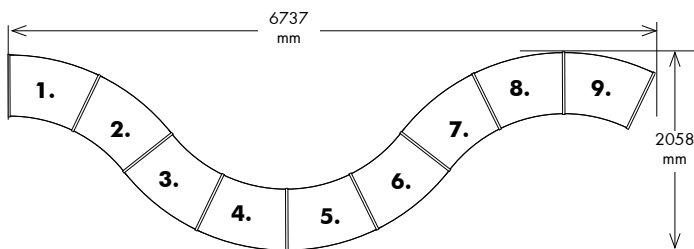
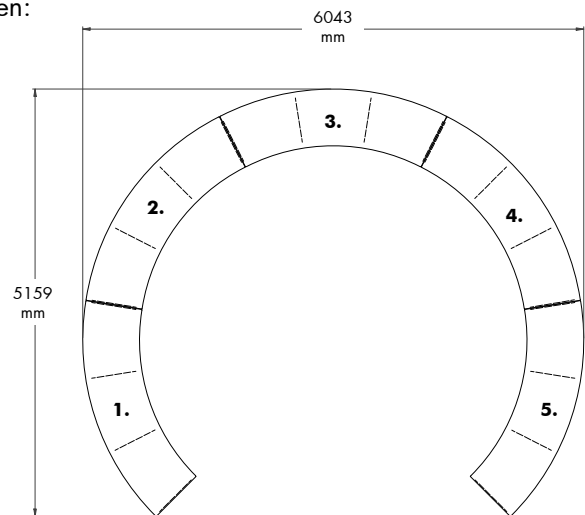

KONFIGURATION NR. 5

Besteht aus 9 Sektionen mit Abdeckfachböden aus Holz und Stellfüßen:

- 1: BBN201 - 1 Sektion - 26° freistehende Sektionen
- 2-9: BBN201 - 8 Sektionen - 26° Mittelsektionen

LINGO REGALSYSTEM

BBN001 - RAHMEN TRAVVERSE - STELLFÜßE - FÜR ABDECKFACHBODEN



LINGO REGALSYSTEM

BBN001 - RAHMENTRAVERSE - STELLFÜßE - FÜR ABDECKFACHBODEN

Regalsystem mit Holzseiten und Metallrahmen traverse. Zur Verwendung mit Abdeckboden. Freistehende Sektion beinhaltet 2 Seitenwände und 1 oder 2 Metallrahmen traversen je nach Höhe. Mittlere Sektion beinhaltet 1 Zwischenseite und 1 Metallrahmen traverse.

- Preis basiert auf Metallpreisgruppe 1 und Holzpreisgruppe A (siehe Designauswahl Seiten 6-9).
- Für Fachböden siehe Seite 128.
- Für Funktionen siehe Seite 168.

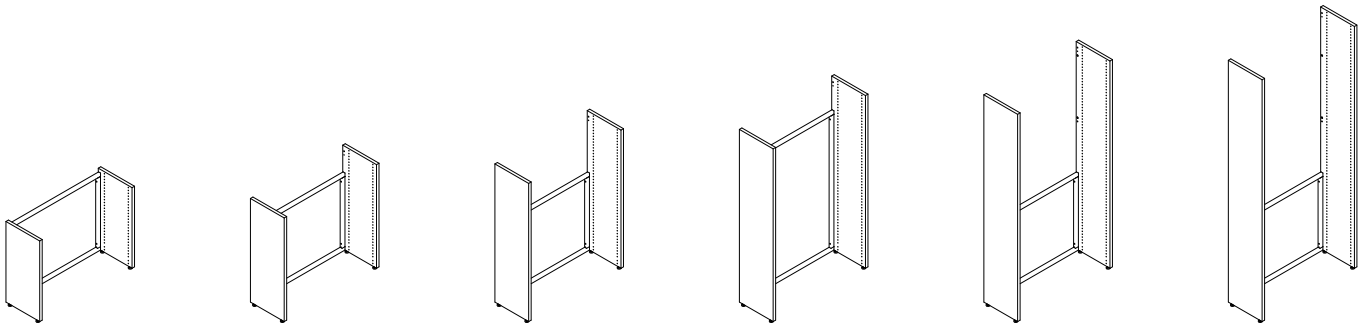

Einseitige freistehende Sektion - H720/920/1220/1520/1820/2120 mm

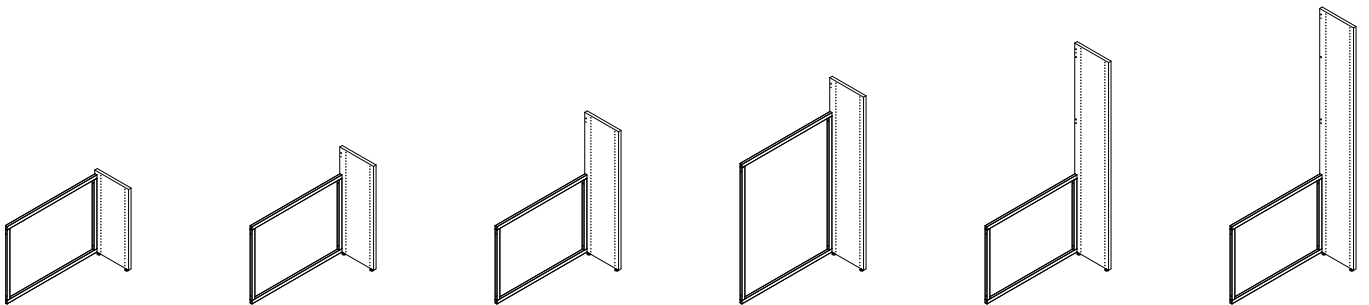

Einseitige mittlere Sektion - H720/920/1220/1520/1820/2120 mm

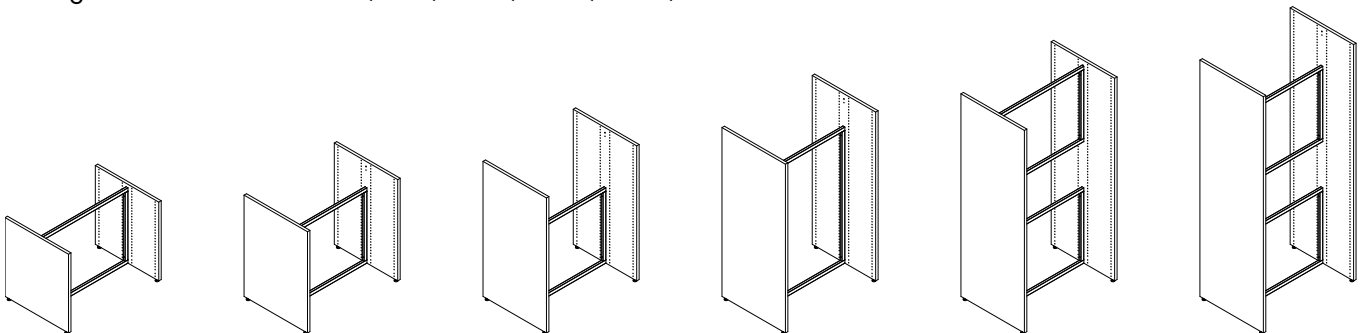

Doppelseitige freistehende Sektion - H720/920/1220/1520/1820/2120 mm

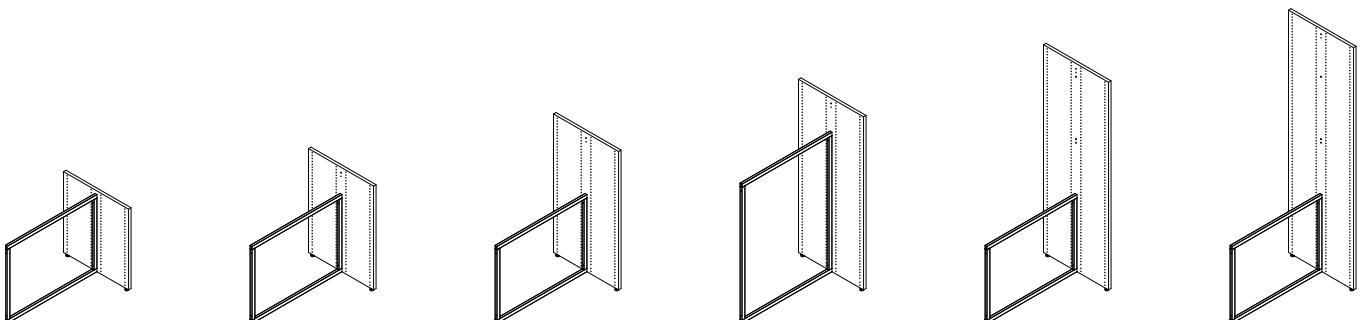

Doppelseitige mittlere Sektion - H720/920/1220/1520/1820/2120 mm

LINGO REGALSYSTEM

EINSEITIG - RAHMENRAVERSE - STELLFÜßE - FÜR ABDECKFACHBODEN

Lackierte und furnierte Lingo Regale haben das FSC Zertifikat.

H720 mm

Achismaß mm	FB Tiefe mm	Bestell-Nr. Freistehendes Regal	Melamin EUR	Lackiert EUR	Furniert EUR	Bestell-Nr. Mittel Regal	Melamin EUR	Lackiert EUR	Furniert EUR
500	250	BBN001235510160000.	-	-	-	BBN001235320160000.	-	-	-
500	300	BBN001255510160000.	-	-	-	BBN001255320160000.	-	-	-
500	400	BBN001275510160000.	-	-	-	BBN001275320160000.	-	-	-
750	250	BBN001237510160000.	-	-	-	BBN001237320160000.	-	-	-
750	300	BBN001257510160000.	-	-	-	BBN001257320160000.	-	-	-
750	400	BBN001277510160000.	-	-	-	BBN001277320160000.	-	-	-
900	250	BBN001239510160000.	-	-	-	BBN001239320160000.	-	-	-
900	300	BBN001259510160000.	-	-	-	BBN001259320160000.	-	-	-
900	400	BBN001279510160000.	-	-	-	BBN001279320160000.	-	-	-
1000	250	BBN001231510160000.	-	-	-	BBN001231320160000.	-	-	-
1000	300	BBN001251510160000.	-	-	-	BBN001251320160000.	-	-	-
1000	400	BBN001271510160000.	-	-	-	BBN001271320160000.	-	-	-

H920 mm

Achismaß mm	FB Tiefe mm	Bestell-Nr. Freistehendes Regal	Melamin EUR	Lackiert EUR	Furniert EUR	Bestell-Nr. Mittel Regal	Melamin EUR	Lackiert EUR	Furniert EUR
500	250	BBN001335510160000.	-	-	-	BBN001335320160000.	-	-	-
500	300	BBN001355510160000.	-	-	-	BBN001355320160000.	-	-	-
500	400	BBN001375510160000.	-	-	-	BBN001375320160000.	-	-	-
750	250	BBN001337510160000.	-	-	-	BBN001337320160000.	-	-	-
750	300	BBN001357510160000.	-	-	-	BBN001357320160000.	-	-	-
750	400	BBN001377510160000.	-	-	-	BBN001377320160000.	-	-	-
900	250	BBN001339510160000.	-	-	-	BBN001339320160000.	-	-	-
900	300	BBN001359510160000.	-	-	-	BBN001359320160000.	-	-	-
900	400	BBN001379510160000.	-	-	-	BBN001379320160000.	-	-	-
1000	250	BBN001331510160000.	-	-	-	BBN001331320160000.	-	-	-
1000	300	BBN001351510160000.	-	-	-	BBN001351320160000.	-	-	-
1000	400	BBN001371510160000.	-	-	-	BBN001371320160000.	-	-	-

H1220 mm

Achismaß mm	FB Tiefe mm	Bestell-Nr. Freistehendes Regal	Melamin EUR	Lackiert EUR	Furniert EUR	Bestell-Nr. Mittel Regal	Melamin EUR	Lackiert EUR	Furniert EUR
500	250	BBN001435510160000.	-	-	-	BBN001435320160000.	-	-	-
500	300	BBN001455510160000.	-	-	-	BBN001455320160000.	-	-	-
500	400	BBN001475510160000.	-	-	-	BBN001475320160000.	-	-	-
750	250	BBN001437510160000.	-	-	-	BBN001437320160000.	-	-	-
750	300	BBN001457510160000.	-	-	-	BBN001457320160000.	-	-	-
750	400	BBN001477510160000.	-	-	-	BBN001477320160000.	-	-	-
900	250	BBN001439510160000.	-	-	-	BBN001439320160000.	-	-	-
900	300	BBN001459510160000.	-	-	-	BBN001459320160000.	-	-	-
900	400	BBN001479510160000.	-	-	-	BBN001479320160000.	-	-	-
1000	250	BBN001431510160000.	-	-	-	BBN001431320160000.	-	-	-
1000	300	BBN001451510160000.	-	-	-	BBN001451320160000.	-	-	-
1000	400	BBN001471510160000.	-	-	-	BBN001471320160000.	-	-	-

LINGO REGALSYSTEM

EINSEITIG - RAHMENTRAVERSE - STELLFÜßE - FÜR ABDECKFACHBODEN

Lackierte und furnierte Lingo Regale haben das FSC Zertifikat.

H1520 mm

Achismaß mm	FB Tiefe mm	Bestell-Nr. Freistehendes Regal	Melamin EUR	Lackiert EUR	Furniert EUR	Bestell-Nr. Mittel Regal	Melamin EUR	Lackiert EUR	Furniert EUR
500	250	BBN001535510160000.	-	-	-	BBN001535320160000.	-	-	-
500	300	BBN001555510160000.	-	-	-	BBN001555320160000.	-	-	-
500	400	BBN001575510160000.	-	-	-	BBN001575320160000.	-	-	-
750	250	BBN001537510160000.	-	-	-	BBN001537320160000.	-	-	-
750	300	BBN001557510160000.	-	-	-	BBN001557320160000.	-	-	-
750	400	BBN001577510160000.	-	-	-	BBN001577320160000.	-	-	-
900	250	BBN001539510160000.	-	-	-	BBN001539320160000.	-	-	-
900	300	BBN001559510160000.	-	-	-	BBN001559320160000.	-	-	-
900	400	BBN001579510160000.	-	-	-	BBN001579320160000.	-	-	-
1000	250	BBN001531510160000.	-	-	-	BBN001531320160000.	-	-	-
1000	300	BBN001551510160000.	-	-	-	BBN001551320160000.	-	-	-
1000	400	BBN001571510160000.	-	-	-	BBN001571320160000.	-	-	-

H1820 mm

Achismaß mm	FB Tiefe mm	Bestell-Nr. Freistehendes Regal	Melamin EUR	Lackiert EUR	Furniert EUR	Bestell-Nr. Mittel Regal	Melamin EUR	Lackiert EUR	Furniert EUR
500	250	BBN001635510160000.	-	-	-	BBN001635320160000.	-	-	-
500	300	BBN001655510160000.	-	-	-	BBN001655320160000.	-	-	-
500	400	BBN001675510160000.	-	-	-	BBN001675320160000.	-	-	-
750	250	BBN001637510160000.	-	-	-	BBN001637320160000.	-	-	-
750	300	BBN001657510160000.	-	-	-	BBN001657320160000.	-	-	-
750	400	BBN001677510160000.	-	-	-	BBN001677320160000.	-	-	-
900	250	BBN001639510160000.	-	-	-	BBN001639320160000.	-	-	-
900	300	BBN001659510160000.	-	-	-	BBN001659320160000.	-	-	-
900	400	BBN001679510160000.	-	-	-	BBN001679320160000.	-	-	-
1000	250	BBN001631510160000.	-	-	-	BBN001631320160000.	-	-	-
1000	300	BBN001651510160000.	-	-	-	BBN001651320160000.	-	-	-
1000	400	BBN001671510160000.	-	-	-	BBN001671320160000.	-	-	-

H2120 mm

Achismaß mm	FB Tiefe mm	Bestell-Nr. Freistehendes Regal	Melamin EUR	Lackiert EUR	Furniert EUR	Bestell-Nr. Mittel Regal	Melamin EUR	Lackiert EUR	Furniert EUR
500	250	BBN001735510160000.	-	-	-	BBN001735320160000.	-	-	-
500	300	BBN001755510160000.	-	-	-	BBN001755320160000.	-	-	-
500	400	BBN001775510160000.	-	-	-	BBN001775320160000.	-	-	-
750	250	BBN001737510160000.	-	-	-	BBN001737320160000.	-	-	-
750	300	BBN001757510160000.	-	-	-	BBN001757320160000.	-	-	-
750	400	BBN001777510160000.	-	-	-	BBN001777320160000.	-	-	-
900	250	BBN001739510160000.	-	-	-	BBN001739320160000.	-	-	-
900	300	BBN001759510160000.	-	-	-	BBN001759320160000.	-	-	-
900	400	BBN001779510160000.	-	-	-	BBN001779320160000.	-	-	-
1000	250	BBN001731510160000.	-	-	-	BBN001731320160000.	-	-	-
1000	300	BBN001751510160000.	-	-	-	BBN001751320160000.	-	-	-
1000	400	BBN001771510160000.	-	-	-	BBN001771320160000.	-	-	-

LINGO REGALSYSTEM

DOPPELSEITIG - RAHMENRAVERSE - STELLFÜßE - FÜR ABDECKFACHBODEN

Lackierte und furnierte Lingo Regale haben das FSC Zertifikat.

H720 mm

Achismaß mm	FB Tiefe mm	Bestell-Nr. Freistehendes Regal	Melamin	Lackiert	Furniert	Bestell-Nr. Mittel Regal	Melamin	Lackiert	Furniert
500	250	BBN001245510160000.	-	-	-	BBN001245320160000.	-	-	-
500	300	BBN001265510160000.	-	-	-	BBN001265320160000.	-	-	-
500	400	BBN001285510160000.	-	-	-	BBN001285320160000.	-	-	-
750	250	BBN001247510160000.	-	-	-	BBN001247320160000.	-	-	-
750	300	BBN001267510160000.	-	-	-	BBN001267320160000.	-	-	-
750	400	BBN001287510160000.	-	-	-	BBN001287320160000.	-	-	-
900	250	BBN001249510160000.	-	-	-	BBN001249320160000.	-	-	-
900	300	BBN001269510160000.	-	-	-	BBN001269320160000.	-	-	-
900	400	BBN001289510160000.	-	-	-	BBN001289320160000.	-	-	-
1000	250	BBN001241510160000.	-	-	-	BBN001241320160000.	-	-	-
1000	300	BBN001261510160000.	-	-	-	BBN001261320160000.	-	-	-
1000	400	BBN001281510160000.	-	-	-	BBN001281320160000.	-	-	-

H920 mm

Achismaß mm	FB Tiefe mm	Bestell-Nr. Freistehendes Regal	Melamin	Lackiert	Furniert	Bestell-Nr. Mittel Regal	Melamin	Lackiert	Furniert
500	250	BBN001345510160000.	-	-	-	BBN001345320160000.	-	-	-
500	300	BBN001365510160000.	-	-	-	BBN001365320160000.	-	-	-
500	400	BBN001385510160000.	-	-	-	BBN001385320160000.	-	-	-
750	250	BBN001347510160000.	-	-	-	BBN001347320160000.	-	-	-
750	300	BBN001367510160000.	-	-	-	BBN001367320160000.	-	-	-
750	400	BBN001387510160000.	-	-	-	BBN001387320160000.	-	-	-
900	250	BBN001349510160000.	-	-	-	BBN001349320160000.	-	-	-
900	300	BBN001369510160000.	-	-	-	BBN001369320160000.	-	-	-
900	400	BBN001389510160000.	-	-	-	BBN001389320160000.	-	-	-
1000	250	BBN001341510160000.	-	-	-	BBN001341320160000.	-	-	-
1000	300	BBN001361510160000.	-	-	-	BBN001361320160000.	-	-	-
1000	400	BBN001381510160000.	-	-	-	BBN001381320160000.	-	-	-

H1220 mm

Achismaß mm	FB Tiefe mm	Bestell-Nr. Freistehendes Regal	Melamin	Lackiert	Furniert	Bestell-Nr. Mittel Regal	Melamin	Lackiert	Furniert
500	250	BBN001445510160000.	-	-	-	BBN001445320160000.	-	-	-
500	300	BBN001465510160000.	-	-	-	BBN001465320160000.	-	-	-
500	400	BBN001485510160000.	-	-	-	BBN001485320160000.	-	-	-
750	250	BBN001447510160000.	-	-	-	BBN001447320160000.	-	-	-
750	300	BBN001467510160000.	-	-	-	BBN001467320160000.	-	-	-
750	400	BBN001487510160000.	-	-	-	BBN001487320160000.	-	-	-
900	250	BBN001449510160000.	-	-	-	BBN001449320160000.	-	-	-
900	300	BBN001469510160000.	-	-	-	BBN001469320160000.	-	-	-
900	400	BBN001489510160000.	-	-	-	BBN001489320160000.	-	-	-
1000	250	BBN001441510160000.	-	-	-	BBN001441320160000.	-	-	-
1000	300	BBN001461510160000.	-	-	-	BBN001461320160000.	-	-	-
1000	400	BBN001481510160000.	-	-	-	BBN001481320160000.	-	-	-

LINGO REGALSYSTEM

DOPPELSEITIG - RAHMENTRVERSE - STELLFÜßE - FÜR ABDECKFACHBODEN

Lackierte und furnierte Lingo Regale haben das FSC Zertifikat.

H1520 mm

Achsmaß mm	FB Tiefe mm	Bestell-Nr. Freistehendes Regal	Melamin	Lackiert	Furniert	Bestell-Nr. Mittel Regal	Melamin	Lackiert	Furniert
500	250	BBN001545510160000.	-	-	-	BBN001545320160000.	-	-	-
500	300	BBN001565510160000.	-	-	-	BBN001565320160000.	-	-	-
500	400	BBN001585510160000.	-	-	-	BBN001585320160000.	-	-	-
750	250	BBN001547510160000.	-	-	-	BBN001547320160000.	-	-	-
750	300	BBN001567510160000.	-	-	-	BBN001567320160000.	-	-	-
750	400	BBN001587510160000.	-	-	-	BBN001587320160000.	-	-	-
900	250	BBN001549510160000.	-	-	-	BBN001549320160000.	-	-	-
900	300	BBN001569510160000.	-	-	-	BBN001569320160000.	-	-	-
900	400	BBN001589510160000.	-	-	-	BBN001589320160000.	-	-	-
1000	250	BBN001541510160000.	-	-	-	BBN001541320160000.	-	-	-
1000	300	BBN001561510160000.	-	-	-	BBN001561320160000.	-	-	-
1000	400	BBN001581510160000.	-	-	-	BBN001581320160000.	-	-	-

H1820 mm

Achsmaß mm	FB Tiefe mm	Bestell-Nr. Freistehendes Regal	Melamin	Lackiert	Furniert	Bestell-Nr. Mittel Regal	Melamin	Lackiert	Furniert
500	250	BBN001645510160000.	-	-	-	BBN001645320160000.	-	-	-
500	300	BBN001665510160000.	-	-	-	BBN001665320160000.	-	-	-
500	400	BBN001685510160000.	-	-	-	BBN001685320160000.	-	-	-
750	250	BBN001647510160000.	-	-	-	BBN001647320160000.	-	-	-
750	300	BBN001667510160000.	-	-	-	BBN001667320160000.	-	-	-
750	400	BBN001687510160000.	-	-	-	BBN001687320160000.	-	-	-
900	250	BBN001649510160000.	-	-	-	BBN001649320160000.	-	-	-
900	300	BBN001669510160000.	-	-	-	BBN001669320160000.	-	-	-
900	400	BBN001689510160000.	-	-	-	BBN001689320160000.	-	-	-
1000	250	BBN001641510160000.	-	-	-	BBN001641320160000.	-	-	-
1000	300	BBN001661510160000.	-	-	-	BBN001661320160000.	-	-	-
1000	400	BBN001681510160000.	-	-	-	BBN001681320160000.	-	-	-

H2120 mm

Achsmaß mm	FB Tiefe mm	Bestell-Nr. Freistehendes Regal	Melamin	Lackiert	Furniert	Bestell-Nr. Mittel Regal	Melamin	Lackiert	Furniert
500	250	BBN001745510160000.	-	-	-	BBN001745320160000.	-	-	-
500	300	BBN001765510160000.	-	-	-	BBN001765320160000.	-	-	-
500	400	BBN001785510160000.	-	-	-	BBN001785320160000.	-	-	-
750	250	BBN001747510160000.	-	-	-	BBN001747320160000.	-	-	-
750	300	BBN001767510160000.	-	-	-	BBN001767320160000.	-	-	-
750	400	BBN001787510160000.	-	-	-	BBN001787320160000.	-	-	-
900	250	BBN001749510160000.	-	-	-	BBN001749320160000.	-	-	-
900	300	BBN001769510160000.	-	-	-	BBN001769320160000.	-	-	-
900	400	BBN001789510160000.	-	-	-	BBN001789320160000.	-	-	-
1000	250	BBN001741510160000.	-	-	-	BBN001741320160000.	-	-	-
1000	300	BBN001761510160000.	-	-	-	BBN001761320160000.	-	-	-
1000	400	BBN001781510160000.	-	-	-	BBN001781320160000.	-	-	-

LINGO REGALSYSTEM

BBN001 - HOCH RÜCKWAND - STELLFÜßE - FÜR ABDECKFACHBODEN



LINGO REGALSYSTEM

BBN001 - HOCH RÜCKWAND - STELLFÜßE - FÜR ABDECKFACHBODEN

Regalsystem mit Holzseiten und hoch Holzrückwand.

Zur Verwendung mit ST1 Standardtiefe, ST1 doppelseitig, ST2, ST3 und WT1 Standardtiefe Abdeckfachboden.

Freistehende Sektion beinhaltet 2 Seitenwände und 1 Holzrückwand.

Mittlere Sektion beinhaltet 1 Zwischenseite und 1 Holzrückwand.

- Preis basiert auf Metallpreisgruppe 1 und Holzpreisgruppe A (siehe Designauswahl Seiten 6-9).

- Für Fachböden siehe Seite 128.

- Für Funktionen siehe Seite 168.

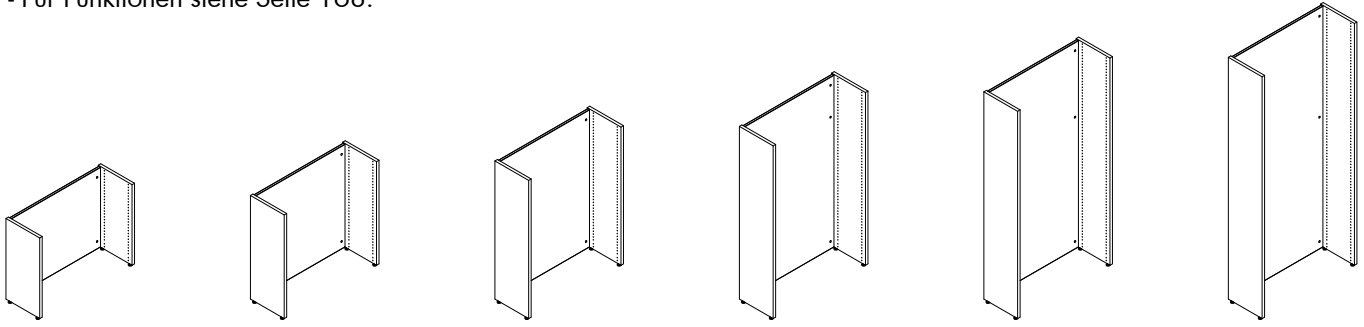

Einseitige freistehende Sektion - H720/920/1220/1520/1820/2120 mm

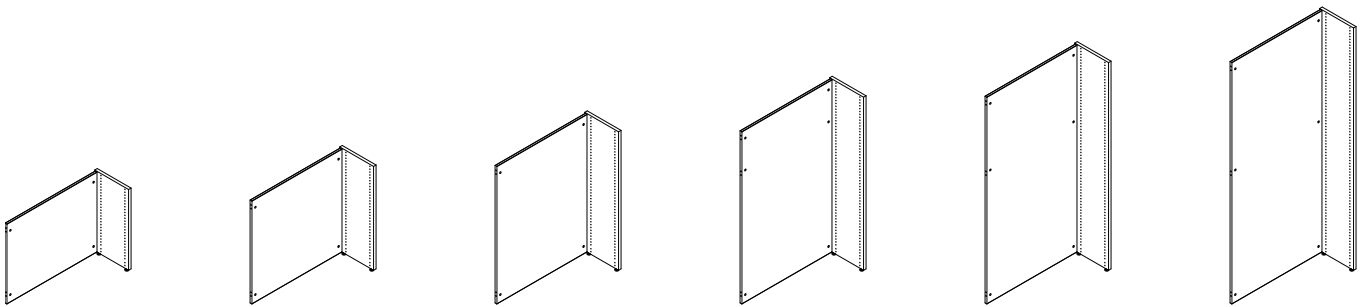

Einseitige mittlere Sektion - H720/920/1220/1520/1820/2120 mm

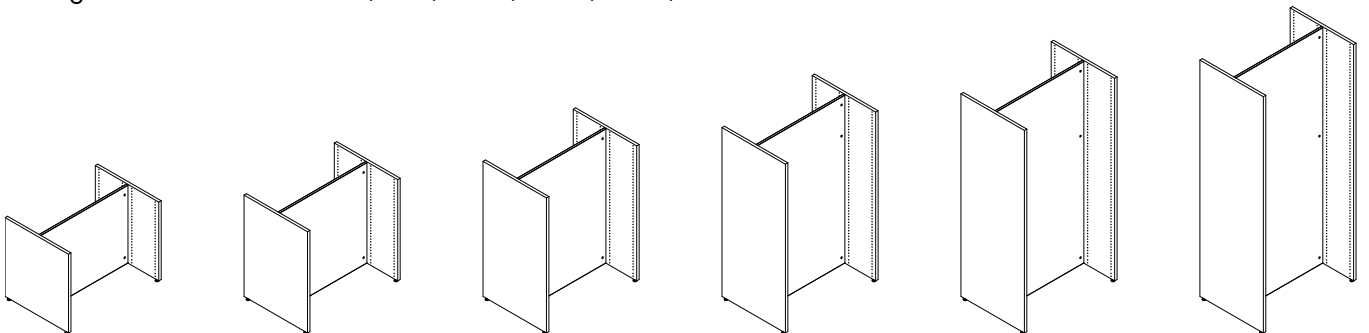

Doppelseitige freistehende Sektion - H720/920/1220/1520/1820/2120 mm

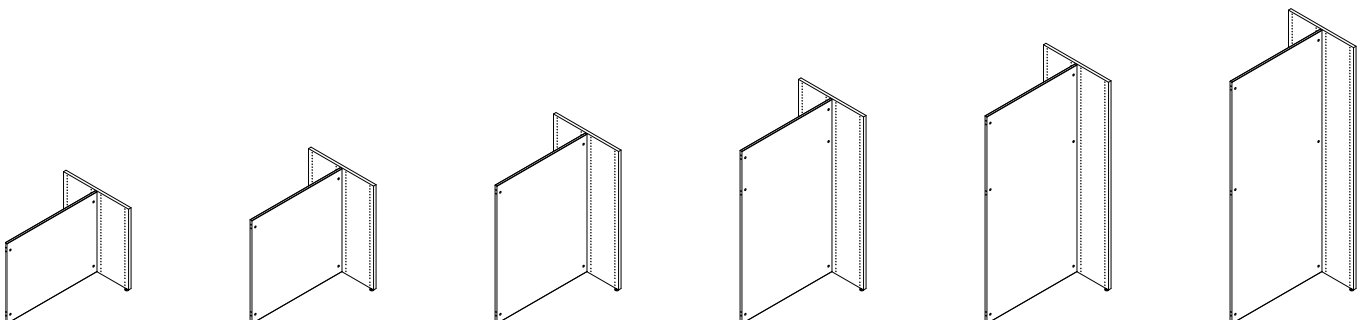

Doppelseitige mittlere Sektion - H720/920/1220/1520/1820/2120 mm

LINGO REGALSYSTEM

EINSEITIG - HOCH RÜCKWAND - STELLFÜßE - FÜR ABDECKFACHBODEN

Lackierte und furnierte Lingo Regale haben das FSC Zertifikat.

H720 mm

Achismaß mm	FB Tiefe mm	Bestell-Nr. Freistehendes Regal	Melamin	Lackiert	Furniert	Bestell-Nr. Mittel Regal	Melamin	Lackiert	Furniert
500	250	BBN001235510120000.	-	-	-	BBN001235320120000.	-	-	-
500	300	BBN001255510120000.	-	-	-	BBN001255320120000.	-	-	-
500	400	BBN001275510120000.	-	-	-	BBN001275320120000.	-	-	-
750	250	BBN001237510120000.	-	-	-	BBN001237320120000.	-	-	-
750	300	BBN001257510120000.	-	-	-	BBN001257320120000.	-	-	-
750	400	BBN001277510120000.	-	-	-	BBN001277320120000.	-	-	-
900	250	BBN001239510120000.	-	-	-	BBN001239320120000.	-	-	-
900	300	BBN001259510120000.	-	-	-	BBN001259320120000.	-	-	-
900	400	BBN001279510120000.	-	-	-	BBN001279320120000.	-	-	-
1000	250	BBN001231510120000.	-	-	-	BBN001231320120000.	-	-	-
1000	300	BBN001251510120000.	-	-	-	BBN001251320120000.	-	-	-
1000	400	BBN001271510120000.	-	-	-	BBN001271320120000.	-	-	-

H920 mm

Achismaß mm	FB Tiefe mm	Bestell-Nr. Freistehendes Regal	Melamin	Lackiert	Furniert	Bestell-Nr. Mittel Regal	Melamin	Lackiert	Furniert
500	250	BBN001335510120000.	-	-	-	BBN001335320120000.	-	-	-
500	300	BBN001355510120000.	-	-	-	BBN001355320120000.	-	-	-
500	400	BBN001375510120000.	-	-	-	BBN001375320120000.	-	-	-
750	250	BBN001337510120000.	-	-	-	BBN001337320120000.	-	-	-
750	300	BBN001357510120000.	-	-	-	BBN001357320120000.	-	-	-
750	400	BBN001377510120000.	-	-	-	BBN001377320120000.	-	-	-
900	250	BBN001339510120000.	-	-	-	BBN001339320120000.	-	-	-
900	300	BBN001359510120000.	-	-	-	BBN001359320120000.	-	-	-
900	400	BBN001379510120000.	-	-	-	BBN001379320120000.	-	-	-
1000	250	BBN001331510120000.	-	-	-	BBN001331320120000.	-	-	-
1000	300	BBN001351510120000.	-	-	-	BBN001351320120000.	-	-	-
1000	400	BBN001371510120000.	-	-	-	BBN001371320120000.	-	-	-

H1220 mm

Achismaß mm	FB Tiefe mm	Bestell-Nr. Freistehendes Regal	Melamin	Lackiert	Furniert	Bestell-Nr. Mittel Regal	Melamin	Lackiert	Furniert
500	250	BBN001435510120000.	-	-	-	BBN001435320120000.	-	-	-
500	300	BBN001455510120000.	-	-	-	BBN001455320120000.	-	-	-
500	400	BBN001475510120000.	-	-	-	BBN001475320120000.	-	-	-
750	250	BBN001437510120000.	-	-	-	BBN001437320120000.	-	-	-
750	300	BBN001457510120000.	-	-	-	BBN001457320120000.	-	-	-
750	400	BBN001477510120000.	-	-	-	BBN001477320120000.	-	-	-
900	250	BBN001439510120000.	-	-	-	BBN001439320120000.	-	-	-
900	300	BBN001459510120000.	-	-	-	BBN001459320120000.	-	-	-
900	400	BBN001479510120000.	-	-	-	BBN001479320120000.	-	-	-
1000	250	BBN001431510120000.	-	-	-	BBN001431320120000.	-	-	-
1000	300	BBN001451510120000.	-	-	-	BBN001451320120000.	-	-	-
1000	400	BBN001471510120000.	-	-	-	BBN001471320120000.	-	-	-

LINGO REGALSYSTEM

EINSEITIG - HOCH RÜCKWAND - STELLFÜßE - FÜR ABDECKFACHBODEN

Lackierte und furnierte Lingo Regale haben das FSC Zertifikat.

H1520 mm

Achsmaß mm	FB Tiefe mm	Bestell-Nr. Freistehendes Regal	Melamin	Lackiert	Furniert	Bestell-Nr. Mittel Regal	Melamin	Lackiert	Furniert
500	250	BBN001535510120000.	-	-	-	BBN001535320120000.	-	-	-
500	300	BBN001555510120000.	-	-	-	BBN001555320120000.	-	-	-
500	400	BBN001575510120000.	-	-	-	BBN001575320120000.	-	-	-
750	250	BBN001537510120000.	-	-	-	BBN001537320120000.	-	-	-
750	300	BBN001557510120000.	-	-	-	BBN001557320120000.	-	-	-
750	400	BBN001577510120000.	-	-	-	BBN001577320120000.	-	-	-
900	250	BBN001539510120000.	-	-	-	BBN001539320120000.	-	-	-
900	300	BBN001559510120000.	-	-	-	BBN001559320120000.	-	-	-
900	400	BBN001579510120000.	-	-	-	BBN001579320120000.	-	-	-
1000	250	BBN001531510120000.	-	-	-	BBN001531320120000.	-	-	-
1000	300	BBN001551510120000.	-	-	-	BBN001551320120000.	-	-	-
1000	400	BBN001571510120000.	-	-	-	BBN001571320120000.	-	-	-

H1820 mm

Achsmaß mm	FB Tiefe mm	Bestell-Nr. Freistehendes Regal	Melamin	Lackiert	Furniert	Bestell-Nr. Mittel Regal	Melamin	Lackiert	Furniert
500	250	BBN001635510120000.	-	-	-	BBN001635320120000.	-	-	-
500	300	BBN001655510120000.	-	-	-	BBN001655320120000.	-	-	-
500	400	BBN001675510120000.	-	-	-	BBN001675320120000.	-	-	-
750	250	BBN001637510120000.	-	-	-	BBN001637320120000.	-	-	-
750	300	BBN001657510120000.	-	-	-	BBN001657320120000.	-	-	-
750	400	BBN001677510120000.	-	-	-	BBN001677320120000.	-	-	-
900	250	BBN001639510120000.	-	-	-	BBN001639320120000.	-	-	-
900	300	BBN001659510120000.	-	-	-	BBN001659320120000.	-	-	-
900	400	BBN001679510120000.	-	-	-	BBN001679320120000.	-	-	-
1000	250	BBN001631510120000.	-	-	-	BBN001631320120000.	-	-	-
1000	300	BBN001651510120000.	-	-	-	BBN001651320120000.	-	-	-
1000	400	BBN001671510120000.	-	-	-	BBN001671320120000.	-	-	-

H2120 mm

Achsmaß mm	FB Tiefe mm	Bestell-Nr. Freistehendes Regal	Melamin	Lackiert	Furniert	Bestell-Nr. Mittel Regal	Melamin	Lackiert	Furniert
500	250	BBN001735510120000.	-	-	-	BBN001735320120000.	-	-	-
500	300	BBN001755510120000.	-	-	-	BBN001755320120000.	-	-	-
500	400	BBN001775510120000.	-	-	-	BBN001775320120000.	-	-	-
750	250	BBN001737510120000.	-	-	-	BBN001737320120000.	-	-	-
750	300	BBN001757510120000.	-	-	-	BBN001757320120000.	-	-	-
750	400	BBN001777510120000.	-	-	-	BBN001777320120000.	-	-	-
900	250	BBN001739510120000.	-	-	-	BBN001739320120000.	-	-	-
900	300	BBN001759510120000.	-	-	-	BBN001759320120000.	-	-	-
900	400	BBN001779510120000.	-	-	-	BBN001779320120000.	-	-	-
1000	250	BBN001731510120000.	-	-	-	BBN001731320120000.	-	-	-
1000	300	BBN001751510120000.	-	-	-	BBN001751320120000.	-	-	-
1000	400	BBN001771510120000.	-	-	-	BBN001771320120000.	-	-	-

LINGO REGALSYSTEM

DOPPELSEITIG - HOCH RÜCKWAND - STELLFÜßE - FÜR ABDECKFACHBODEN

Lackierte und furnierte Lingo Regale haben das FSC Zertifikat.

H720 mm

Achismaß mm	FB Tiefe mm	Bestell-Nr. Freistehendes Regal	Melamin	Lackiert	Furniert	Bestell-Nr. Mittel Regal	Melamin	Lackiert	Furniert
500	250	BBN001245510120000.	-	-	-	BBN001245320120000.	-	-	-
500	300	BBN001265510120000.	-	-	-	BBN001265320120000.	-	-	-
500	400	BBN001285510120000.	-	-	-	BBN001285320120000.	-	-	-
750	250	BBN001247510120000.	-	-	-	BBN001247320120000.	-	-	-
750	300	BBN001267510120000.	-	-	-	BBN001267320120000.	-	-	-
750	400	BBN001287510120000.	-	-	-	BBN001287320120000.	-	-	-
900	250	BBN001249510120000.	-	-	-	BBN001249320120000.	-	-	-
900	300	BBN001269510120000.	-	-	-	BBN001269320120000.	-	-	-
900	400	BBN001289510120000.	-	-	-	BBN001289320120000.	-	-	-
1000	250	BBN001241510120000.	-	-	-	BBN001241320120000.	-	-	-
1000	300	BBN001261510120000.	-	-	-	BBN001261320120000.	-	-	-
1000	400	BBN001281510120000.	-	-	-	BBN001281320120000.	-	-	-

H920 mm

Achismaß mm	FB Tiefe mm	Bestell-Nr. Freistehendes Regal	Melamin	Lackiert	Furniert	Bestell-Nr. Mittel Regal	Melamin	Lackiert	Furniert
500	250	BBN001345510120000.	-	-	-	BBN001345320120000.	-	-	-
500	300	BBN001365510120000.	-	-	-	BBN001365320120000.	-	-	-
500	400	BBN001385510120000.	-	-	-	BBN001385320120000.	-	-	-
750	250	BBN001347510120000.	-	-	-	BBN001347320120000.	-	-	-
750	300	BBN001367510120000.	-	-	-	BBN001367320120000.	-	-	-
750	400	BBN001387510120000.	-	-	-	BBN001387320120000.	-	-	-
900	250	BBN001349510120000.	-	-	-	BBN001349320120000.	-	-	-
900	300	BBN001369510120000.	-	-	-	BBN001369320120000.	-	-	-
900	400	BBN001389510120000.	-	-	-	BBN001389320120000.	-	-	-
1000	250	BBN001341510120000.	-	-	-	BBN001341320120000.	-	-	-
1000	300	BBN001361510120000.	-	-	-	BBN001361320120000.	-	-	-
1000	400	BBN001381510120000.	-	-	-	BBN001381320120000.	-	-	-

H1220 mm

Achismaß mm	FB Tiefe mm	Bestell-Nr. Freistehendes Regal	Melamin	Lackiert	Furniert	Bestell-Nr. Mittel Regal	Melamin	Lackiert	Furniert
500	250	BBN001445510120000.	-	-	-	BBN001445320120000.	-	-	-
500	300	BBN001465510120000.	-	-	-	BBN001465320120000.	-	-	-
500	400	BBN001485510120000.	-	-	-	BBN001485320120000.	-	-	-
750	250	BBN001447510120000.	-	-	-	BBN001447320120000.	-	-	-
750	300	BBN001467510120000.	-	-	-	BBN001467320120000.	-	-	-
750	400	BBN001487510120000.	-	-	-	BBN001487320120000.	-	-	-
900	250	BBN001449510120000.	-	-	-	BBN001449320120000.	-	-	-
900	300	BBN001469510120000.	-	-	-	BBN001469320120000.	-	-	-
900	400	BBN001489510120000.	-	-	-	BBN001489320120000.	-	-	-
1000	250	BBN001441510120000.	-	-	-	BBN001441320120000.	-	-	-
1000	300	BBN001461510120000.	-	-	-	BBN001461320120000.	-	-	-
1000	400	BBN001481510120000.	-	-	-	BBN001481320120000.	-	-	-

LINGO REGALSYSTEM

DOPPELSEITIG - HOCH RÜCKWAND - STELLFÜßE - FÜR ABDECKFACHBODEN

Lackierte und furnierte Lingo Regale haben das FSC Zertifikat.

H1520 mm

Achsmaß mm	FB Tiefe mm	Bestell-Nr. Freistehendes Regal	Melamin	Lackiert	Furniert	Bestell-Nr. Mittel Regal	Melamin	Lackiert	Furniert
500	250	BBN001545510120000.	-	-	-	BBN001545320120000.	-	-	-
500	300	BBN001565510120000.	-	-	-	BBN001565320120000.	-	-	-
500	400	BBN001585510120000.	-	-	-	BBN001585320120000.	-	-	-
750	250	BBN001547510120000.	-	-	-	BBN001547320120000.	-	-	-
750	300	BBN001567510120000.	-	-	-	BBN001567320120000.	-	-	-
750	400	BBN001587510120000.	-	-	-	BBN001587320120000.	-	-	-
900	250	BBN001549510120000.	-	-	-	BBN001549320120000.	-	-	-
900	300	BBN001569510120000.	-	-	-	BBN001569320120000.	-	-	-
900	400	BBN001589510120000.	-	-	-	BBN001589320120000.	-	-	-
1000	250	BBN001541510120000.	-	-	-	BBN001541320120000.	-	-	-
1000	300	BBN001561510120000.	-	-	-	BBN001561320120000.	-	-	-
1000	400	BBN001581510120000.	-	-	-	BBN001581320120000.	-	-	-

H1820 mm

Achsmaß mm	FB Tiefe mm	Bestell-Nr. Freistehendes Regal	Melamin	Lackiert	Furniert	Bestell-Nr. Mittel Regal	Melamin	Lackiert	Furniert
500	250	BBN001645510120000.	-	-	-	BBN001645320120000.	-	-	-
500	300	BBN001665510120000.	-	-	-	BBN001665320120000.	-	-	-
500	400	BBN001685510120000.	-	-	-	BBN001685320120000.	-	-	-
750	250	BBN001647510120000.	-	-	-	BBN001647320120000.	-	-	-
750	300	BBN001667510120000.	-	-	-	BBN001667320120000.	-	-	-
750	400	BBN001687510120000.	-	-	-	BBN001687320120000.	-	-	-
900	250	BBN001649510120000.	-	-	-	BBN001649320120000.	-	-	-
900	300	BBN001669510120000.	-	-	-	BBN001669320120000.	-	-	-
900	400	BBN001689510120000.	-	-	-	BBN001689320120000.	-	-	-
1000	250	BBN001641510120000.	-	-	-	BBN001641320120000.	-	-	-
1000	300	BBN001661510120000.	-	-	-	BBN001661320120000.	-	-	-
1000	400	BBN001681510120000.	-	-	-	BBN001681320120000.	-	-	-

H2120 mm

Achsmaß mm	FB Tiefe mm	Bestell-Nr. Freistehendes Regal	Melamin	Lackiert	Furniert	Bestell-Nr. Mittel Regal	Melamin	Lackiert	Furniert
500	250	BBN001745510120000.	-	-	-	BBN001745320120000.	-	-	-
500	300	BBN001765510120000.	-	-	-	BBN001765320120000.	-	-	-
500	400	BBN001785510120000.	-	-	-	BBN001785320120000.	-	-	-
750	250	BBN001747510120000.	-	-	-	BBN001747320120000.	-	-	-
750	300	BBN001767510120000.	-	-	-	BBN001767320120000.	-	-	-
750	400	BBN001787510120000.	-	-	-	BBN001787320120000.	-	-	-
900	250	BBN001749510120000.	-	-	-	BBN001749320120000.	-	-	-
900	300	BBN001769510120000.	-	-	-	BBN001769320120000.	-	-	-
900	400	BBN001789510120000.	-	-	-	BBN001789320120000.	-	-	-
1000	250	BBN001741510120000.	-	-	-	BBN001741320120000.	-	-	-
1000	300	BBN001761510120000.	-	-	-	BBN001761320120000.	-	-	-
1000	400	BBN001781510120000.	-	-	-	BBN001781320120000.	-	-	-

LINGO REGALSYSTEM

BBN001 - NIEDRIG RÜCKWAND - STELLFÜßE - FÜR ABDECKFACHBODEN



LINGO REGALSYSTEM

BBN001 - NIEDRIG RÜCKWAND - STELLFÜßE - FÜR ABDECKFACHBODEN

Regalsystem mit Holzseiten und niedrig Holzrückwand.

Zur Verwendung mit ST1 einseitig Volltiefe, WT1 einseitig Volltiefe und WT1 doppelseitig Abdeckboden.

Freistehende Sektion beinhaltet 2 Seitenwände und 1 Holzrückwand.

Mittlere Sektion beinhaltet 1 Zwischenseite und 1 Holzrückwand.

- Preis basiert auf Metallpreisgruppe 1 und Holzpreisgruppe A (siehe Designauswahl Seiten 6-9).

- Für Fachböden siehe Seite 128.

- Für Funktionen siehe Seite 168.

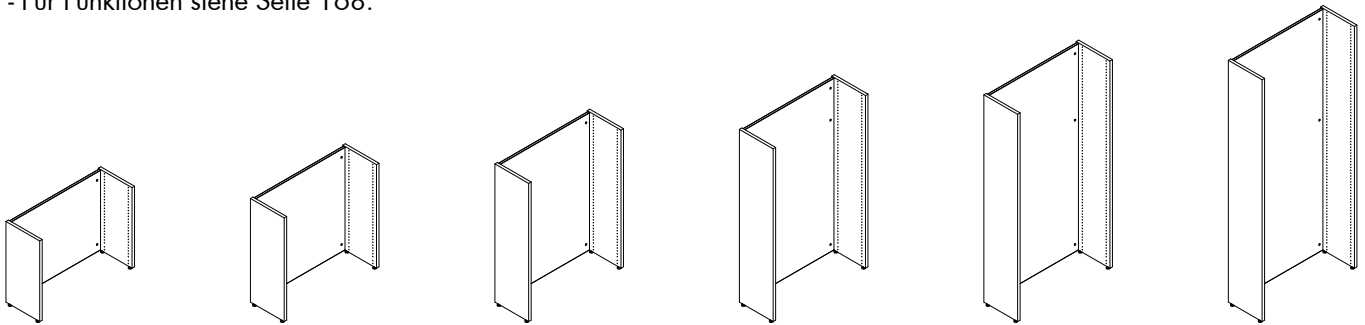

Einseitige freistehende Sektion - H720/920/1220/1520/1820/2120 mm

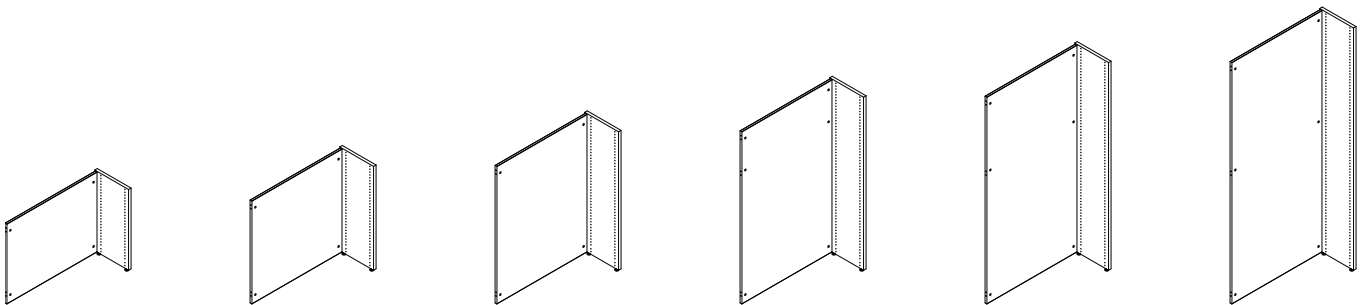

Einseitige mittlere Sektion - H720/920/1220/1520/1820/2120 mm

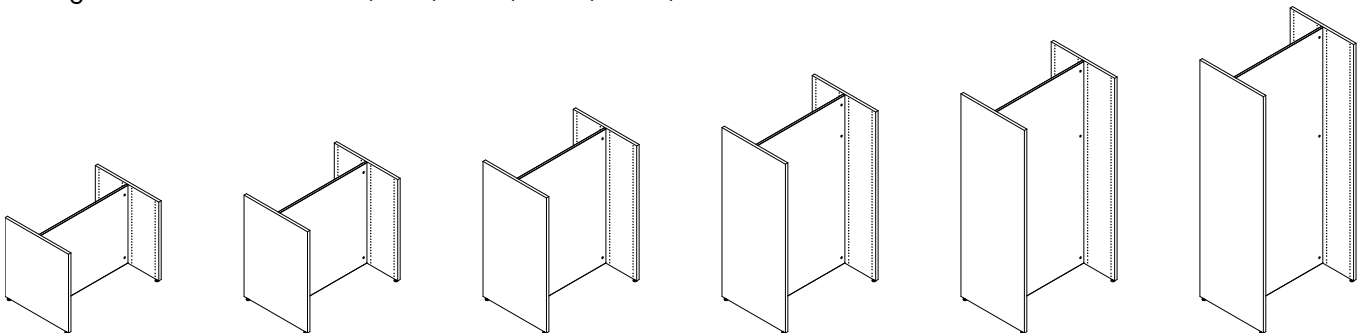

Doppelseitige freistehende Sektion - H720/920/1220/1520/1820/2120 mm

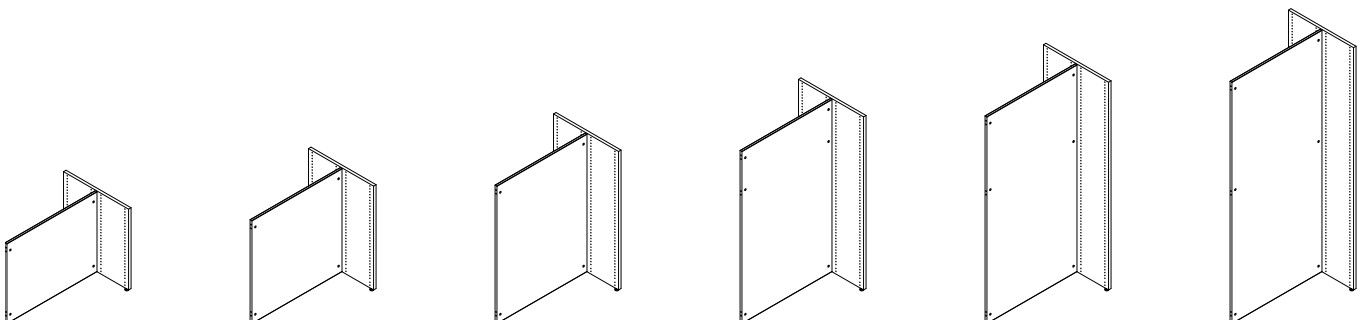

Doppelseitige mittlere Sektion - H720/920/1220/1520/1820/2120 mm

LINGO REGALSYSTEM

EINSEITIG - RÜCKWAND - STELLFÜßE - FÜR ABDECKFACHBODEN

Lackierte und furnierte Lingo Regale haben das FSC Zertifikat.

H720 mm

Achismaß mm	FB Tiefe mm	Bestell-Nr. Freistehendes Regal	Melamin	Lackiert	Furniert	Bestell-Nr. Mittel Regal	Melamin	Lackiert	Furniert
500	250	BBN001235510110000.	-	-	-	BBN001235320110000.	-	-	-
500	300	BBN001255510110000.	-	-	-	BBN001255320110000.	-	-	-
500	400	BBN001275510110000.	-	-	-	BBN001275320110000.	-	-	-
750	250	BBN001237510110000.	-	-	-	BBN001237320110000.	-	-	-
750	300	BBN001257510110000.	-	-	-	BBN001257320110000.	-	-	-
750	400	BBN001277510110000.	-	-	-	BBN001277320110000.	-	-	-
900	250	BBN001239510110000.	-	-	-	BBN001239320110000.	-	-	-
900	300	BBN001259510110000.	-	-	-	BBN001259320110000.	-	-	-
900	400	BBN001279510110000.	-	-	-	BBN001279320110000.	-	-	-
1000	250	BBN001231510110000.	-	-	-	BBN001231320110000.	-	-	-
1000	300	BBN001251510110000.	-	-	-	BBN001251320110000.	-	-	-
1000	400	BBN001271510110000.	-	-	-	BBN001271320110000.	-	-	-

H920 mm

Achismaß mm	FB Tiefe mm	Bestell-Nr. Freistehendes Regal	Melamin	Lackiert	Furniert	Bestell-Nr. Mittel Regal	Melamin	Lackiert	Furniert
500	250	BBN001335510110000.	-	-	-	BBN001335320110000.	-	-	-
500	300	BBN001355510110000.	-	-	-	BBN001355320110000.	-	-	-
500	400	BBN001375510110000.	-	-	-	BBN001375320110000.	-	-	-
750	250	BBN001337510110000.	-	-	-	BBN001337320110000.	-	-	-
750	300	BBN001357510110000.	-	-	-	BBN001357320110000.	-	-	-
750	400	BBN001377510110000.	-	-	-	BBN001377320110000.	-	-	-
900	250	BBN001339510110000.	-	-	-	BBN001339320110000.	-	-	-
900	300	BBN001359510110000.	-	-	-	BBN001359320110000.	-	-	-
900	400	BBN001379510110000.	-	-	-	BBN001379320110000.	-	-	-
1000	250	BBN001331510110000.	-	-	-	BBN001331320110000.	-	-	-
1000	300	BBN001351510110000.	-	-	-	BBN001351320110000.	-	-	-
1000	400	BBN001371510110000.	-	-	-	BBN001371320110000.	-	-	-

H1220 mm

Achismaß mm	FB Tiefe mm	Bestell-Nr. Freistehendes Regal	Melamin	Lackiert	Furniert	Bestell-Nr. Mittel Regal	Melamin	Lackiert	Furniert
500	250	BBN001435510110000.	-	-	-	BBN001435320110000.	-	-	-
500	300	BBN001455510110000.	-	-	-	BBN001455320110000.	-	-	-
500	400	BBN001475510110000.	-	-	-	BBN001475320110000.	-	-	-
750	250	BBN001437510110000.	-	-	-	BBN001437320110000.	-	-	-
750	300	BBN001457510110000.	-	-	-	BBN001457320110000.	-	-	-
750	400	BBN001477510110000.	-	-	-	BBN001477320110000.	-	-	-
900	250	BBN001439510110000.	-	-	-	BBN001439320110000.	-	-	-
900	300	BBN001459510110000.	-	-	-	BBN001459320110000.	-	-	-
900	400	BBN001479510110000.	-	-	-	BBN001479320110000.	-	-	-
1000	250	BBN001431510110000.	-	-	-	BBN001431320110000.	-	-	-
1000	300	BBN001451510110000.	-	-	-	BBN001451320110000.	-	-	-
1000	400	BBN001471510110000.	-	-	-	BBN001471320110000.	-	-	-

LINGO REGALSYSTEM

EINSEITIG - RÜCKWAND - STELLFÜßE - FÜR ABDECKFACHBODEN

Lackierte und furnierte Lingo Regale haben das FSC Zertifikat.

H1520 mm

Achsmaß mm	FB Tiefe mm	Bestell-Nr. Freistehendes Regal	Melamin	Lackiert	Furniert	Bestell-Nr. Mittel Regal	Melamin	Lackiert	Furniert
500	250	BBN001535510110000.	-	-	-	BBN001535320110000.	-	-	-
500	300	BBN001555510110000.	-	-	-	BBN001555320110000.	-	-	-
500	400	BBN001575510110000.	-	-	-	BBN001575320110000.	-	-	-
750	250	BBN001537510110000.	-	-	-	BBN001537320110000.	-	-	-
750	300	BBN001557510110000.	-	-	-	BBN001557320110000.	-	-	-
750	400	BBN001577510110000.	-	-	-	BBN001577320110000.	-	-	-
900	250	BBN001539510110000.	-	-	-	BBN001539320110000.	-	-	-
900	300	BBN001559510110000.	-	-	-	BBN001559320110000.	-	-	-
900	400	BBN001579510110000.	-	-	-	BBN001579320110000.	-	-	-
1000	250	BBN001531510110000.	-	-	-	BBN001531320110000.	-	-	-
1000	300	BBN001551510110000.	-	-	-	BBN001551320110000.	-	-	-
1000	400	BBN001571510110000.	-	-	-	BBN001571320110000.	-	-	-

H1820 mm

Achsmaß mm	FB Tiefe mm	Bestell-Nr. Freistehendes Regal	Melamin	Lackiert	Furniert	Bestell-Nr. Mittel Regal	Melamin	Lackiert	Furniert
500	250	BBN001635510110000.	-	-	-	BBN001635320110000.	-	-	-
500	300	BBN001655510110000.	-	-	-	BBN001655320110000.	-	-	-
500	400	BBN001675510110000.	-	-	-	BBN001675320110000.	-	-	-
750	250	BBN001637510110000.	-	-	-	BBN001637320110000.	-	-	-
750	300	BBN001657510110000.	-	-	-	BBN001657320110000.	-	-	-
750	400	BBN001677510110000.	-	-	-	BBN001677320110000.	-	-	-
900	250	BBN001639510110000.	-	-	-	BBN001639320110000.	-	-	-
900	300	BBN001659510110000.	-	-	-	BBN001659320110000.	-	-	-
900	400	BBN001679510110000.	-	-	-	BBN001679320110000.	-	-	-
1000	250	BBN001631510110000.	-	-	-	BBN001631320110000.	-	-	-
1000	300	BBN001651510110000.	-	-	-	BBN001651320110000.	-	-	-
1000	400	BBN001671510110000.	-	-	-	BBN001671320110000.	-	-	-

H2120 mm

Achsmaß mm	FB Tiefe mm	Bestell-Nr. Freistehendes Regal	Melamin	Lackiert	Furniert	Bestell-Nr. Mittel Regal	Melamin	Lackiert	Furniert
500	250	BBN001735510110000.	-	-	-	BBN001735320110000.	-	-	-
500	300	BBN001755510110000.	-	-	-	BBN001755320110000.	-	-	-
500	400	BBN001775510110000.	-	-	-	BBN001775320110000.	-	-	-
750	250	BBN001737510110000.	-	-	-	BBN001737320110000.	-	-	-
750	300	BBN001757510110000.	-	-	-	BBN001757320110000.	-	-	-
750	400	BBN001777510110000.	-	-	-	BBN001777320110000.	-	-	-
900	250	BBN001739510110000.	-	-	-	BBN001739320110000.	-	-	-
900	300	BBN001759510110000.	-	-	-	BBN001759320110000.	-	-	-
900	400	BBN001779510110000.	-	-	-	BBN001779320110000.	-	-	-
1000	250	BBN001731510110000.	-	-	-	BBN001731320110000.	-	-	-
1000	300	BBN001751510110000.	-	-	-	BBN001751320110000.	-	-	-
1000	400	BBN001771510110000.	-	-	-	BBN001771320110000.	-	-	-

LINGO REGALSYSTEM

DOPPELSEITIG - RÜCKWAND - STELLFÜßE - FÜR ABDECKFACHBODEN

Lackierte und furnierte Lingo Regale haben das FSC Zertifikat.

H720 mm

Achismaß mm	FB Tiefe mm	Bestell-Nr. Freistehendes Regal	Melamin	Lackiert	Furniert	Bestell-Nr. Mittel Regal	Melamin	Lackiert	Furniert
500	250	BBN001245510110000.	-	-	-	BBN001245320110000.	-	-	-
500	300	BBN001265510110000.	-	-	-	BBN001265320110000.	-	-	-
500	400	BBN001285510110000.	-	-	-	BBN001285320110000.	-	-	-
750	250	BBN001247510110000.	-	-	-	BBN001247320110000.	-	-	-
750	300	BBN001267510110000.	-	-	-	BBN001267320110000.	-	-	-
750	400	BBN001287510110000.	-	-	-	BBN001287320110000.	-	-	-
900	250	BBN001249510110000.	-	-	-	BBN001249320110000.	-	-	-
900	300	BBN001269510110000.	-	-	-	BBN001269320110000.	-	-	-
900	400	BBN001289510110000.	-	-	-	BBN001289320110000.	-	-	-
1000	250	BBN001241510110000.	-	-	-	BBN001241320110000.	-	-	-
1000	300	BBN001261510110000.	-	-	-	BBN001261320110000.	-	-	-
1000	400	BBN001281510110000.	-	-	-	BBN001281320110000.	-	-	-

H920 mm

Achismaß mm	FB Tiefe mm	Bestell-Nr. Freistehendes Regal	Melamin	Lackiert	Furniert	Bestell-Nr. Mittel Regal	Melamin	Lackiert	Furniert
500	250	BBN001345510110000.	-	-	-	BBN001345320110000.	-	-	-
500	300	BBN001365510110000.	-	-	-	BBN001365320110000.	-	-	-
500	400	BBN001385510110000.	-	-	-	BBN001385320110000.	-	-	-
750	250	BBN001347510110000.	-	-	-	BBN001347320110000.	-	-	-
750	300	BBN001367510110000.	-	-	-	BBN001367320110000.	-	-	-
750	400	BBN001387510110000.	-	-	-	BBN001387320110000.	-	-	-
900	250	BBN001349510110000.	-	-	-	BBN001349320110000.	-	-	-
900	300	BBN001369510110000.	-	-	-	BBN001369320110000.	-	-	-
900	400	BBN001389510110000.	-	-	-	BBN001389320110000.	-	-	-
1000	250	BBN001341510110000.	-	-	-	BBN001341320110000.	-	-	-
1000	300	BBN001361510110000.	-	-	-	BBN001361320110000.	-	-	-
1000	400	BBN001381510110000.	-	-	-	BBN001381320110000.	-	-	-

H1220 mm

Achismaß mm	FB Tiefe mm	Bestell-Nr. Freistehendes Regal	Melamin	Lackiert	Furniert	Bestell-Nr. Mittel Regal	Melamin	Lackiert	Furniert
500	250	BBN001445510110000.	-	-	-	BBN001445320110000.	-	-	-
500	300	BBN001465510110000.	-	-	-	BBN001465320110000.	-	-	-
500	400	BBN001485510110000.	-	-	-	BBN001485320110000.	-	-	-
750	250	BBN001447510110000.	-	-	-	BBN001447320110000.	-	-	-
750	300	BBN001467510110000.	-	-	-	BBN001467320110000.	-	-	-
750	400	BBN001487510110000.	-	-	-	BBN001487320110000.	-	-	-
900	250	BBN001449510110000.	-	-	-	BBN001449320110000.	-	-	-
900	300	BBN001469510110000.	-	-	-	BBN001469320110000.	-	-	-
900	400	BBN001489510110000.	-	-	-	BBN001489320110000.	-	-	-
1000	250	BBN001441510110000.	-	-	-	BBN001441320110000.	-	-	-
1000	300	BBN001461510110000.	-	-	-	BBN001461320110000.	-	-	-
1000	400	BBN001481510110000.	-	-	-	BBN001481320110000.	-	-	-

LINGO REGALSYSTEM

DOPPELSEITIG - RÜCKWAND - STELLFÜßE - FÜR ABDECKFACHBODEN

Lackierte und furnierte Lingo Regale haben das FSC Zertifikat.

H1520 mm

Achsmaß mm	FB Tiefe mm	Bestell-Nr. Freistehendes Regal	Melamin	Lackiert	Furniert	Bestell-Nr. Mittel Regal	Melamin	Lackiert	Furniert
500	250	BBN001545510110000.	-	-	-	BBN001545320110000.	-	-	-
500	300	BBN001565510110000.	-	-	-	BBN001565320110000.	-	-	-
500	400	BBN001585510110000.	-	-	-	BBN001585320110000.	-	-	-
750	250	BBN001547510110000.	-	-	-	BBN001547320110000.	-	-	-
750	300	BBN001567510110000.	-	-	-	BBN001567320110000.	-	-	-
750	400	BBN001587510110000.	-	-	-	BBN001587320110000.	-	-	-
900	250	BBN001549510110000.	-	-	-	BBN001549320110000.	-	-	-
900	300	BBN001569510110000.	-	-	-	BBN001569320110000.	-	-	-
900	400	BBN001589510110000.	-	-	-	BBN001589320110000.	-	-	-
1000	250	BBN001541510110000.	-	-	-	BBN001541320110000.	-	-	-
1000	300	BBN001561510110000.	-	-	-	BBN001561320110000.	-	-	-
1000	400	BBN001581510110000.	-	-	-	BBN001581320110000.	-	-	-

H1820 mm

Achsmaß mm	FB Tiefe mm	Bestell-Nr. Freistehendes Regal	Melamin	Lackiert	Furniert	Bestell-Nr. Mittel Regal	Melamin	Lackiert	Furniert
500	250	BBN001645510110000.	-	-	-	BBN001645320110000.	-	-	-
500	300	BBN001665510110000.	-	-	-	BBN001665320110000.	-	-	-
500	400	BBN001685510110000.	-	-	-	BBN001685320110000.	-	-	-
750	250	BBN001647510110000.	-	-	-	BBN001647320110000.	-	-	-
750	300	BBN001667510110000.	-	-	-	BBN001667320110000.	-	-	-
750	400	BBN001687510110000.	-	-	-	BBN001687320110000.	-	-	-
900	250	BBN001649510110000.	-	-	-	BBN001649320110000.	-	-	-
900	300	BBN001669510110000.	-	-	-	BBN001669320110000.	-	-	-
900	400	BBN001689510110000.	-	-	-	BBN001689320110000.	-	-	-
1000	250	BBN001641510110000.	-	-	-	BBN001641320110000.	-	-	-
1000	300	BBN001661510110000.	-	-	-	BBN001661320110000.	-	-	-
1000	400	BBN001681510110000.	-	-	-	BBN001681320110000.	-	-	-

H2120 mm

Achsmaß mm	FB Tiefe mm	Bestell-Nr. Freistehendes Regal	Melamin	Lackiert	Furniert	Bestell-Nr. Mittel Regal	Melamin	Lackiert	Furniert
500	250	BBN001745510110000.	-	-	-	BBN001745320110000.	-	-	-
500	300	BBN001765510110000.	-	-	-	BBN001765320110000.	-	-	-
500	400	BBN001785510110000.	-	-	-	BBN001785320110000.	-	-	-
750	250	BBN001747510110000.	-	-	-	BBN001747320110000.	-	-	-
750	300	BBN001767510110000.	-	-	-	BBN001767320110000.	-	-	-
750	400	BBN001787510110000.	-	-	-	BBN001787320110000.	-	-	-
900	250	BBN001749510110000.	-	-	-	BBN001749320110000.	-	-	-
900	300	BBN001769510110000.	-	-	-	BBN001769320110000.	-	-	-
900	400	BBN001789510110000.	-	-	-	BBN001789320110000.	-	-	-
1000	250	BBN001741510110000.	-	-	-	BBN001741320110000.	-	-	-
1000	300	BBN001761510110000.	-	-	-	BBN001761320110000.	-	-	-
1000	400	BBN001781510110000.	-	-	-	BBN001781320110000.	-	-	-

LINGO REGALSYSTEM

BBN001 - DIAGONALTRAVERSE - STELLFÜßE - FÜR ABDECKFACHBODEN



LINGO REGALSYSTEM

BBN001 - DIAGONALTRAVERSE - STELLFÜßE - FÜR ABDECKFACHBODEN

Regalsystem mit Holzseiten und Diagonaltraverse. Zur Verwendung mit Abdeckboden. Freistehende Sektion beinhaltet 2 Seitenwände und 1 Diagonaltraverse. Mittlere Sektion beinhaltet 1 Zwischenseite und 1 Diagonaltraverse. 1 Zwischenfachboden muß mit den Holzseiten bei Höhen über H1220 mm verschraubt werden.

- Preis basiert auf Metallpreisgruppe 1 und Holzpreisgruppe A (siehe Designauswahl Seiten 6-9).
- Für Fachböden siehe Seite 128.
- Für Funktionen siehe Seite 168.

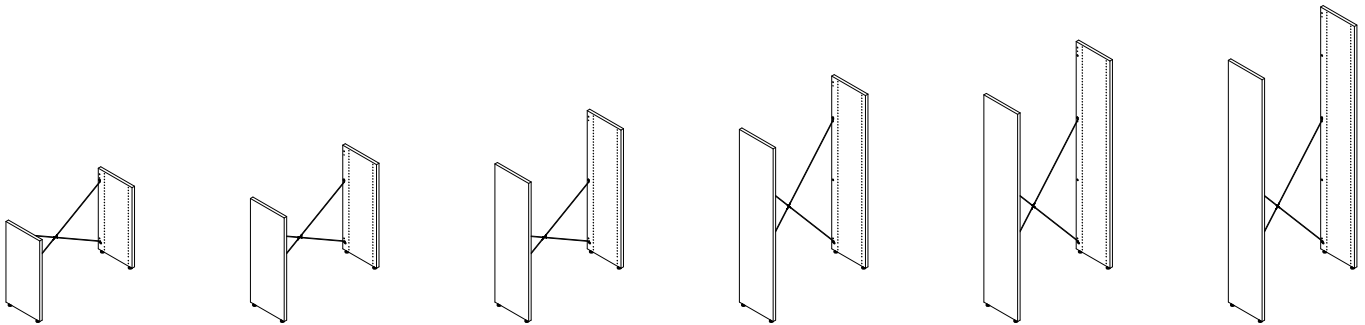

Einseitige freistehende Sektion - H720/920/1220/1520/1820/2120 mm

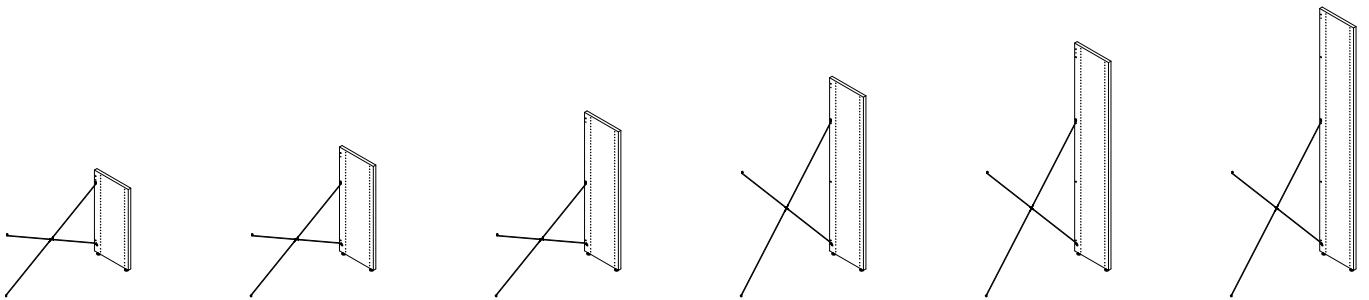

Einseitige mittlere Sektion - H720/920/1220/1520/1820/2120 mm

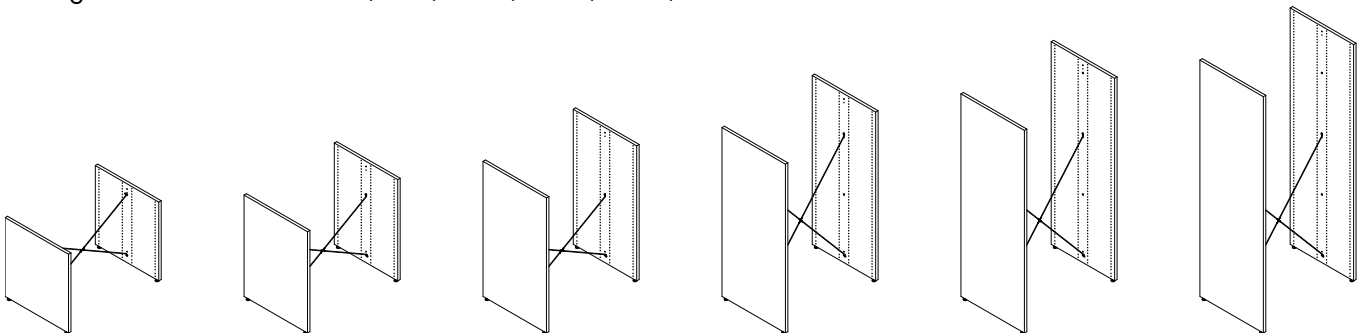

Doppelseitige freistehende Sektion - H720/920/1220/1520/1820/2120 mm

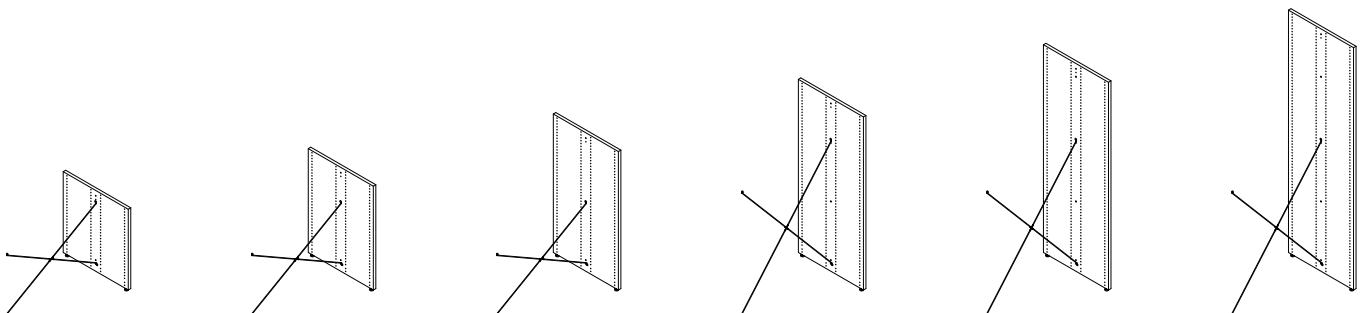

Doppelseitige mittlere Sektion - H720/920/1220/1520/1820/2120 mm

LINGO REGALSYSTEM

EINSEITIG - DIAGONALTRAVERSE - STELLFÜßE - FÜR ABDECKFACHBODEN

Lackierte und furnierte Lingo Regale haben das FSC Zertifikat.

H720 mm

Achismaß mm	FB Tiefe mm	Bestell-Nr. Freistehendes Regal	Melamin	Lackiert	Furniert	Bestell-Nr. Mittel Regal	Melamin	Lackiert	Furniert
500	250	BBN001235510190000.	-	-	-	BBN001235320190000.	-	-	-
500	300	BBN001255510190000.	-	-	-	BBN001255320190000.	-	-	-
500	400	BBN001275510190000.	-	-	-	BBN001275320190000.	-	-	-
750	250	BBN001237510190000.	-	-	-	BBN001237320190000.	-	-	-
750	300	BBN001257510190000.	-	-	-	BBN001257320190000.	-	-	-
750	400	BBN001277510190000.	-	-	-	BBN001277320190000.	-	-	-
900	250	BBN001239510190000.	-	-	-	BBN001239320190000.	-	-	-
900	300	BBN001259510190000.	-	-	-	BBN001259320190000.	-	-	-
900	400	BBN001279510190000.	-	-	-	BBN001279320190000.	-	-	-
1000	250	BBN001231510190000.	-	-	-	BBN001231320190000.	-	-	-
1000	300	BBN001251510190000.	-	-	-	BBN001251320190000.	-	-	-
1000	400	BBN001271510190000.	-	-	-	BBN001271320190000.	-	-	-

H920 mm

Achismaß mm	FB Tiefe mm	Bestell-Nr. Freistehendes Regal	Melamin	Lackiert	Furniert	Bestell-Nr. Mittel Regal	Melamin	Lackiert	Furniert
500	250	BBN001335510190000.	-	-	-	BBN001335320190000.	-	-	-
500	300	BBN001355510190000.	-	-	-	BBN001355320190000.	-	-	-
500	400	BBN001375510190000.	-	-	-	BBN001375320190000.	-	-	-
750	250	BBN001337510190000.	-	-	-	BBN001337320190000.	-	-	-
750	300	BBN001357510190000.	-	-	-	BBN001357320190000.	-	-	-
750	400	BBN001377510190000.	-	-	-	BBN001377320190000.	-	-	-
900	250	BBN001339510190000.	-	-	-	BBN001339320190000.	-	-	-
900	300	BBN001359510190000.	-	-	-	BBN001359320190000.	-	-	-
900	400	BBN001379510190000.	-	-	-	BBN001379320190000.	-	-	-
1000	250	BBN001331510190000.	-	-	-	BBN001331320190000.	-	-	-
1000	300	BBN001351510190000.	-	-	-	BBN001351320190000.	-	-	-
1000	400	BBN001371510190000.	-	-	-	BBN001371320190000.	-	-	-

H1220 mm

Achismaß mm	FB Tiefe mm	Bestell-Nr. Freistehendes Regal	Melamin	Lackiert	Furniert	Bestell-Nr. Mittel Regal	Melamin	Lackiert	Furniert
500	250	BBN001435510190000.	-	-	-	BBN001435320190000.	-	-	-
500	300	BBN001455510190000.	-	-	-	BBN001455320190000.	-	-	-
500	400	BBN001475510190000.	-	-	-	BBN001475320190000.	-	-	-
750	250	BBN001437510190000.	-	-	-	BBN001437320190000.	-	-	-
750	300	BBN001457510190000.	-	-	-	BBN001457320190000.	-	-	-
750	400	BBN001477510190000.	-	-	-	BBN001477320190000.	-	-	-
900	250	BBN001439510190000.	-	-	-	BBN001439320190000.	-	-	-
900	300	BBN001459510190000.	-	-	-	BBN001459320190000.	-	-	-
900	400	BBN001479510190000.	-	-	-	BBN001479320190000.	-	-	-
1000	250	BBN001431510190000.	-	-	-	BBN001431320190000.	-	-	-
1000	300	BBN001451510190000.	-	-	-	BBN001451320190000.	-	-	-
1000	400	BBN001471510190000.	-	-	-	BBN001471320190000.	-	-	-

LINGO REGALSYSTEM

EINSEITIG - DIAGONALTRAVERSE - STELLFÜßE - FÜR ABDECKFACHBODEN

Lackierte und furnierte Lingo Regale haben das FSC Zertifikat.

H1520 mm

Achsmaß mm	FB Tiefe mm	Bestell-Nr. Freistehendes Regal	Melamin	Lackiert	Furniert	Bestell-Nr. Mittel Regal	Melamin	Lackiert	Furniert
500	250	BBN001535510190000.	-	-	-	BBN001535320190000.	-	-	-
500	300	BBN001555510190000.	-	-	-	BBN001555320190000.	-	-	-
500	400	BBN001575510190000.	-	-	-	BBN001575320190000.	-	-	-
750	250	BBN001537510190000.	-	-	-	BBN001537320190000.	-	-	-
750	300	BBN001557510190000.	-	-	-	BBN001557320190000.	-	-	-
750	400	BBN001577510190000.	-	-	-	BBN001577320190000.	-	-	-
900	250	BBN001539510190000.	-	-	-	BBN001539320190000.	-	-	-
900	300	BBN001559510190000.	-	-	-	BBN001559320190000.	-	-	-
900	400	BBN001579510190000.	-	-	-	BBN001579320190000.	-	-	-
1000	250	BBN001531510190000.	-	-	-	BBN001531320190000.	-	-	-
1000	300	BBN001551510190000.	-	-	-	BBN001551320190000.	-	-	-
1000	400	BBN001571510190000.	-	-	-	BBN001571320190000.	-	-	-

H1820 mm

Achsmaß mm	FB Tiefe mm	Bestell-Nr. Freistehendes Regal	Melamin	Lackiert	Furniert	Bestell-Nr. Mittel Regal	Melamin	Lackiert	Furniert
500	250	BBN001635510190000.	-	-	-	BBN001635320190000.	-	-	-
500	300	BBN001655510190000.	-	-	-	BBN001655320190000.	-	-	-
500	400	BBN001675510190000.	-	-	-	BBN001675320190000.	-	-	-
750	250	BBN001637510190000.	-	-	-	BBN001637320190000.	-	-	-
750	300	BBN001657510190000.	-	-	-	BBN001657320190000.	-	-	-
750	400	BBN001677510190000.	-	-	-	BBN001677320190000.	-	-	-
900	250	BBN001639510190000.	-	-	-	BBN001639320190000.	-	-	-
900	300	BBN001659510190000.	-	-	-	BBN001659320190000.	-	-	-
900	400	BBN001679510190000.	-	-	-	BBN001679320190000.	-	-	-
1000	250	BBN001631510190000.	-	-	-	BBN001631320190000.	-	-	-
1000	300	BBN001651510190000.	-	-	-	BBN001651320190000.	-	-	-
1000	400	BBN001671510190000.	-	-	-	BBN001671320190000.	-	-	-

H2120 mm

Achsmaß mm	FB Tiefe mm	Bestell-Nr. Freistehendes Regal	Melamin	Lackiert	Furniert	Bestell-Nr. Mittel Regal	Melamin	Lackiert	Furniert
500	250	BBN001735510190000.	-	-	-	BBN001735320190000.	-	-	-
500	300	BBN001755510190000.	-	-	-	BBN001755320190000.	-	-	-
500	400	BBN001775510190000.	-	-	-	BBN001775320190000.	-	-	-
750	250	BBN001737510190000.	-	-	-	BBN001737320190000.	-	-	-
750	300	BBN001757510190000.	-	-	-	BBN001757320190000.	-	-	-
750	400	BBN001777510190000.	-	-	-	BBN001777320190000.	-	-	-
900	250	BBN001739510190000.	-	-	-	BBN001739320190000.	-	-	-
900	300	BBN001759510190000.	-	-	-	BBN001759320190000.	-	-	-
900	400	BBN001779510190000.	-	-	-	BBN001779320190000.	-	-	-
1000	250	BBN001731510190000.	-	-	-	BBN001731320190000.	-	-	-
1000	300	BBN001751510190000.	-	-	-	BBN001751320190000.	-	-	-
1000	400	BBN001771510190000.	-	-	-	BBN001771320190000.	-	-	-

LINGO REGALSYSTEM

DOPPELSEITIG - DIAGONALTRAVERSE - STELLFÜßE - FÜR ABDECKFACHBODEN

Lackierte und furnierte Lingo Regale haben das FSC Zertifikat.

H720 mm

Achismaß mm	FB Tiefe mm	Bestell-Nr. Freistehendes Regal	Melamin	Lackiert	Furniert	Bestell-Nr. Mittel Regal	Melamin	Lackiert	Furniert
500	250	BBN001245510190000.	-	-	-	BBN001245320190000.	-	-	-
500	300	BBN001265510190000.	-	-	-	BBN001265320190000.	-	-	-
500	400	BBN001285510190000.	-	-	-	BBN001285320190000.	-	-	-
750	250	BBN001247510190000.	-	-	-	BBN001247320190000.	-	-	-
750	300	BBN001267510190000.	-	-	-	BBN001267320190000.	-	-	-
750	400	BBN001287510190000.	-	-	-	BBN001287320190000.	-	-	-
900	250	BBN001249510190000.	-	-	-	BBN001249320190000.	-	-	-
900	300	BBN001269510190000.	-	-	-	BBN001269320190000.	-	-	-
900	400	BBN001289510190000.	-	-	-	BBN001289320190000.	-	-	-
1000	250	BBN001241510190000.	-	-	-	BBN001241320190000.	-	-	-
1000	300	BBN001261510190000.	-	-	-	BBN001261320190000.	-	-	-
1000	400	BBN001281510190000.	-	-	-	BBN001281320190000.	-	-	-

H920 mm

Achismaß mm	FB Tiefe mm	Bestell-Nr. Freistehendes Regal	Melamin	Lackiert	Furniert	Bestell-Nr. Mittel Regal	Melamin	Lackiert	Furniert
500	250	BBN001345510190000.	-	-	-	BBN001345320190000.	-	-	-
500	300	BBN001365510190000.	-	-	-	BBN001365320190000.	-	-	-
500	400	BBN001385510190000.	-	-	-	BBN001385320190000.	-	-	-
750	250	BBN001347510190000.	-	-	-	BBN001347320190000.	-	-	-
750	300	BBN001367510190000.	-	-	-	BBN001367320190000.	-	-	-
750	400	BBN001387510190000.	-	-	-	BBN001387320190000.	-	-	-
900	250	BBN001349510190000.	-	-	-	BBN001349320190000.	-	-	-
900	300	BBN001369510190000.	-	-	-	BBN001369320190000.	-	-	-
900	400	BBN001389510190000.	-	-	-	BBN001389320190000.	-	-	-
1000	250	BBN001341510190000.	-	-	-	BBN001341320190000.	-	-	-
1000	300	BBN001361510190000.	-	-	-	BBN001361320190000.	-	-	-
1000	400	BBN001381510190000.	-	-	-	BBN001381320190000.	-	-	-

H1220 mm

Achismaß mm	FB Tiefe mm	Bestell-Nr. Freistehendes Regal	Melamin	Lackiert	Furniert	Bestell-Nr. Mittel Regal	Melamin	Lackiert	Furniert
500	250	BBN001445510190000.	-	-	-	BBN001445320190000.	-	-	-
500	300	BBN001465510190000.	-	-	-	BBN001465320190000.	-	-	-
500	400	BBN001485510190000.	-	-	-	BBN001485320190000.	-	-	-
750	250	BBN001447510190000.	-	-	-	BBN001447320190000.	-	-	-
750	300	BBN001467510190000.	-	-	-	BBN001467320190000.	-	-	-
750	400	BBN001487510190000.	-	-	-	BBN001487320190000.	-	-	-
900	250	BBN001449510190000.	-	-	-	BBN001449320190000.	-	-	-
900	300	BBN001469510190000.	-	-	-	BBN001469320190000.	-	-	-
900	400	BBN001489510190000.	-	-	-	BBN001489320190000.	-	-	-
1000	250	BBN001441510190000.	-	-	-	BBN001441320190000.	-	-	-
1000	300	BBN001461510190000.	-	-	-	BBN001461320190000.	-	-	-
1000	400	BBN001481510190000.	-	-	-	BBN001481320190000.	-	-	-

LINGO REGALSYSTEM

DOPPELSEITIG - DIAGONALTRAVERSE - STELLFÜßE - FÜR ABDECKFACHBODEN

Lackierte und furnierte Lingo Regale haben das FSC Zertifikat.

H1520 mm

Achsmaß mm	FB Tiefe mm	Bestell-Nr. Freistehendes Regal	Melamin	Lackiert	Furniert	Bestell-Nr. Mittel Regal	Melamin	Lackiert	Furniert
500	250	BBN001545510190000.	-	-	-	BBN001545320190000.	-	-	-
500	300	BBN001565510190000.	-	-	-	BBN001565320190000.	-	-	-
500	400	BBN001585510190000.	-	-	-	BBN001585320190000.	-	-	-
750	250	BBN001547510190000.	-	-	-	BBN001547320190000.	-	-	-
750	300	BBN001567510190000.	-	-	-	BBN001567320190000.	-	-	-
750	400	BBN001587510190000.	-	-	-	BBN001587320190000.	-	-	-
900	250	BBN001549510190000.	-	-	-	BBN001549320190000.	-	-	-
900	300	BBN001569510190000.	-	-	-	BBN001569320190000.	-	-	-
900	400	BBN001589510190000.	-	-	-	BBN001589320190000.	-	-	-
1000	250	BBN001541510190000.	-	-	-	BBN001541320190000.	-	-	-
1000	300	BBN001561510190000.	-	-	-	BBN001561320190000.	-	-	-
1000	400	BBN001581510190000.	-	-	-	BBN001581320190000.	-	-	-

H1820 mm

Achsmaß mm	FB Tiefe mm	Bestell-Nr. Freistehendes Regal	Melamin	Lackiert	Furniert	Bestell-Nr. Mittel Regal	Melamin	Lackiert	Furniert
500	250	BBN001645510190000.	-	-	-	BBN001645320190000.	-	-	-
500	300	BBN001665510190000.	-	-	-	BBN001665320190000.	-	-	-
500	400	BBN001685510190000.	-	-	-	BBN001685320190000.	-	-	-
750	250	BBN001647510190000.	-	-	-	BBN001647320190000.	-	-	-
750	300	BBN001667510190000.	-	-	-	BBN001667320190000.	-	-	-
750	400	BBN001687510190000.	-	-	-	BBN001687320190000.	-	-	-
900	250	BBN001649510190000.	-	-	-	BBN001649320190000.	-	-	-
900	300	BBN001669510190000.	-	-	-	BBN001669320190000.	-	-	-
900	400	BBN001689510190000.	-	-	-	BBN001689320190000.	-	-	-
1000	250	BBN001641510190000.	-	-	-	BBN001641320190000.	-	-	-
1000	300	BBN001661510190000.	-	-	-	BBN001661320190000.	-	-	-
1000	400	BBN001681510190000.	-	-	-	BBN001681320190000.	-	-	-

H2120 mm

Achsmaß mm	FB Tiefe mm	Bestell-Nr. Freistehendes Regal	Melamin	Lackiert	Furniert	Bestell-Nr. Mittel Regal	Melamin	Lackiert	Furniert
500	250	BBN001745510190000.	-	-	-	BBN001745320190000.	-	-	-
500	300	BBN001765510190000.	-	-	-	BBN001765320190000.	-	-	-
500	400	BBN001785510190000.	-	-	-	BBN001785320190000.	-	-	-
750	250	BBN001747510190000.	-	-	-	BBN001747320190000.	-	-	-
750	300	BBN001767510190000.	-	-	-	BBN001767320190000.	-	-	-
750	400	BBN001787510190000.	-	-	-	BBN001787320190000.	-	-	-
900	250	BBN001749510190000.	-	-	-	BBN001749320190000.	-	-	-
900	300	BBN001769510190000.	-	-	-	BBN001769320190000.	-	-	-
900	400	BBN001789510190000.	-	-	-	BBN001789320190000.	-	-	-
1000	250	BBN001741510190000.	-	-	-	BBN001741320190000.	-	-	-
1000	300	BBN001761510190000.	-	-	-	BBN001761320190000.	-	-	-
1000	400	BBN001781510190000.	-	-	-	BBN001781320190000.	-	-	-

LINGO REGALSYSTEM

BBN002 - RAHMEN TRAVVERSE - STELLFÜßE - MIT HOLZABDECKPLATTE



LINGO REGALSYSTEM

BBN002 - RAHMENRAVERSE - STELLFÜßE - MIT HOLZABDECKPLATTE

Regalsystem mit Holzseiten, Metallrahmenraverse und überliegender Holzabdeckplatte. Für Konfigurationen mit mehr als 3 Sektionen, bitte kontaktieren Sie unsere Verkaufsabteilung.

- Preis basiert auf Metallpreisgruppe 1 und Holzpreisgruppe A (siehe Designauswahl Seiten 6-9).
- Für Fachböden siehe Seite 128.
- Für Funktionen siehe Seite 168.

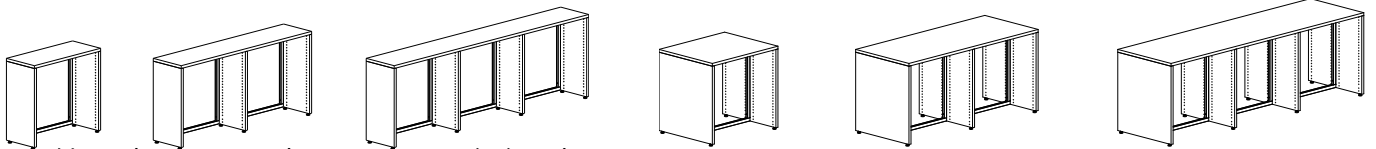

Ein-/doppelseitiges Regal - H720 mm - 1/2/3 Sektionen

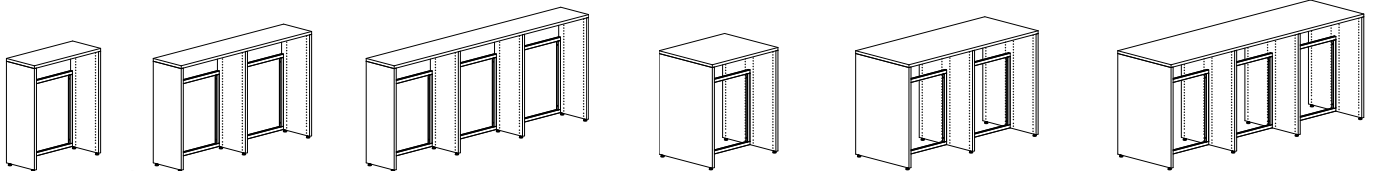

Ein-/doppelseitiges Regal - H920 mm - 1/2/3 Sektionen

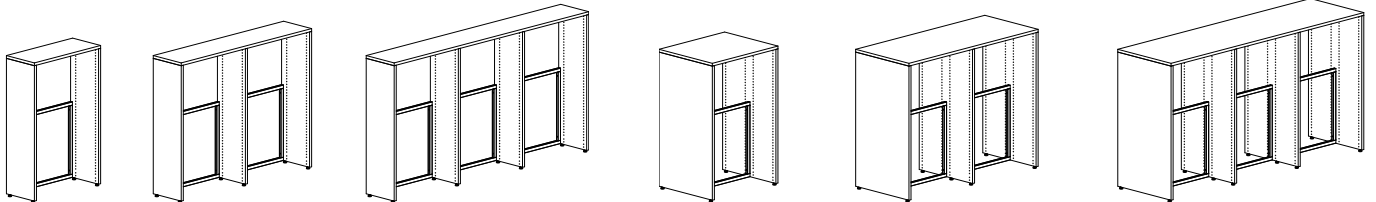

Ein-/doppelseitiges Regal - H1220 mm - 1/2/3 Sektionen

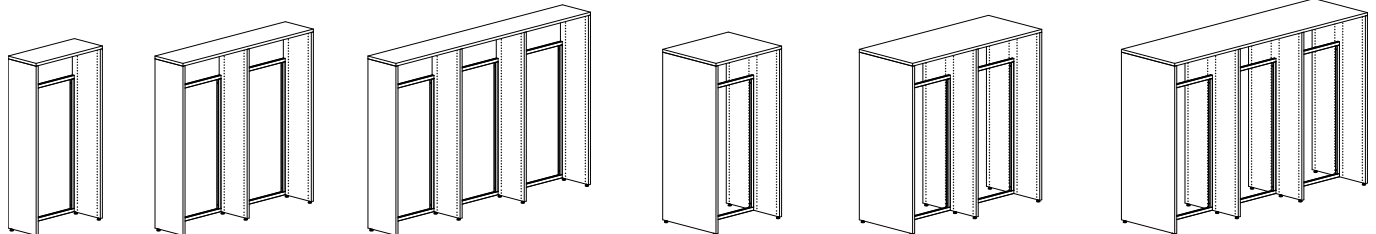

Ein-/doppelseitiges Regal - H1520 mm - 1/2/3 Sektionen

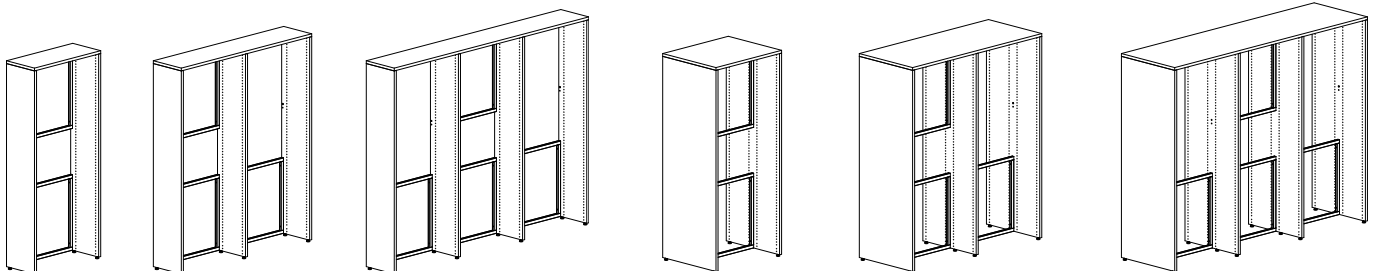

Ein-/doppelseitiges Regal - H1820 mm - 1/2/3 Sektionen

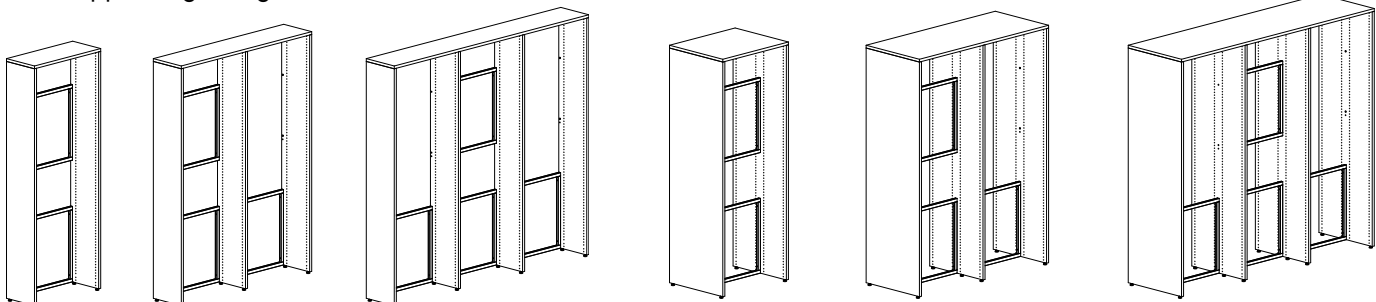

Ein-/doppelseitiges Regal - H2120 mm - 1/2/3 Sektionen

LINGO REGALSYSTEM

EINSEITIG - RAHMENRAVERSE - STELLFÜßE - MIT HOLZABDECKPLATTE

Lackierte und furnierte Lingo Regale haben das FSC Zertifikat.

H720 mm

Achsmaß mm	FB Tiefe mm	Sektionen	Bestell-Nr.	Melamin	Lackiert	Furniert
500	250	1	BBN00223551016000.	-	-	-
500	250	2	BBN00223551026000.	-	-	-
500	250	3	BBN00223551036000.	-	-	-
500	300	1	BBN00225551016000.	-	-	-
500	300	2	BBN00225551026000.	-	-	-
500	300	3	BBN00225551036000.	-	-	-
500	400	1	BBN00227551016000.	-	-	-
500	400	2	BBN00227551026000.	-	-	-
500	400	3	BBN00227551036000.	-	-	-
750	250	1	BBN00223751016000.	-	-	-
750	250	2	BBN00223751026000.	-	-	-
750	250	3	BBN00223751036000.	-	-	-
750	300	1	BBN00225751016000.	-	-	-
750	300	2	BBN00225751026000.	-	-	-
750	300	3	BBN00225751036000.	-	-	-
750	400	1	BBN00227751016000.	-	-	-
750	400	2	BBN00227751026000.	-	-	-
750	400	3	BBN00227751036000.	-	-	-
900	250	1	BBN00223951016000.	-	-	-
900	250	2	BBN00223951026000.	-	-	-
900	300	1	BBN00225951016000.	-	-	-
900	300	2	BBN00225951026000.	-	-	-
900	400	1	BBN00227951016000.	-	-	-
900	400	2	BBN00227951026000.	-	-	-
1000	250	1	BBN00223151016000.	-	-	-
1000	250	2	BBN00223151026000.	-	-	-
1000	300	1	BBN00225151016000.	-	-	-
1000	300	2	BBN00225151026000.	-	-	-
1000	400	1	BBN00227151016000.	-	-	-
1000	400	2	BBN00227151026000.	-	-	-

LINGO REGALSYSTEM

EINSEITIG - RAHMENRAVERSE - STELLFÜßE - MIT HOLZABDECKPLATTE

Lackierte und furnierte Lingo Regale haben das FSC Zertifikat.

H920 mm

Achsmaß mm	FB Tiefe mm	Sektionen	Bestell-Nr.	Melamin	Lackiert	Furniert
500	250	1	BBN00233551016000.	-	-	-
500	250	2	BBN00233551026000.	-	-	-
500	250	3	BBN00233551036000.	-	-	-
500	300	1	BBN00235551016000.	-	-	-
500	300	2	BBN00235551026000.	-	-	-
500	300	3	BBN00235551036000.	-	-	-
500	400	1	BBN00237551016000.	-	-	-
500	400	2	BBN00237551026000.	-	-	-
500	400	3	BBN00237551036000.	-	-	-
750	250	1	BBN00233751016000.	-	-	-
750	250	2	BBN00233751026000.	-	-	-
750	250	3	BBN00233751036000.	-	-	-
750	300	1	BBN00235751016000.	-	-	-
750	300	2	BBN00235751026000.	-	-	-
750	300	3	BBN00235751036000.	-	-	-
750	400	1	BBN00237751016000.	-	-	-
750	400	2	BBN00237751026000.	-	-	-
750	400	3	BBN00237751036000.	-	-	-
900	250	1	BBN00233951016000.	-	-	-
900	250	2	BBN00233951026000.	-	-	-
900	300	1	BBN00235951016000.	-	-	-
900	300	2	BBN00235951026000.	-	-	-
900	400	1	BBN00237951016000.	-	-	-
900	400	2	BBN00237951026000.	-	-	-
1000	250	1	BBN00233151016000.	-	-	-
1000	250	2	BBN00233151026000.	-	-	-
1000	300	1	BBN00235151016000.	-	-	-
1000	300	2	BBN00235151026000.	-	-	-
1000	400	1	BBN00237151016000.	-	-	-
1000	400	2	BBN00237151026000.	-	-	-

LINGO REGALSYSTEM

EINSEITIG - RAHMENRAVERSE - STELLFÜßE - MIT HOLZABDECKPLATTE

Lackierte und furnierte Lingo Regale haben das FSC Zertifikat.

H1220 mm

Achsmaß mm	FB Tiefe mm	Sektionen	Bestell-Nr.	Melamin	Lackiert	Furniert
500	250	1	BBN00243551016000.	-	-	-
500	250	2	BBN00243551026000.	-	-	-
500	250	3	BBN00243551036000.	-	-	-
500	300	1	BBN00245551016000.	-	-	-
500	300	2	BBN00245551026000.	-	-	-
500	300	3	BBN00245551036000.	-	-	-
500	400	1	BBN00247551016000.	-	-	-
500	400	2	BBN00247551026000.	-	-	-
500	400	3	BBN00247551036000.	-	-	-
750	250	1	BBN00243751016000.	-	-	-
750	250	2	BBN00243751026000.	-	-	-
750	250	3	BBN00243751036000.	-	-	-
750	300	1	BBN00245751016000.	-	-	-
750	300	2	BBN00245751026000.	-	-	-
750	300	3	BBN00245751036000.	-	-	-
750	400	1	BBN00247751016000.	-	-	-
750	400	2	BBN00247751026000.	-	-	-
750	400	3	BBN00247751036000.	-	-	-
900	250	1	BBN00243951016000.	-	-	-
900	250	2	BBN00243951026000.	-	-	-
900	300	1	BBN00245951016000.	-	-	-
900	300	2	BBN00245951026000.	-	-	-
900	400	1	BBN00247951016000.	-	-	-
900	400	2	BBN00247951026000.	-	-	-
1000	250	1	BBN00243151016000.	-	-	-
1000	250	2	BBN00243151026000.	-	-	-
1000	300	1	BBN00245151016000.	-	-	-
1000	300	2	BBN00245151026000.	-	-	-
1000	400	1	BBN00247151016000.	-	-	-
1000	400	2	BBN00247151026000.	-	-	-

LINGO REGALSYSTEM

EINSEITIG - RAHMENRAVERSE - STELLFÜßE - MIT HOLZABDECKPLATTE

Lackierte und furnierte Lingo Regale haben das FSC Zertifikat.

H1520 mm

Achsmaß mm	FB Tiefe mm	Sektionen	Bestell-Nr.	Melamin	Lackiert	Furniert
500	250	1	BBN00253551016000.	-	-	-
500	250	2	BBN00253551026000.	-	-	-
500	250	3	BBN00253551036000.	-	-	-
500	300	1	BBN00255551016000.	-	-	-
500	300	2	BBN00255551026000.	-	-	-
500	300	3	BBN00255551036000.	-	-	-
500	400	1	BBN00257551016000.	-	-	-
500	400	2	BBN00257551026000.	-	-	-
500	400	3	BBN00257551036000.	-	-	-
750	250	1	BBN00253751016000.	-	-	-
750	250	2	BBN00253751026000.	-	-	-
750	250	3	BBN00253751036000.	-	-	-
750	300	1	BBN00255751016000.	-	-	-
750	300	2	BBN00255751026000.	-	-	-
750	300	3	BBN00255751036000.	-	-	-
750	400	1	BBN00257751016000.	-	-	-
750	400	2	BBN00257751026000.	-	-	-
750	400	3	BBN00257751036000.	-	-	-
900	250	1	BBN00253951016000.	-	-	-
900	250	2	BBN00253951026000.	-	-	-
900	300	1	BBN00255951016000.	-	-	-
900	300	2	BBN00255951026000.	-	-	-
900	400	1	BBN00257951016000.	-	-	-
900	400	2	BBN00257951026000.	-	-	-
1000	250	1	BBN00253151016000.	-	-	-
1000	250	2	BBN00253151026000.	-	-	-
1000	300	1	BBN00255151016000.	-	-	-
1000	300	2	BBN00255151026000.	-	-	-
1000	400	1	BBN00257151016000.	-	-	-
1000	400	2	BBN00257151026000.	-	-	-

LINGO REGALSYSTEM

EINSEITIG - RAHMENRAVERSE - STELLFÜßE - MIT HOLZABDECKPLATTE

Lackierte und furnierte Lingo Regale haben das FSC Zertifikat.

H1820 mm

Achsmaß mm	FB Tiefe mm	Sektionen	Bestell-Nr.	Melamin	Lackiert	Furniert
500	250	1	BBN00263551016000.	-	-	-
500	250	2	BBN00263551026000.	-	-	-
500	250	3	BBN00263551036000.	-	-	-
500	300	1	BBN00265551016000.	-	-	-
500	300	2	BBN00265551026000.	-	-	-
500	300	3	BBN00265551036000.	-	-	-
500	400	1	BBN00267551016000.	-	-	-
500	400	2	BBN00267551026000.	-	-	-
500	400	3	BBN00267551036000.	-	-	-
750	250	1	BBN00263751016000.	-	-	-
750	250	2	BBN00263751026000.	-	-	-
750	250	3	BBN00263751036000.	-	-	-
750	300	1	BBN00265751016000.	-	-	-
750	300	2	BBN00265751026000.	-	-	-
750	300	3	BBN00265751036000.	-	-	-
750	400	1	BBN00267751016000.	-	-	-
750	400	2	BBN00267751026000.	-	-	-
750	400	3	BBN00267751036000.	-	-	-
900	250	1	BBN00263951016000.	-	-	-
900	250	2	BBN00263951026000.	-	-	-
900	300	1	BBN00265951016000.	-	-	-
900	300	2	BBN00265951026000.	-	-	-
900	400	1	BBN00267951016000.	-	-	-
900	400	2	BBN00267951026000.	-	-	-
1000	250	1	BBN00263151016000.	-	-	-
1000	250	2	BBN00263151026000.	-	-	-
1000	300	1	BBN00265151016000.	-	-	-
1000	300	2	BBN00265151026000.	-	-	-
1000	400	1	BBN00267151016000.	-	-	-
1000	400	2	BBN00267151026000.	-	-	-

LINGO REGALSYSTEM

EINSEITIG - RAHMENRAVERSE - STELLFÜßE - MIT HOLZABDECKPLATTE

Lackierte und furnierte Lingo Regale haben das FSC Zertifikat.

H2120 mm

Achsmaß mm	FB Tiefe mm	Sektionen	Bestell-Nr.	Melamin	Lackiert	Furniert
500	250	1	BBN00273551016000.	-	-	-
500	250	2	BBN00273551026000.	-	-	-
500	250	3	BBN00273551036000.	-	-	-
500	300	1	BBN00275551016000.	-	-	-
500	300	2	BBN00275551026000.	-	-	-
500	300	3	BBN00275551036000.	-	-	-
500	400	1	BBN00277551016000.	-	-	-
500	400	2	BBN00277551026000.	-	-	-
500	400	3	BBN00277551036000.	-	-	-
750	250	1	BBN00273751016000.	-	-	-
750	250	2	BBN00273751026000.	-	-	-
750	250	3	BBN00273751036000.	-	-	-
750	300	1	BBN00275751016000.	-	-	-
750	300	2	BBN00275751026000.	-	-	-
750	300	3	BBN00275751036000.	-	-	-
750	400	1	BBN00277751016000.	-	-	-
750	400	2	BBN00277751026000.	-	-	-
750	400	3	BBN00277751036000.	-	-	-
900	250	1	BBN00273951016000.	-	-	-
900	250	2	BBN00273951026000.	-	-	-
900	300	1	BBN00275951016000.	-	-	-
900	300	2	BBN00275951026000.	-	-	-
900	400	1	BBN00277951016000.	-	-	-
900	400	2	BBN00277951026000.	-	-	-
1000	250	1	BBN00273151016000.	-	-	-
1000	250	2	BBN00273151026000.	-	-	-
1000	300	1	BBN00275151016000.	-	-	-
1000	300	2	BBN00275151026000.	-	-	-
1000	400	1	BBN00277151016000.	-	-	-
1000	400	2	BBN00277151026000.	-	-	-

LINGO REGALSYSTEM

DOPPELSEITIG - RAHMENRAVERSE - STELLFÜßE - MIT HOLZABDECKPLATTE

Lackierte und furnierte Lingo Regale haben das FSC Zertifikat.

H720 mm

Achsmaß mm	FB Tiefe mm	Sektionen	Bestell-Nr.	Melamin	Lackiert	Furniert
500	250	1	BBN00224551016000.	-	-	-
500	250	2	BBN00224551026000.	-	-	-
500	250	3	BBN00224551036000.	-	-	-
500	300	1	BBN00226551016000.	-	-	-
500	300	2	BBN00226551026000.	-	-	-
500	300	3	BBN00226551036000.	-	-	-
500	400	1	BBN00228551016000.	-	-	-
500	400	2	BBN00228551026000.	-	-	-
500	400	3	BBN00228551036000.	-	-	-
750	250	1	BBN00224751016000.	-	-	-
750	250	2	BBN00224751026000.	-	-	-
750	250	3	BBN00224751036000.	-	-	-
750	300	1	BBN00226751016000.	-	-	-
750	300	2	BBN00226751026000.	-	-	-
750	300	3	BBN00226751036000.	-	-	-
750	400	1	BBN00228751016000.	-	-	-
750	400	2	BBN00228751026000.	-	-	-
750	400	3	BBN00228751036000.	-	-	-
900	250	1	BBN00224951016000.	-	-	-
900	250	2	BBN00224951026000.	-	-	-
900	300	1	BBN00226951016000.	-	-	-
900	300	2	BBN00226951026000.	-	-	-
900	400	1	BBN00228951016000.	-	-	-
900	400	2	BBN00228951026000.	-	-	-
1000	250	1	BBN00224151016000.	-	-	-
1000	250	2	BBN00224151026000.	-	-	-
1000	300	1	BBN00226151016000.	-	-	-
1000	300	2	BBN00226151026000.	-	-	-
1000	400	1	BBN00228151016000.	-	-	-
1000	400	2	BBN00228151026000.	-	-	-

LINGO REGALSYSTEM

DOPPELSEITIG - RAHMENRAVERSE - STELLFÜßE - MIT HOLZABDECKPLATTE

Lackierte und furnierte Lingo Regale haben das FSC Zertifikat.

H920 mm

Achsmaß mm	FB Tiefe mm	Sektionen	Bestell-Nr.	Melamin	Lackiert	Furniert
500	250	1	BBN00234551016000.	-	-	-
500	250	2	BBN00234551026000.	-	-	-
500	250	3	BBN00234551036000.	-	-	-
500	300	1	BBN00236551016000.	-	-	-
500	300	2	BBN00236551026000.	-	-	-
500	300	3	BBN00236551036000.	-	-	-
500	400	1	BBN00238551016000.	-	-	-
500	400	2	BBN00238551026000.	-	-	-
500	400	3	BBN00238551036000.	-	-	-
750	250	1	BBN00234751016000.	-	-	-
750	250	2	BBN00234751026000.	-	-	-
750	250	3	BBN00234751036000.	-	-	-
750	300	1	BBN00236751016000.	-	-	-
750	300	2	BBN00236751026000.	-	-	-
750	300	3	BBN00236751036000.	-	-	-
750	400	1	BBN00238751016000.	-	-	-
750	400	2	BBN00238751026000.	-	-	-
750	400	3	BBN00238751036000.	-	-	-
900	250	1	BBN00234951016000.	-	-	-
900	250	2	BBN00234951026000.	-	-	-
900	300	1	BBN00236951016000.	-	-	-
900	300	2	BBN00236951026000.	-	-	-
900	400	1	BBN00238951016000.	-	-	-
900	400	2	BBN00238951026000.	-	-	-
1000	250	1	BBN00234151016000.	-	-	-
1000	250	2	BBN00234151026000.	-	-	-
1000	300	1	BBN00236151016000.	-	-	-
1000	300	2	BBN00236151026000.	-	-	-
1000	400	1	BBN00238151016000.	-	-	-
1000	400	2	BBN00238151026000.	-	-	-

LINGO REGALSYSTEM

DOPPELSEITIG - RAHMENRAVERSE - STELLFÜßE - MIT HOLZABDECKPLATTE

Lackierte und furnierte Lingo Regale haben das FSC Zertifikat.

H1220 mm

Achsmaß mm	FB Tiefe mm	Sektionen	Bestell-Nr.	Melamin	Lackiert	Furniert
500	250	1	BBN00244551016000.	-	-	-
500	250	2	BBN00244551026000.	-	-	-
500	250	3	BBN00244551036000.	-	-	-
500	300	1	BBN00246551016000.	-	-	-
500	300	2	BBN00246551026000.	-	-	-
500	300	3	BBN00246551036000.	-	-	-
500	400	1	BBN00248551016000.	-	-	-
500	400	2	BBN00248551026000.	-	-	-
500	400	3	BBN00248551036000.	-	-	-
750	250	1	BBN00244751016000.	-	-	-
750	250	2	BBN00244751026000.	-	-	-
750	250	3	BBN00244751036000.	-	-	-
750	300	1	BBN00246751016000.	-	-	-
750	300	2	BBN00246751026000.	-	-	-
750	300	3	BBN00246751036000.	-	-	-
750	400	1	BBN00248751016000.	-	-	-
750	400	2	BBN00248751026000.	-	-	-
750	400	3	BBN00248751036000.	-	-	-
900	250	1	BBN00244951016000.	-	-	-
900	250	2	BBN00244951026000.	-	-	-
900	300	1	BBN00246951016000.	-	-	-
900	300	2	BBN00246951026000.	-	-	-
900	400	1	BBN00248951016000.	-	-	-
900	400	2	BBN00248951026000.	-	-	-
1000	250	1	BBN00244151016000.	-	-	-
1000	250	2	BBN00244151026000.	-	-	-
1000	300	1	BBN00246151016000.	-	-	-
1000	300	2	BBN00246151026000.	-	-	-
1000	400	1	BBN00248151016000.	-	-	-
1000	400	2	BBN00248151026000.	-	-	-

LINGO REGALSYSTEM

DOPPELSEITIG - RAHMENRAVERSE - STELLFÜßE - MIT HOLZABDECKPLATTE

Lackierte und furnierte Lingo Regale haben das FSC Zertifikat.

H1520 mm

Achsmaß mm	FB Tiefe mm	Sektionen	Bestell-Nr.	Melamin	Lackiert	Furniert
500	250	1	BBN00254551016000.	-	-	-
500	250	2	BBN00254551026000.	-	-	-
500	250	3	BBN00254551036000.	-	-	-
500	300	1	BBN00256551016000.	-	-	-
500	300	2	BBN00256551026000.	-	-	-
500	300	3	BBN00256551036000.	-	-	-
500	400	1	BBN00258551016000.	-	-	-
500	400	2	BBN00258551026000.	-	-	-
500	400	3	BBN00258551036000.	-	-	-
750	250	1	BBN00254751016000.	-	-	-
750	250	2	BBN00254751026000.	-	-	-
750	250	3	BBN00254751036000.	-	-	-
750	300	1	BBN00256751016000.	-	-	-
750	300	2	BBN00256751026000.	-	-	-
750	300	3	BBN00256751036000.	-	-	-
750	400	1	BBN00258751016000.	-	-	-
750	400	2	BBN00258751026000.	-	-	-
750	400	3	BBN00258751036000.	-	-	-
900	250	1	BBN00254951016000.	-	-	-
900	250	2	BBN00254951026000.	-	-	-
900	300	1	BBN00256951016000.	-	-	-
900	300	2	BBN00256951026000.	-	-	-
900	400	1	BBN00258951016000.	-	-	-
900	400	2	BBN00258951026000.	-	-	-
1000	250	1	BBN00254151016000.	-	-	-
1000	250	2	BBN00254151026000.	-	-	-
1000	300	1	BBN00256151016000.	-	-	-
1000	300	2	BBN00256151026000.	-	-	-
1000	400	1	BBN00258151016000.	-	-	-
1000	400	2	BBN00258151026000.	-	-	-

LINGO REGALSYSTEM

DOPPELSEITIG - RAHMENRAVERSE - STELLFÜßE - MIT HOLZABDECKPLATTE

Lackierte und furnierte Lingo Regale haben das FSC Zertifikat.

H1820 mm

Achsmaß mm	FB Tiefe mm	Sektionen	Bestell-Nr.	Melamin	Lackiert	Furniert
500	250	1	BBN00264551016000.	-	-	-
500	250	2	BBN00264551026000.	-	-	-
500	250	3	BBN00264551036000.	-	-	-
500	300	1	BBN00266551016000.	-	-	-
500	300	2	BBN00266551026000.	-	-	-
500	300	3	BBN00266551036000.	-	-	-
500	400	1	BBN00268551016000.	-	-	-
500	400	2	BBN00268551026000.	-	-	-
500	400	3	BBN00268551036000.	-	-	-
750	250	1	BBN00264751016000.	-	-	-
750	250	2	BBN00264751026000.	-	-	-
750	250	3	BBN00264751036000.	-	-	-
750	300	1	BBN00266751016000.	-	-	-
750	300	2	BBN00266751026000.	-	-	-
750	300	3	BBN00266751036000.	-	-	-
750	400	1	BBN00268751016000.	-	-	-
750	400	2	BBN00268751026000.	-	-	-
750	400	3	BBN00268751036000.	-	-	-
900	250	1	BBN00264951016000.	-	-	-
900	250	2	BBN00264951026000.	-	-	-
900	300	1	BBN00266951016000.	-	-	-
900	300	2	BBN00266951026000.	-	-	-
900	400	1	BBN00268951016000.	-	-	-
900	400	2	BBN00268951026000.	-	-	-
1000	250	1	BBN00264151016000.	-	-	-
1000	250	2	BBN00264151026000.	-	-	-
1000	300	1	BBN00266151016000.	-	-	-
1000	300	2	BBN00266151026000.	-	-	-
1000	400	1	BBN00268151016000.	-	-	-
1000	400	2	BBN00268151026000.	-	-	-

LINGO REGALSYSTEM

DOPPELSEITIG - RAHMENRAVERSE - STELLFÜßE - MIT HOLZABDECKPLATTE

Lackierte und furnierte Lingo Regale haben das FSC Zertifikat.

H2120 mm

Achsmaß mm	FB Tiefe mm	Sektionen	Bestell-Nr.	Melamin	Lackiert	Furniert
500	250	1	BBN00274551016000.	-	-	-
500	250	2	BBN00274551026000.	-	-	-
500	250	3	BBN00274551036000.	-	-	-
500	300	1	BBN00276551016000.	-	-	-
500	300	2	BBN00276551026000.	-	-	-
500	300	3	BBN00276551036000.	-	-	-
500	400	1	BBN00278551016000.	-	-	-
500	400	2	BBN00278551026000.	-	-	-
500	400	3	BBN00278551036000.	-	-	-
750	250	1	BBN00274751016000.	-	-	-
750	250	2	BBN00274751026000.	-	-	-
750	250	3	BBN00274751036000.	-	-	-
750	300	1	BBN00276751016000.	-	-	-
750	300	2	BBN00276751026000.	-	-	-
750	300	3	BBN00276751036000.	-	-	-
750	400	1	BBN00278751016000.	-	-	-
750	400	2	BBN00278751026000.	-	-	-
750	400	3	BBN00278751036000.	-	-	-
900	250	1	BBN00274951016000.	-	-	-
900	250	2	BBN00274951026000.	-	-	-
900	300	1	BBN00276951016000.	-	-	-
900	300	2	BBN00276951026000.	-	-	-
900	400	1	BBN00278951016000.	-	-	-
900	400	2	BBN00278951026000.	-	-	-
1000	250	1	BBN00274151016000.	-	-	-
1000	250	2	BBN00274151026000.	-	-	-
1000	300	1	BBN00276151016000.	-	-	-
1000	300	2	BBN00276151026000.	-	-	-
1000	400	1	BBN00278151016000.	-	-	-
1000	400	2	BBN00278151026000.	-	-	-

LINGO REGALSYSTEM

BBN002 - RÜCKWAND - STELFÜßE - MIT HOLZABDECKPLATTE



LINGO REGALSYSTEM

BBN002 - RÜCKWAND - STELLFÜßE - MIT HOLZABDECKPLATTE

Regalsystem mit Holzseiten, Holzrückwand und überliegendem Holzabdeckplatte.
Für Konfigurationen mit mehr als 3 Sektionen, bitte kontaktieren Sie unsere Verkaufsabteilung.

- Preis basiert auf Metallpreisgruppe 1 und Holzpreisgruppe A (siehe Designauswahl Seiten 6-9).
- Für Fachböden siehe Seite 128.
- Für Funktionen siehe Seite 168.

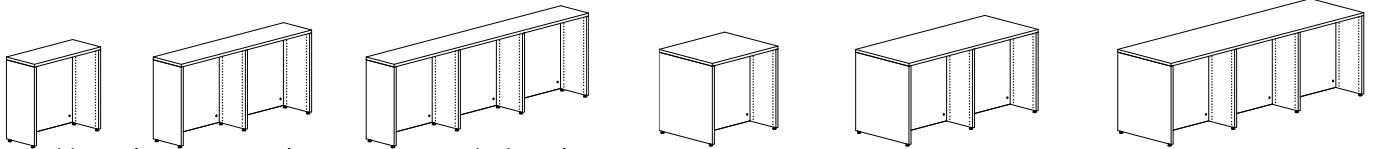

Ein-/doppelseitiges Regal - H720 mm - 1/2/3 Sektionen

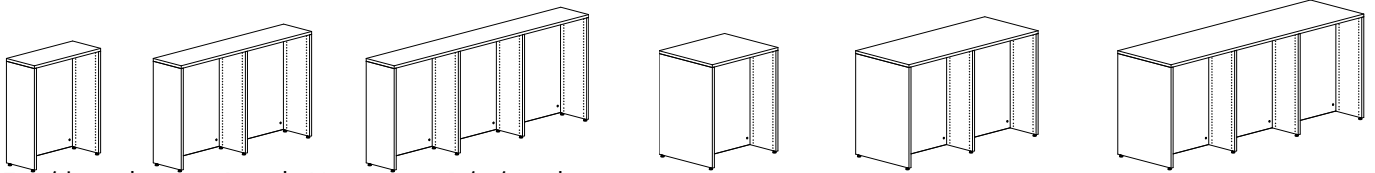

Ein-/doppelseitiges Regal - H920 mm - 1/2/3 Sektionen

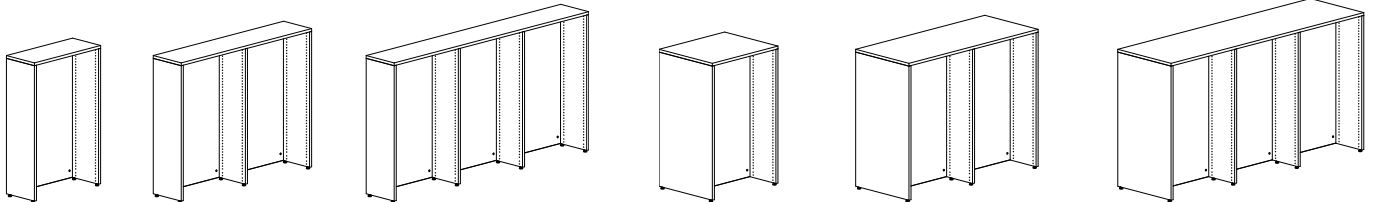

Ein-/doppelseitiges Regal - H1220 mm - 1/2/3 Sektionen

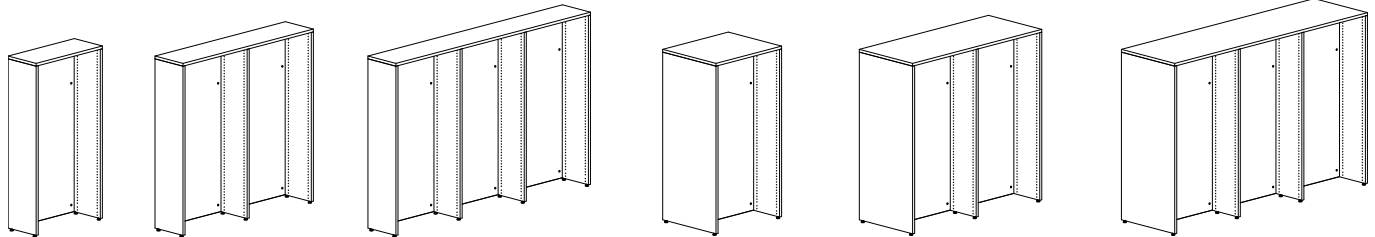

Ein-/doppelseitiges Regal - H1520 mm - 1/2/3 Sektionen

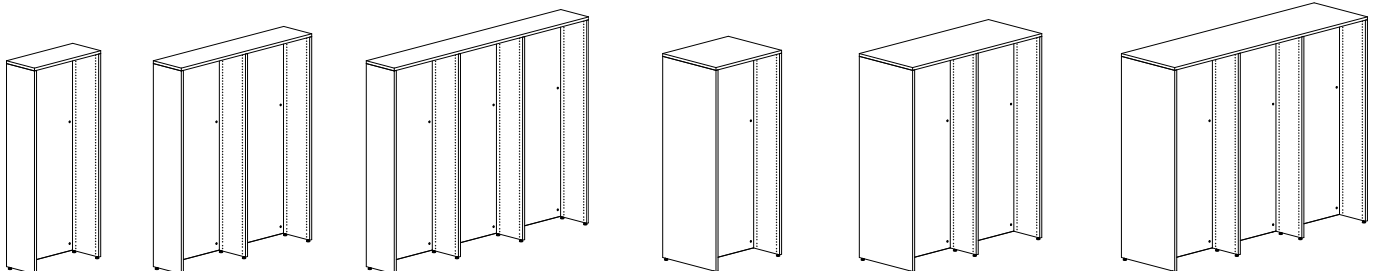

Ein-/doppelseitiges Regal - H1820 mm - 1/2/3 Sektionen

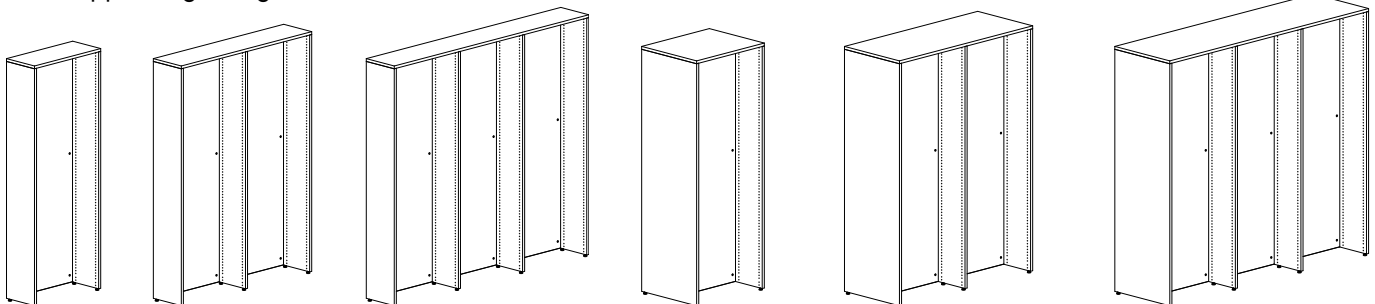

Ein-/doppelseitiges Regal - H2120 mm - 1/2/3 Sektionen

LINGO REGALSYSTEM

EINSEITIG - RÜCKWAND - STELLFÜßE - MIT HOLZABDECKPLATTE

Lackierte und furnierte Lingo Regale haben das FSC Zertifikat.

H720 mm

Achsmaß mm	FB Tiefe mm	Sektionen	Bestell-Nr.	Melamin	Lackiert	Furniert
500	250	1	BBN00223551013000.	-	-	-
500	250	2	BBN00223551023000.	-	-	-
500	250	3	BBN00223551033000.	-	-	-
500	300	1	BBN00225551013000.	-	-	-
500	300	2	BBN00225551023000.	-	-	-
500	300	3	BBN00225551033000.	-	-	-
500	400	1	BBN00227551013000.	-	-	-
500	400	2	BBN00227551023000.	-	-	-
500	400	3	BBN00227551033000.	-	-	-
750	250	1	BBN00223751013000.	-	-	-
750	250	2	BBN00223751023000.	-	-	-
750	250	3	BBN00223751033000.	-	-	-
750	300	1	BBN00225751013000.	-	-	-
750	300	2	BBN00225751023000.	-	-	-
750	300	3	BBN00225751033000.	-	-	-
750	400	1	BBN00227751013000.	-	-	-
750	400	2	BBN00227751023000.	-	-	-
750	400	3	BBN00227751033000.	-	-	-
900	250	1	BBN00223951013000.	-	-	-
900	250	2	BBN00223951023000.	-	-	-
900	300	1	BBN00225951013000.	-	-	-
900	300	2	BBN00225951023000.	-	-	-
900	400	1	BBN00227951013000.	-	-	-
900	400	2	BBN00227951023000.	-	-	-
1000	250	1	BBN00223151013000.	-	-	-
1000	250	2	BBN00223151023000.	-	-	-
1000	300	1	BBN00225151013000.	-	-	-
1000	300	2	BBN00225151023000.	-	-	-
1000	400	1	BBN00227151013000.	-	-	-
1000	400	2	BBN00227151023000.	-	-	-

LINGO REGALSYSTEM

EINSEITIG - RÜCKWAND - STELLFÜßE - MIT HOLZABDECKPLATTE

Lackierte und furnierte Lingo Regale haben das FSC Zertifikat.

H920 mm

Achsmaß mm	FB Tiefe mm	Sektionen	Bestell-Nr.	Melamin	Lackiert	Furniert
500	250	1	BBN00233551013000.	-	-	-
500	250	2	BBN00233551023000.	-	-	-
500	250	3	BBN00233551033000.	-	-	-
500	300	1	BBN00235551013000.	-	-	-
500	300	2	BBN00235551023000.	-	-	-
500	300	3	BBN00235551033000.	-	-	-
500	400	1	BBN00237551013000.	-	-	-
500	400	2	BBN00237551023000.	-	-	-
500	400	3	BBN00237551033000.	-	-	-
750	250	1	BBN00233751013000.	-	-	-
750	250	2	BBN00233751023000.	-	-	-
750	250	3	BBN00233751033000.	-	-	-
750	300	1	BBN00235751013000.	-	-	-
750	300	2	BBN00235751023000.	-	-	-
750	300	3	BBN00235751033000.	-	-	-
750	400	1	BBN00237751013000.	-	-	-
750	400	2	BBN00237751023000.	-	-	-
750	400	3	BBN00237751033000.	-	-	-
900	250	1	BBN00233951013000.	-	-	-
900	250	2	BBN00233951023000.	-	-	-
900	300	1	BBN00235951013000.	-	-	-
900	300	2	BBN00235951023000.	-	-	-
900	400	1	BBN00237951013000.	-	-	-
900	400	2	BBN00237951023000.	-	-	-
1000	250	1	BBN00233151013000.	-	-	-
1000	250	2	BBN00233151023000.	-	-	-
1000	300	1	BBN00235151013000.	-	-	-
1000	300	2	BBN00235151023000.	-	-	-
1000	400	1	BBN00237151013000.	-	-	-
1000	400	2	BBN00237151023000.	-	-	-

LINGO REGALSYSTEM

EINSEITIG - RÜCKWAND - STELLFÜßE - MIT HOLZABDECKPLATTE

Lackierte und furnierte Lingo Regale haben das FSC Zertifikat.

H1220 mm

Achsmaß mm	FB Tiefe mm	Sektionen	Bestell-Nr.	Melamin	Lackiert	Furniert
500	250	1	BBN00243551013000.	-	-	-
500	250	2	BBN00243551023000.	-	-	-
500	250	3	BBN00243551033000.	-	-	-
500	300	1	BBN00245551013000.	-	-	-
500	300	2	BBN00245551023000.	-	-	-
500	300	3	BBN00245551033000.	-	-	-
500	400	1	BBN00247551013000.	-	-	-
500	400	2	BBN00247551023000.	-	-	-
500	400	3	BBN00247551033000.	-	-	-
750	250	1	BBN00243751013000.	-	-	-
750	250	2	BBN00243751023000.	-	-	-
750	250	3	BBN00243751033000.	-	-	-
750	300	1	BBN00245751013000.	-	-	-
750	300	2	BBN00245751023000.	-	-	-
750	300	3	BBN00245751033000.	-	-	-
750	400	1	BBN00247751013000.	-	-	-
750	400	2	BBN00247751023000.	-	-	-
750	400	3	BBN00247751033000.	-	-	-
900	250	1	BBN00243951013000.	-	-	-
900	250	2	BBN00243951023000.	-	-	-
900	300	1	BBN00245951013000.	-	-	-
900	300	2	BBN00245951023000.	-	-	-
900	400	1	BBN00247951013000.	-	-	-
900	400	2	BBN00247951023000.	-	-	-
1000	250	1	BBN00243151013000.	-	-	-
1000	250	2	BBN00243151023000.	-	-	-
1000	300	1	BBN00245151013000.	-	-	-
1000	300	2	BBN00245151023000.	-	-	-
1000	400	1	BBN00247151013000.	-	-	-
1000	400	2	BBN00247151023000.	-	-	-

LINGO REGALSYSTEM

EINSEITIG - RÜCKWAND - STELLFÜßE - MIT HOLZABDECKPLATTE

Lackierte und furnierte Lingo Regale haben das FSC Zertifikat.

H1520 mm

Achsmaß mm	FB Tiefe mm	Sektionen	Bestell-Nr.	Melamin	Lackiert	Furniert
500	250	1	BBN00253551013000.	-	-	-
500	250	2	BBN00253551023000.	-	-	-
500	250	3	BBN00253551033000.	-	-	-
500	300	1	BBN00255551013000.	-	-	-
500	300	2	BBN00255551023000.	-	-	-
500	300	3	BBN00255551033000.	-	-	-
500	400	1	BBN00257551013000.	-	-	-
500	400	2	BBN00257551023000.	-	-	-
500	400	3	BBN00257551033000.	-	-	-
750	250	1	BBN00253751013000.	-	-	-
750	250	2	BBN00253751023000.	-	-	-
750	250	3	BBN00253751033000.	-	-	-
750	300	1	BBN00255751013000.	-	-	-
750	300	2	BBN00255751023000.	-	-	-
750	300	3	BBN00255751033000.	-	-	-
750	400	1	BBN00257751013000.	-	-	-
750	400	2	BBN00257751023000.	-	-	-
750	400	3	BBN00257751033000.	-	-	-
900	250	1	BBN00253951013000.	-	-	-
900	250	2	BBN00253951023000.	-	-	-
900	300	1	BBN00255951013000.	-	-	-
900	300	2	BBN00255951023000.	-	-	-
900	400	1	BBN00257951013000.	-	-	-
900	400	2	BBN00257951023000.	-	-	-
1000	250	1	BBN00253151013000.	-	-	-
1000	250	2	BBN00253151023000.	-	-	-
1000	300	1	BBN00255151013000.	-	-	-
1000	300	2	BBN00255151023000.	-	-	-
1000	400	1	BBN00257151013000.	-	-	-
1000	400	2	BBN00257151023000.	-	-	-

LINGO REGALSYSTEM

EINSEITIG - RÜCKWAND - STELLFÜßE - MIT HOLZABDECKPLATTE

Lackierte und furnierte Lingo Regale haben das FSC Zertifikat.

H1820 mm

Achsmaß mm	FB Tiefe mm	Sektionen	Bestell-Nr.	Melamin	Lackiert	Furniert
500	250	1	BBN00263551013000.	-	-	-
500	250	2	BBN00263551023000.	-	-	-
500	250	3	BBN00263551033000.	-	-	-
500	300	1	BBN00265551013000.	-	-	-
500	300	2	BBN00265551023000.	-	-	-
500	300	3	BBN00265551033000.	-	-	-
500	400	1	BBN00267551013000.	-	-	-
500	400	2	BBN00267551023000.	-	-	-
500	400	3	BBN00267551033000.	-	-	-
750	250	1	BBN00263751013000.	-	-	-
750	250	2	BBN00263751023000.	-	-	-
750	250	3	BBN00263751033000.	-	-	-
750	300	1	BBN00265751013000.	-	-	-
750	300	2	BBN00265751023000.	-	-	-
750	300	3	BBN00265751033000.	-	-	-
750	400	1	BBN00267751013000.	-	-	-
750	400	2	BBN00267751023000.	-	-	-
750	400	3	BBN00267751033000.	-	-	-
900	250	1	BBN00263951013000.	-	-	-
900	250	2	BBN00263951023000.	-	-	-
900	300	1	BBN00265951013000.	-	-	-
900	300	2	BBN00265951023000.	-	-	-
900	400	1	BBN00267951013000.	-	-	-
900	400	2	BBN00267951023000.	-	-	-
1000	250	1	BBN00263151013000.	-	-	-
1000	250	2	BBN00263151023000.	-	-	-
1000	300	1	BBN00265151013000.	-	-	-
1000	300	2	BBN00265151023000.	-	-	-
1000	400	1	BBN00267151013000.	-	-	-
1000	400	2	BBN00267151023000.	-	-	-

LINGO REGALSYSTEM

EINSEITIG - RÜCKWAND - STELLFÜßE - MIT HOLZABDECKPLATTE

Lackierte und furnierte Lingo Regale haben das FSC Zertifikat.

H2120 mm

Achsmaß mm	FB Tiefe mm	Sektionen	Bestell-Nr.	Melamin	Lackiert	Furniert
500	250	1	BBN00273551013000.	-	-	-
500	250	2	BBN00273551023000.	-	-	-
500	250	3	BBN00273551033000.	-	-	-
500	300	1	BBN00275551013000.	-	-	-
500	300	2	BBN00275551023000.	-	-	-
500	300	3	BBN00275551033000.	-	-	-
500	400	1	BBN00277551013000.	-	-	-
500	400	2	BBN00277551023000.	-	-	-
500	400	3	BBN00277551033000.	-	-	-
750	250	1	BBN00273751013000.	-	-	-
750	250	2	BBN00273751023000.	-	-	-
750	250	3	BBN00273751033000.	-	-	-
750	300	1	BBN00275751013000.	-	-	-
750	300	2	BBN00275751023000.	-	-	-
750	300	3	BBN00275751033000.	-	-	-
750	400	1	BBN00277751013000.	-	-	-
750	400	2	BBN00277751023000.	-	-	-
750	400	3	BBN00277751033000.	-	-	-
900	250	1	BBN00273951013000.	-	-	-
900	250	2	BBN00273951023000.	-	-	-
900	300	1	BBN00275951013000.	-	-	-
900	300	2	BBN00275951023000.	-	-	-
900	400	1	BBN00277951013000.	-	-	-
900	400	2	BBN00277951023000.	-	-	-
1000	250	1	BBN00273151013000.	-	-	-
1000	250	2	BBN00273151023000.	-	-	-
1000	300	1	BBN00275151013000.	-	-	-
1000	300	2	BBN00275151023000.	-	-	-
1000	400	1	BBN00277151013000.	-	-	-
1000	400	2	BBN00277151023000.	-	-	-

LINGO REGALSYSTEM

DOPPELSEITIG - RÜCKWAND - STELLFÜßE - MIT HOLZABDECKPLATTE

Lackierte und furnierte Lingo Regale haben das FSC Zertifikat.

H720 mm

Achsmaß mm	FB Tiefe mm	Sektionen	Bestell-Nr.	Melamin	Lackiert	Furniert
500	250	1	BBN00224551013000.	-	-	-
500	250	2	BBN00224551023000.	-	-	-
500	250	3	BBN00224551033000.	-	-	-
500	300	1	BBN00226551013000.	-	-	-
500	300	2	BBN00226551023000.	-	-	-
500	300	3	BBN00226551033000.	-	-	-
500	400	1	BBN00228551013000.	-	-	-
500	400	2	BBN00228551023000.	-	-	-
500	400	3	BBN00228551033000.	-	-	-
750	250	1	BBN00224751013000.	-	-	-
750	250	2	BBN00224751023000.	-	-	-
750	250	3	BBN00224751033000.	-	-	-
750	300	1	BBN00226751013000.	-	-	-
750	300	2	BBN00226751023000.	-	-	-
750	300	3	BBN00226751033000.	-	-	-
750	400	1	BBN00228751013000.	-	-	-
750	400	2	BBN00228751023000.	-	-	-
750	400	3	BBN00228751033000.	-	-	-
900	250	1	BBN00224951013000.	-	-	-
900	250	2	BBN00224951023000.	-	-	-
900	300	1	BBN00226951013000.	-	-	-
900	300	2	BBN00226951023000.	-	-	-
900	400	1	BBN00228951013000.	-	-	-
900	400	2	BBN00228951023000.	-	-	-
1000	250	1	BBN00224151013000.	-	-	-
1000	250	2	BBN00224151023000.	-	-	-
1000	300	1	BBN00226151013000.	-	-	-
1000	300	2	BBN00226151023000.	-	-	-
1000	400	1	BBN00228151013000.	-	-	-
1000	400	2	BBN00228151023000.	-	-	-

LINGO REGALSYSTEM

DOPPELSEITIG - RÜCKWAND - STELLFÜßE - MIT HOLZABDECKPLATTE

Lackierte und furnierte Lingo Regale haben das FSC Zertifikat.

H920 mm

Achsmaß mm	FB Tiefe mm	Sektionen	Bestell-Nr.	Melamin	Lackiert	Furniert
500	250	1	BBN00234551013000.	-	-	-
500	250	2	BBN00234551023000.	-	-	-
500	250	3	BBN00234551033000.	-	-	-
500	300	1	BBN00236551013000.	-	-	-
500	300	2	BBN00236551023000.	-	-	-
500	300	3	BBN00236551033000.	-	-	-
500	400	1	BBN00238551013000.	-	-	-
500	400	2	BBN00238551023000.	-	-	-
500	400	3	BBN00238551033000.	-	-	-
750	250	1	BBN00234751013000.	-	-	-
750	250	2	BBN00234751023000.	-	-	-
750	250	3	BBN00234751033000.	-	-	-
750	300	1	BBN00236751013000.	-	-	-
750	300	2	BBN00236751023000.	-	-	-
750	300	3	BBN00236751033000.	-	-	-
750	400	1	BBN00238751013000.	-	-	-
750	400	2	BBN00238751023000.	-	-	-
750	400	3	BBN00238751033000.	-	-	-
900	250	1	BBN00234951013000.	-	-	-
900	250	2	BBN00234951023000.	-	-	-
900	300	1	BBN00236951013000.	-	-	-
900	300	2	BBN00236951023000.	-	-	-
900	400	1	BBN00238951013000.	-	-	-
900	400	2	BBN00238951023000.	-	-	-
1000	250	1	BBN00234151013000.	-	-	-
1000	250	2	BBN00234151023000.	-	-	-
1000	300	1	BBN00236151013000.	-	-	-
1000	300	2	BBN00236151023000.	-	-	-
1000	400	1	BBN00238151013000.	-	-	-
1000	400	2	BBN00238151023000.	-	-	-

LINGO REGALSYSTEM

DOPPELSEITIG - RÜCKWAND - STELLFÜßE - MIT HOLZABDECKPLATTE

Lackierte und furnierte Lingo Regale haben das FSC Zertifikat.

H1220 mm

Achsmaß mm	FB Tiefe mm	Sektionen	Bestell-Nr.	Melamin	Lackiert	Furniert
500	250	1	BBN00244551013000.	-	-	-
500	250	2	BBN00244551023000.	-	-	-
500	250	3	BBN00244551033000.	-	-	-
500	300	1	BBN00246551013000.	-	-	-
500	300	2	BBN00246551023000.	-	-	-
500	300	3	BBN00246551033000.	-	-	-
500	400	1	BBN00248551013000.	-	-	-
500	400	2	BBN00248551023000.	-	-	-
500	400	3	BBN00248551033000.	-	-	-
750	250	1	BBN00244751013000.	-	-	-
750	250	2	BBN00244751023000.	-	-	-
750	250	3	BBN00244751033000.	-	-	-
750	300	1	BBN00246751013000.	-	-	-
750	300	2	BBN00246751023000.	-	-	-
750	300	3	BBN00246751033000.	-	-	-
750	400	1	BBN00248751013000.	-	-	-
750	400	2	BBN00248751023000.	-	-	-
750	400	3	BBN00248751033000.	-	-	-
900	250	1	BBN00244951013000.	-	-	-
900	250	2	BBN00244951023000.	-	-	-
900	300	1	BBN00246951013000.	-	-	-
900	300	2	BBN00246951023000.	-	-	-
900	400	1	BBN00248951013000.	-	-	-
900	400	2	BBN00248951023000.	-	-	-
1000	250	1	BBN00244151013000.	-	-	-
1000	250	2	BBN00244151023000.	-	-	-
1000	300	1	BBN00246151013000.	-	-	-
1000	300	2	BBN00246151023000.	-	-	-
1000	400	1	BBN00248151013000.	-	-	-
1000	400	2	BBN00248151023000.	-	-	-

LINGO REGALSYSTEM

DOPPELSEITIG - RÜCKWAND - STELLFÜßE - MIT HOLZABDECKPLATTE

Lackierte und furnierte Lingo Regale haben das FSC Zertifikat.

H1520 mm

Achsmaß mm	FB Tiefe mm	Sektionen	Bestell-Nr.	Melamin	Lackiert	Furniert
500	250	1	BBN00254551013000.	-	-	-
500	250	2	BBN00254551023000.	-	-	-
500	250	3	BBN00254551033000.	-	-	-
500	300	1	BBN00256551013000.	-	-	-
500	300	2	BBN00256551023000.	-	-	-
500	300	3	BBN00256551033000.	-	-	-
500	400	1	BBN00258551013000.	-	-	-
500	400	2	BBN00258551023000.	-	-	-
500	400	3	BBN00258551033000.	-	-	-
750	250	1	BBN00254751013000.	-	-	-
750	250	2	BBN00254751023000.	-	-	-
750	250	3	BBN00254751033000.	-	-	-
750	300	1	BBN00256751013000.	-	-	-
750	300	2	BBN00256751023000.	-	-	-
750	300	3	BBN00256751033000.	-	-	-
750	400	1	BBN00258751013000.	-	-	-
750	400	2	BBN00258751023000.	-	-	-
750	400	3	BBN00258751033000.	-	-	-
900	250	1	BBN00254951013000.	-	-	-
900	250	2	BBN00254951023000.	-	-	-
900	300	1	BBN00256951013000.	-	-	-
900	300	2	BBN00256951023000.	-	-	-
900	400	1	BBN00258951013000.	-	-	-
900	400	2	BBN00258951023000.	-	-	-
1000	250	1	BBN00254151013000.	-	-	-
1000	250	2	BBN00254151023000.	-	-	-
1000	300	1	BBN00256151013000.	-	-	-
1000	300	2	BBN00256151023000.	-	-	-
1000	400	1	BBN00258151013000.	-	-	-
1000	400	2	BBN00258151023000.	-	-	-

LINGO REGALSYSTEM

DOPPELSEITIG - RÜCKWAND - STELLFÜßE - MIT HOLZABDECKPLATTE

Lackierte und furnierte Lingo Regale haben das FSC Zertifikat.

H1820 mm

Achsmaß mm	FB Tiefe mm	Sektionen	Bestell-Nr.	Melamin	Lackiert	Furniert
500	250	1	BBN00264551013000.	-	-	-
500	250	2	BBN00264551023000.	-	-	-
500	250	3	BBN00264551033000.	-	-	-
500	300	1	BBN00266551013000.	-	-	-
500	300	2	BBN00266551023000.	-	-	-
500	300	3	BBN00266551033000.	-	-	-
500	400	1	BBN00268551013000.	-	-	-
500	400	2	BBN00268551023000.	-	-	-
500	400	3	BBN00268551033000.	-	-	-
750	250	1	BBN00264751013000.	-	-	-
750	250	2	BBN00264751023000.	-	-	-
750	250	3	BBN00264751033000.	-	-	-
750	300	1	BBN00266751013000.	-	-	-
750	300	2	BBN00266751023000.	-	-	-
750	300	3	BBN00266751033000.	-	-	-
750	400	1	BBN00268751013000.	-	-	-
750	400	2	BBN00268751023000.	-	-	-
750	400	3	BBN00268751033000.	-	-	-
900	250	1	BBN00264951013000.	-	-	-
900	250	2	BBN00264951023000.	-	-	-
900	300	1	BBN00266951013000.	-	-	-
900	300	2	BBN00266951023000.	-	-	-
900	400	1	BBN00268951013000.	-	-	-
900	400	2	BBN00268951023000.	-	-	-
1000	250	1	BBN00264151013000.	-	-	-
1000	250	2	BBN00264151023000.	-	-	-
1000	300	1	BBN00266151013000.	-	-	-
1000	300	2	BBN00266151023000.	-	-	-
1000	400	1	BBN00268151013000.	-	-	-
1000	400	2	BBN00268151023000.	-	-	-

LINGO REGALSYSTEM

DOPPELSEITIG - RÜCKWAND - STELLFÜßE - MIT HOLZABDECKPLATTE

Lackierte und furnierte Lingo Regale haben das FSC Zertifikat.

H2120 mm

Achsmaß mm	FB Tiefe mm	Sektionen	Bestell-Nr.	Melamin	Lackiert	Furniert
500	250	1	BBN00274551013000.	-	-	-
500	250	2	BBN00274551023000.	-	-	-
500	250	3	BBN00274551033000.	-	-	-
500	300	1	BBN00276551013000.	-	-	-
500	300	2	BBN00276551023000.	-	-	-
500	300	3	BBN00276551033000.	-	-	-
500	400	1	BBN00278551013000.	-	-	-
500	400	2	BBN00278551023000.	-	-	-
500	400	3	BBN00278551033000.	-	-	-
750	250	1	BBN00274751013000.	-	-	-
750	250	2	BBN00274751023000.	-	-	-
750	250	3	BBN00274751033000.	-	-	-
750	300	1	BBN00276751013000.	-	-	-
750	300	2	BBN00276751023000.	-	-	-
750	300	3	BBN00276751033000.	-	-	-
750	400	1	BBN00278751013000.	-	-	-
750	400	2	BBN00278751023000.	-	-	-
750	400	3	BBN00278751033000.	-	-	-
900	250	1	BBN00274951013000.	-	-	-
900	250	2	BBN00274951023000.	-	-	-
900	300	1	BBN00276951013000.	-	-	-
900	300	2	BBN00276951023000.	-	-	-
900	400	1	BBN00278951013000.	-	-	-
900	400	2	BBN00278951023000.	-	-	-
1000	250	1	BBN00274151013000.	-	-	-
1000	250	2	BBN00274151023000.	-	-	-
1000	300	1	BBN00276151013000.	-	-	-
1000	300	2	BBN00276151023000.	-	-	-
1000	400	1	BBN00278151013000.	-	-	-
1000	400	2	BBN00278151023000.	-	-	-

LINGO REGALSYSTEM

BBN002 - DIAGONALTRAVERSE - STELLFÜßE - MIT HOLZABDECKPLATTE



LINGO REGALSYSTEM

BBN002 - DIAGONALTRAVERSE - STELLFÜßE - MIT HOLZABDECKPLATTE

Regalsystem mit Holzseiten, Diagonaltraverse und überliegender Holzabdeckplatte. 1 Zwischenfachboden muß mit den Holzseiten bei Höhen über H1220 mm verschraubt werden. Für Konfigurationen mit mehr als 3 Sektionen, bitte kontaktieren Sie unsere Verkaufsabteilung.

- Preis basiert auf Metallpreisgruppe 1 und Holzpreisgruppe A (siehe Designauswahl Seiten 6-9).
- Für Fachböden siehe Seite 128.
- Für Funktionen siehe Seite 168.

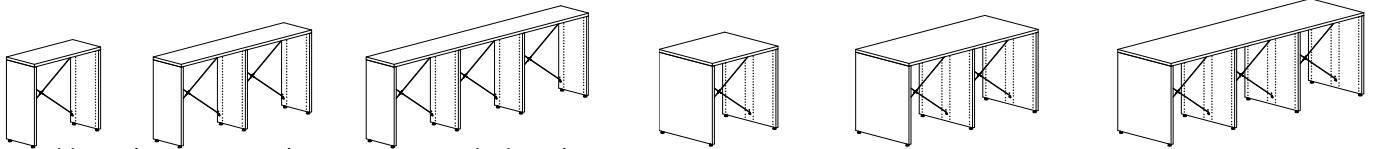

Ein-/doppelseitiges Regal - H720 mm - 1/2/3 Sektionen

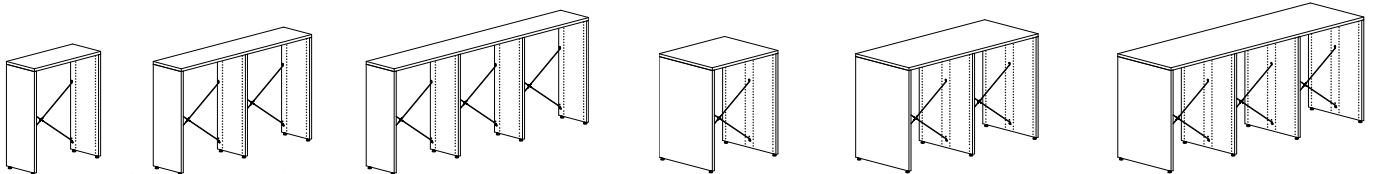

Ein-/doppelseitiges Regal - H920 mm - 1/2/3 Sektionen

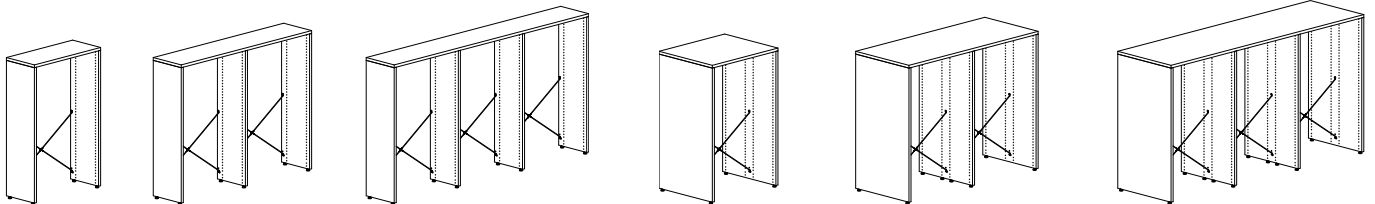

Ein-/doppelseitiges Regal - H1220 mm - 1/2/3 Sektionen

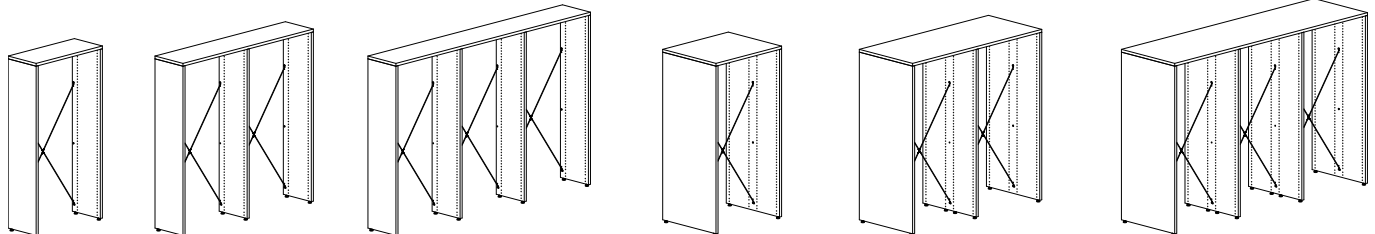

Ein-/doppelseitiges Regal - H1520 mm - 1/2/3 Sektionen

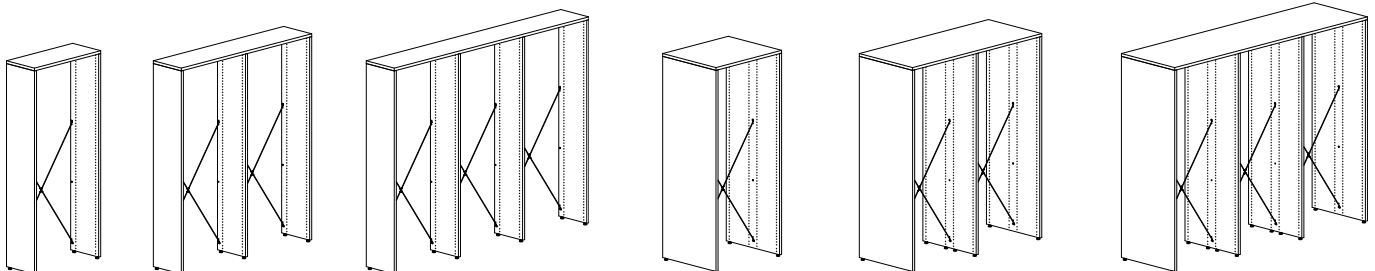

Ein-/doppelseitiges Regal - H1820 mm - 1/2/3 Sektionen

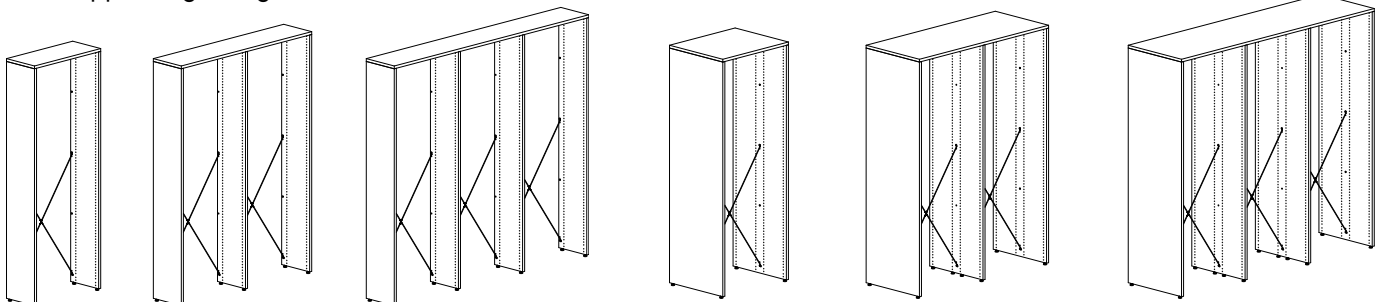

Ein-/doppelseitiges Regal - H2120 mm - 1/2/3 Sektionen

LINGO REGALSYSTEM

EINSEITIG - DIAGONALTRAVERSE - STELLFÜßE - MIT HOLZABDECKPLATTE

Lackierte und furnierte Lingo Regale haben das FSC Zertifikat.

H720 mm

Achsmaß mm	FB Tiefe mm	Sektionen	Bestell-Nr.	Melamin	Lackiert	Furniert
500	250	1	BBN00223551019000.	-	-	-
500	250	2	BBN00223551029000.	-	-	-
500	250	3	BBN00223551039000.	-	-	-
500	300	1	BBN00225551019000.	-	-	-
500	300	2	BBN00225551029000.	-	-	-
500	300	3	BBN00225551039000.	-	-	-
500	400	1	BBN00227551019000.	-	-	-
500	400	2	BBN00227551029000.	-	-	-
500	400	3	BBN00227551039000.	-	-	-
750	250	1	BBN00223751019000.	-	-	-
750	250	2	BBN00223751029000.	-	-	-
750	250	3	BBN00223751039000.	-	-	-
750	300	1	BBN00225751019000.	-	-	-
750	300	2	BBN00225751029000.	-	-	-
750	300	3	BBN00225751039000.	-	-	-
750	400	1	BBN00227751019000.	-	-	-
750	400	2	BBN00227751029000.	-	-	-
750	400	3	BBN00227751039000.	-	-	-
900	250	1	BBN00223951019000.	-	-	-
900	250	2	BBN00223951029000.	-	-	-
900	300	1	BBN00225951019000.	-	-	-
900	300	2	BBN00225951029000.	-	-	-
900	400	1	BBN00227951019000.	-	-	-
900	400	2	BBN00227951029000.	-	-	-
1000	250	1	BBN00223151019000.	-	-	-
1000	250	2	BBN00223151029000.	-	-	-
1000	300	1	BBN00225151019000.	-	-	-
1000	300	2	BBN00225151029000.	-	-	-
1000	400	1	BBN00227151019000.	-	-	-
1000	400	2	BBN00227151029000.	-	-	-

LINGO REGALSYSTEM

EINSEITIG - DIAGONALTRAVERSE - STELLFÜßE - MIT HOLZABDECKPLATTE

Lackierte und furnierte Lingo Regale haben das FSC Zertifikat.

H920 mm

Achsmaß mm	FB Tiefe mm	Sektionen	Bestell-Nr.	Melamin	Lackiert	Furniert
500	250	1	BBN00233551019000.	-	-	-
500	250	2	BBN00233551029000.	-	-	-
500	250	3	BBN00233551039000.	-	-	-
500	300	1	BBN00235551019000.	-	-	-
500	300	2	BBN00235551029000.	-	-	-
500	300	3	BBN00235551039000.	-	-	-
500	400	1	BBN00237551019000.	-	-	-
500	400	2	BBN00237551029000.	-	-	-
500	400	3	BBN00237551039000.	-	-	-
750	250	1	BBN00233751019000.	-	-	-
750	250	2	BBN00233751029000.	-	-	-
750	250	3	BBN00233751039000.	-	-	-
750	300	1	BBN00235751019000.	-	-	-
750	300	2	BBN00235751029000.	-	-	-
750	300	3	BBN00235751039000.	-	-	-
750	400	1	BBN00237751019000.	-	-	-
750	400	2	BBN00237751029000.	-	-	-
750	400	3	BBN00237751039000.	-	-	-
900	250	1	BBN00233951019000.	-	-	-
900	250	2	BBN00233951029000.	-	-	-
900	300	1	BBN00235951019000.	-	-	-
900	300	2	BBN00235951029000.	-	-	-
900	400	1	BBN00237951019000.	-	-	-
900	400	2	BBN00237951029000.	-	-	-
1000	250	1	BBN00233151019000.	-	-	-
1000	250	2	BBN00233151029000.	-	-	-
1000	300	1	BBN00235151019000.	-	-	-
1000	300	2	BBN00235151029000.	-	-	-
1000	400	1	BBN00237151019000.	-	-	-
1000	400	2	BBN00237151029000.	-	-	-

LINGO REGALSYSTEM

EINSEITIG - DIAGONALTRAVERSE - STELFÜßE - MIT HOLZABDECKPLATTE

Lackierte und furnierte Lingo Regale haben das FSC Zertifikat.

H1220 mm

Achsmaß mm	FB Tiefe mm	Sektionen	Bestell-Nr.	Melamin	Lackiert	Furniert
500	250	1	BBN00243551019000.	-	-	-
500	250	2	BBN00243551029000.	-	-	-
500	250	3	BBN00243551039000.	-	-	-
500	300	1	BBN00245551019000.	-	-	-
500	300	2	BBN00245551029000.	-	-	-
500	300	3	BBN00245551039000.	-	-	-
500	400	1	BBN00247551019000.	-	-	-
500	400	2	BBN00247551029000.	-	-	-
500	400	3	BBN00247551039000.	-	-	-
750	250	1	BBN00243751019000.	-	-	-
750	250	2	BBN00243751029000.	-	-	-
750	250	3	BBN00243751039000.	-	-	-
750	300	1	BBN00245751019000.	-	-	-
750	300	2	BBN00245751029000.	-	-	-
750	300	3	BBN00245751039000.	-	-	-
750	400	1	BBN00247751019000.	-	-	-
750	400	2	BBN00247751029000.	-	-	-
750	400	3	BBN00247751039000.	-	-	-
900	250	1	BBN00243951019000.	-	-	-
900	250	2	BBN00243951029000.	-	-	-
900	300	1	BBN00245951019000.	-	-	-
900	300	2	BBN00245951029000.	-	-	-
900	400	1	BBN00247951019000.	-	-	-
900	400	2	BBN00247951029000.	-	-	-
1000	250	1	BBN00243151019000.	-	-	-
1000	250	2	BBN00243151029000.	-	-	-
1000	300	1	BBN00245151019000.	-	-	-
1000	300	2	BBN00245151029000.	-	-	-
1000	400	1	BBN00247151019000.	-	-	-
1000	400	2	BBN00247151029000.	-	-	-

LINGO REGALSYSTEM

EINSEITIG - DIAGONALTRAVERSE - STELLFÜßE - MIT HOLZABDECKPLATTE

Lackierte und furnierte Lingo Regale haben das FSC Zertifikat.

H1520 mm

Achsmaß mm	FB Tiefe mm	Sektionen	Bestell-Nr.	Melamin	Lackiert	Furniert
500	250	1	BBN00253551019000.	-	-	-
500	250	2	BBN00253551029000.	-	-	-
500	250	3	BBN00253551039000.	-	-	-
500	300	1	BBN00255551019000.	-	-	-
500	300	2	BBN00255551029000.	-	-	-
500	300	3	BBN00255551039000.	-	-	-
500	400	1	BBN00257551019000.	-	-	-
500	400	2	BBN00257551029000.	-	-	-
500	400	3	BBN00257551039000.	-	-	-
750	250	1	BBN00253751019000.	-	-	-
750	250	2	BBN00253751029000.	-	-	-
750	250	3	BBN00253751039000.	-	-	-
750	300	1	BBN00255751019000.	-	-	-
750	300	2	BBN00255751029000.	-	-	-
750	300	3	BBN00255751039000.	-	-	-
750	400	1	BBN00257751019000.	-	-	-
750	400	2	BBN00257751029000.	-	-	-
750	400	3	BBN00257751039000.	-	-	-
900	250	1	BBN00253951019000.	-	-	-
900	250	2	BBN00253951029000.	-	-	-
900	300	1	BBN00255951019000.	-	-	-
900	300	2	BBN00255951029000.	-	-	-
900	400	1	BBN00257951019000.	-	-	-
900	400	2	BBN00257951029000.	-	-	-
1000	250	1	BBN00253151019000.	-	-	-
1000	250	2	BBN00253151029000.	-	-	-
1000	300	1	BBN00255151019000.	-	-	-
1000	300	2	BBN00255151029000.	-	-	-
1000	400	1	BBN00257151019000.	-	-	-
1000	400	2	BBN00257151029000.	-	-	-

LINGO REGALSYSTEM

EINSEITIG - DIAGONALTRAVERSE - STELLFÜßE - MIT HOLZABDECKPLATTE

Lackierte und furnierte Lingo Regale haben das FSC Zertifikat.

H1820 mm

Achsmaß mm	FB Tiefe mm	Sektionen	Bestell-Nr.	Melamin	Lackiert	Furniert
500	250	1	BBN00263551019000.	-	-	-
500	250	2	BBN00263551029000.	-	-	-
500	250	3	BBN00263551039000.	-	-	-
500	300	1	BBN00265551019000.	-	-	-
500	300	2	BBN00265551029000.	-	-	-
500	300	3	BBN00265551039000.	-	-	-
500	400	1	BBN00267551019000.	-	-	-
500	400	2	BBN00267551029000.	-	-	-
500	400	3	BBN00267551039000.	-	-	-
750	250	1	BBN00263751019000.	-	-	-
750	250	2	BBN00263751029000.	-	-	-
750	250	3	BBN00263751039000.	-	-	-
750	300	1	BBN00265751019000.	-	-	-
750	300	2	BBN00265751029000.	-	-	-
750	300	3	BBN00265751039000.	-	-	-
750	400	1	BBN00267751019000.	-	-	-
750	400	2	BBN00267751029000.	-	-	-
750	400	3	BBN00267751039000.	-	-	-
900	250	1	BBN00263951019000.	-	-	-
900	250	2	BBN00263951029000.	-	-	-
900	300	1	BBN00265951019000.	-	-	-
900	300	2	BBN00265951029000.	-	-	-
900	400	1	BBN00267951019000.	-	-	-
900	400	2	BBN00267951029000.	-	-	-
1000	250	1	BBN00263151019000.	-	-	-
1000	250	2	BBN00263151029000.	-	-	-
1000	300	1	BBN00265151019000.	-	-	-
1000	300	2	BBN00265151029000.	-	-	-
1000	400	1	BBN00267151019000.	-	-	-
1000	400	2	BBN00267151029000.	-	-	-

LINGO REGALSYSTEM

EINSEITIG - DIAGONALTRAVERSE - STELLFÜßE - MIT HOLZABDECKPLATTE

Lackierte und furnierte Lingo Regale haben das FSC Zertifikat.

H2120 mm

Achsmaß mm	FB Tiefe mm	Sektionen	Bestell-Nr.	Melamin	Lackiert	Furniert
500	250	1	BBN00273551019000.	-	-	-
500	250	2	BBN00273551029000.	-	-	-
500	250	3	BBN00273551039000.	-	-	-
500	300	1	BBN00275551019000.	-	-	-
500	300	2	BBN00275551029000.	-	-	-
500	300	3	BBN00275551039000.	-	-	-
500	400	1	BBN00277551019000.	-	-	-
500	400	2	BBN00277551029000.	-	-	-
500	400	3	BBN00277551039000.	-	-	-
750	250	1	BBN00273751019000.	-	-	-
750	250	2	BBN00273751029000.	-	-	-
750	250	3	BBN00273751039000.	-	-	-
750	300	1	BBN00275751019000.	-	-	-
750	300	2	BBN00275751029000.	-	-	-
750	300	3	BBN00275751039000.	-	-	-
750	400	1	BBN00277751019000.	-	-	-
750	400	2	BBN00277751029000.	-	-	-
750	400	3	BBN00277751039000.	-	-	-
900	250	1	BBN00273951019000.	-	-	-
900	250	2	BBN00273951029000.	-	-	-
900	300	1	BBN00275951019000.	-	-	-
900	300	2	BBN00275951029000.	-	-	-
900	400	1	BBN00277951019000.	-	-	-
900	400	2	BBN00277951029000.	-	-	-
1000	250	1	BBN00273151019000.	-	-	-
1000	250	2	BBN00273151029000.	-	-	-
1000	300	1	BBN00275151019000.	-	-	-
1000	300	2	BBN00275151029000.	-	-	-
1000	400	1	BBN00277151019000.	-	-	-
1000	400	2	BBN00277151029000.	-	-	-

LINGO REGALSYSTEM

DOPPELSEITIG - DIAGONALTRAVERSE - STELLFÜßE - MIT HOLZABDECKPLATTE

Lackierte und furnierte Lingo Regale haben das FSC Zertifikat.

H720 mm

Achsmaß mm	FB Tiefe mm	Sektionen	Bestell-Nr.	Melamin	Lackiert	Furniert
500	250	1	BBN00224551019000.	-	-	-
500	250	2	BBN00224551029000.	-	-	-
500	250	3	BBN00224551039000.	-	-	-
500	300	1	BBN00226551019000.	-	-	-
500	300	2	BBN00226551029000.	-	-	-
500	300	3	BBN00226551039000.	-	-	-
500	400	1	BBN00228551019000.	-	-	-
500	400	2	BBN00228551029000.	-	-	-
500	400	3	BBN00228551039000.	-	-	-
750	250	1	BBN00224751019000.	-	-	-
750	250	2	BBN00224751029000.	-	-	-
750	250	3	BBN00224751039000.	-	-	-
750	300	1	BBN00226751019000.	-	-	-
750	300	2	BBN00226751029000.	-	-	-
750	300	3	BBN00226751039000.	-	-	-
750	400	1	BBN00228751019000.	-	-	-
750	400	2	BBN00228751029000.	-	-	-
750	400	3	BBN00228751039000.	-	-	-
900	250	1	BBN00224951019000.	-	-	-
900	250	2	BBN00224951029000.	-	-	-
900	300	1	BBN00226951019000.	-	-	-
900	300	2	BBN00226951029000.	-	-	-
900	400	1	BBN00228951019000.	-	-	-
900	400	2	BBN00228951029000.	-	-	-
1000	250	1	BBN00224151019000.	-	-	-
1000	250	2	BBN00224151029000.	-	-	-
1000	300	1	BBN00226151019000.	-	-	-
1000	300	2	BBN00226151029000.	-	-	-
1000	400	1	BBN00228151019000.	-	-	-
1000	400	2	BBN00228151029000.	-	-	-

LINGO REGALSYSTEM

DOPPELSEITIG - DIAGONALTRAVERSE - STELLFÜßE - MIT HOLZABDECKPLATTE

Lackierte und furnierte Lingo Regale haben das FSC Zertifikat.

H920 mm

Achsmaß mm	FB Tiefe mm	Sektionen	Bestell-Nr.	Melamin	Lackiert	Furniert
500	250	1	BBN00234551019000.	-	-	-
500	250	2	BBN00234551029000.	-	-	-
500	250	3	BBN00234551039000.	-	-	-
500	300	1	BBN00236551019000.	-	-	-
500	300	2	BBN00236551029000.	-	-	-
500	300	3	BBN00236551039000.	-	-	-
500	400	1	BBN00238551019000.	-	-	-
500	400	2	BBN00238551029000.	-	-	-
500	400	3	BBN00238551039000.	-	-	-
750	250	1	BBN00234751019000.	-	-	-
750	250	2	BBN00234751029000.	-	-	-
750	250	3	BBN00234751039000.	-	-	-
750	300	1	BBN00236751019000.	-	-	-
750	300	2	BBN00236751029000.	-	-	-
750	300	3	BBN00236751039000.	-	-	-
750	400	1	BBN00238751019000.	-	-	-
750	400	2	BBN00238751029000.	-	-	-
750	400	3	BBN00238751039000.	-	-	-
900	250	1	BBN00234951019000.	-	-	-
900	250	2	BBN00234951029000.	-	-	-
900	300	1	BBN00236951019000.	-	-	-
900	300	2	BBN00236951029000.	-	-	-
900	400	1	BBN00238951019000.	-	-	-
900	400	2	BBN00238951029000.	-	-	-
1000	250	1	BBN00234151019000.	-	-	-
1000	250	2	BBN00234151029000.	-	-	-
1000	300	1	BBN00236151019000.	-	-	-
1000	300	2	BBN00236151029000.	-	-	-
1000	400	1	BBN00238151019000.	-	-	-
1000	400	2	BBN00238151029000.	-	-	-

LINGO REGALSYSTEM

DOPPELSEITIG - DIAGONALTRAVERSE - STELLFÜßE - MIT HOLZABDECKPLATTE

Lackierte und furnierte Lingo Regale haben das FSC Zertifikat.

H1220 mm

Achsmaß mm	FB Tiefe mm	Sektionen	Bestell-Nr.	Melamin	Lackiert	Furniert
500	250	1	BBN00244551019000.	-	-	-
500	250	2	BBN00244551029000.	-	-	-
500	250	3	BBN00244551039000.	-	-	-
500	300	1	BBN00246551019000.	-	-	-
500	300	2	BBN00246551029000.	-	-	-
500	300	3	BBN00246551039000.	-	-	-
500	400	1	BBN00248551019000.	-	-	-
500	400	2	BBN00248551029000.	-	-	-
500	400	3	BBN00248551039000.	-	-	-
750	250	1	BBN00244751019000.	-	-	-
750	250	2	BBN00244751029000.	-	-	-
750	250	3	BBN00244751039000.	-	-	-
750	300	1	BBN00246751019000.	-	-	-
750	300	2	BBN00246751029000.	-	-	-
750	300	3	BBN00246751039000.	-	-	-
750	400	1	BBN00248751019000.	-	-	-
750	400	2	BBN00248751029000.	-	-	-
750	400	3	BBN00248751039000.	-	-	-
900	250	1	BBN00244951019000.	-	-	-
900	250	2	BBN00244951029000.	-	-	-
900	300	1	BBN00246951019000.	-	-	-
900	300	2	BBN00246951029000.	-	-	-
900	400	1	BBN00248951019000.	-	-	-
900	400	2	BBN00248951029000.	-	-	-
1000	250	1	BBN00244151019000.	-	-	-
1000	250	2	BBN00244151029000.	-	-	-
1000	300	1	BBN00246151019000.	-	-	-
1000	300	2	BBN00246151029000.	-	-	-
1000	400	1	BBN00248151019000.	-	-	-
1000	400	2	BBN00248151029000.	-	-	-

LINGO REGALSYSTEM

DOPPELSEITIG - DIAGONALTRAVERSE - STELLFÜßE - MIT HOLZABDECKPLATTE

Lackierte und furnierte Lingo Regale haben das FSC Zertifikat.

H1520 mm

Achsmaß mm	FB Tiefe mm	Sektionen	Bestell-Nr.	Melamin	Lackiert	Furniert
500	250	1	BBN00254551019000.	-	-	-
500	250	2	BBN00254551029000.	-	-	-
500	250	3	BBN00254551039000.	-	-	-
500	300	1	BBN00256551019000.	-	-	-
500	300	2	BBN00256551029000.	-	-	-
500	300	3	BBN00256551039000.	-	-	-
500	400	1	BBN00258551019000.	-	-	-
500	400	2	BBN00258551029000.	-	-	-
500	400	3	BBN00258551039000.	-	-	-
750	250	1	BBN00254751019000.	-	-	-
750	250	2	BBN00254751029000.	-	-	-
750	250	3	BBN00254751039000.	-	-	-
750	300	1	BBN00256751019000.	-	-	-
750	300	2	BBN00256751029000.	-	-	-
750	300	3	BBN00256751039000.	-	-	-
750	400	1	BBN00258751019000.	-	-	-
750	400	2	BBN00258751029000.	-	-	-
750	400	3	BBN00258751039000.	-	-	-
900	250	1	BBN00254951019000.	-	-	-
900	250	2	BBN00254951029000.	-	-	-
900	300	1	BBN00256951019000.	-	-	-
900	300	2	BBN00256951029000.	-	-	-
900	400	1	BBN00258951019000.	-	-	-
900	400	2	BBN00258951029000.	-	-	-
1000	250	1	BBN00254151019000.	-	-	-
1000	250	2	BBN00254151029000.	-	-	-
1000	300	1	BBN00256151019000.	-	-	-
1000	300	2	BBN00256151029000.	-	-	-
1000	400	1	BBN00258151019000.	-	-	-
1000	400	2	BBN00258151029000.	-	-	-

LINGO REGALSYSTEM

DOPPELSEITIG - DIAGONALTRAVERSE - STELLFÜßE - MIT HOLZABDECKPLATTE

Lackierte und furnierte Lingo Regale haben das FSC Zertifikat.

H1820 mm

Achsmaß mm	FB Tiefe mm	Sektionen	Bestell-Nr.	Melamin	Lackiert	Furniert
500	250	1	BBN00264551019000.	-	-	-
500	250	2	BBN00264551029000.	-	-	-
500	250	3	BBN00264551039000.	-	-	-
500	300	1	BBN00266551019000.	-	-	-
500	300	2	BBN00266551029000.	-	-	-
500	300	3	BBN00266551039000.	-	-	-
500	400	1	BBN00268551019000.	-	-	-
500	400	2	BBN00268551029000.	-	-	-
500	400	3	BBN00268551039000.	-	-	-
750	250	1	BBN00264751019000.	-	-	-
750	250	2	BBN00264751029000.	-	-	-
750	250	3	BBN00264751039000.	-	-	-
750	300	1	BBN00266751019000.	-	-	-
750	300	2	BBN00266751029000.	-	-	-
750	300	3	BBN00266751039000.	-	-	-
750	400	1	BBN00268751019000.	-	-	-
750	400	2	BBN00268751029000.	-	-	-
750	400	3	BBN00268751039000.	-	-	-
900	250	1	BBN00264951019000.	-	-	-
900	250	2	BBN00264951029000.	-	-	-
900	300	1	BBN00266951019000.	-	-	-
900	300	2	BBN00266951029000.	-	-	-
900	400	1	BBN00268951019000.	-	-	-
900	400	2	BBN00268951029000.	-	-	-
1000	250	1	BBN00264151019000.	-	-	-
1000	250	2	BBN00264151029000.	-	-	-
1000	300	1	BBN00266151019000.	-	-	-
1000	300	2	BBN00266151029000.	-	-	-
1000	400	1	BBN00268151019000.	-	-	-
1000	400	2	BBN00268151029000.	-	-	-

LINGO REGALSYSTEM

DOPPELSEITIG - DIAGONALTRAVERSE - STELLFÜßE - MIT HOLZABDECKPLATTE

Lackierte und furnierte Lingo Regale haben das FSC Zertifikat.

H2120 mm

Achsmaß mm	FB Tiefe mm	Sektionen	Bestell-Nr.	Melamin	Lackiert	Furniert
500	250	1	BBN00274551019000.	-	-	-
500	250	2	BBN00274551029000.	-	-	-
500	250	3	BBN00274551039000.	-	-	-
500	300	1	BBN00276551019000.	-	-	-
500	300	2	BBN00276551029000.	-	-	-
500	300	3	BBN00276551039000.	-	-	-
500	400	1	BBN00278551019000.	-	-	-
500	400	2	BBN00278551029000.	-	-	-
500	400	3	BBN00278551039000.	-	-	-
750	250	1	BBN00274751019000.	-	-	-
750	250	2	BBN00274751029000.	-	-	-
750	250	3	BBN00274751039000.	-	-	-
750	300	1	BBN00276751019000.	-	-	-
750	300	2	BBN00276751029000.	-	-	-
750	300	3	BBN00276751039000.	-	-	-
750	400	1	BBN00278751019000.	-	-	-
750	400	2	BBN00278751029000.	-	-	-
750	400	3	BBN00278751039000.	-	-	-
900	250	1	BBN00274951019000.	-	-	-
900	250	2	BBN00274951029000.	-	-	-
900	300	1	BBN00276951019000.	-	-	-
900	300	2	BBN00276951029000.	-	-	-
900	400	1	BBN00278951019000.	-	-	-
900	400	2	BBN00278951029000.	-	-	-
1000	250	1	BBN00274151019000.	-	-	-
1000	250	2	BBN00274151029000.	-	-	-
1000	300	1	BBN00276151019000.	-	-	-
1000	300	2	BBN00276151029000.	-	-	-
1000	400	1	BBN00278151019000.	-	-	-
1000	400	2	BBN00278151029000.	-	-	-

LINGO REGALSYSTEM

BBN011 - RAHMEN-TRAVERSE - ROLLENPLATTE - FÜR ABDECKFACHBODEN



LINGO REGALSYSTEM

BBN011 - RAHMEN-TRAVERSE - ROLLENPLATTE - FÜR ABDECKFACHBODEN

Regalsystem mit Holzseiten, Metallrahmen-traverse und Rollenplatte. Zur Verwendung mit Abdeckböden.

- Preis basiert auf Metallpreisgruppe 1 und Holzpreisgruppe A (siehe Designauswahl Seiten 6-9).
- Für Fachböden siehe Seite 128.
- Für Funktionen siehe Seite 168.

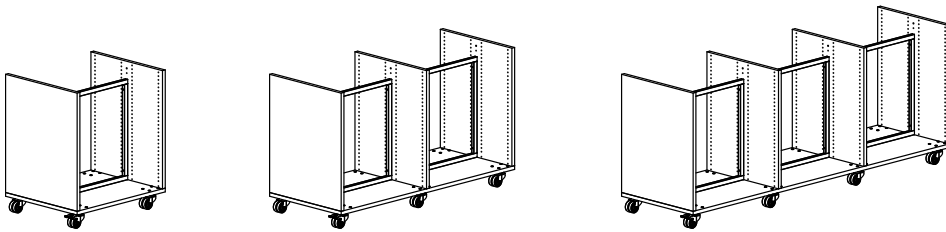

Doppelseitiges Regal - H920 mm - 1/2/3 Sektionen

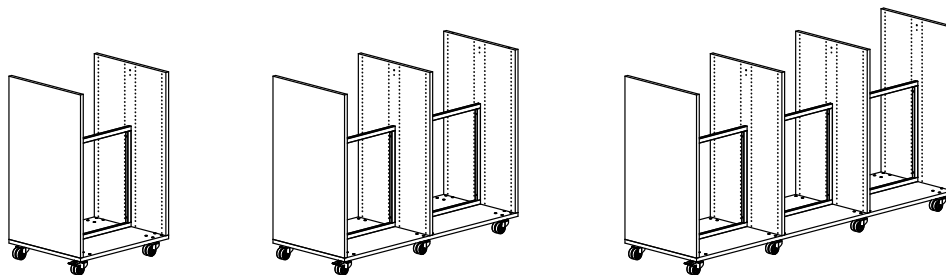

Doppelseitiges Regal - H1220 mm - 1/2/3 Sektionen

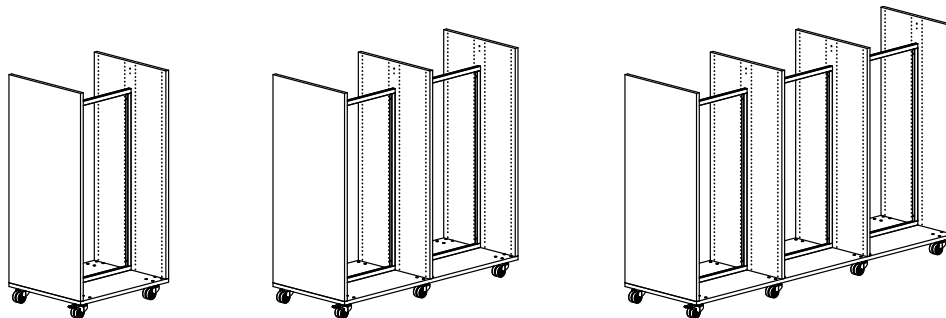

Doppelseitiges Regal - H1520 mm - 1/2/3 Sektionen

LINGO REGALSYSTEM

DOPPELSEITIG -RAHMENTRAVERSE - ROLLENPLATTE - FÜR ABDECKFACHBODEN

Lackierte und furnierte Lingo Regale haben das FSC Zertifikat.

H920 mm

Achsmaß mm	FB Tiefe mm	Sektionen	Bestell-Nr.	Melamin	Lackiert	Furniert
500	250	1	BBN011345016000.	-	-	-
500	250	2	BBN011345026000.	-	-	-
500	250	3	BBN011345036000.	-	-	-
500	300	1	BBN011365016000.	-	-	-
500	300	2	BBN011365026000.	-	-	-
500	300	3	BBN011365036000.	-	-	-
500	400	1	BBN011385016000.	-	-	-
500	400	2	BBN011385026000.	-	-	-
500	400	3	BBN011385036000.	-	-	-
750	250	1	BBN011347016000.	-	-	-
750	250	2	BBN011347026000.	-	-	-
750	250	3	BBN011347036000.	-	-	-
750	300	1	BBN011367016000.	-	-	-
750	300	2	BBN011367026000.	-	-	-
750	300	3	BBN011367036000.	-	-	-
750	400	1	BBN011387016000.	-	-	-
750	400	2	BBN011387026000.	-	-	-
750	400	3	BBN011387036000.	-	-	-
900	250	1	BBN011349016000.	-	-	-
900	250	2	BBN011349026000.	-	-	-
900	300	1	BBN011369016000.	-	-	-
900	300	2	BBN011369026000.	-	-	-
900	400	1	BBN011389016000.	-	-	-
900	400	2	BBN011389026000.	-	-	-
1000	250	1	BBN011341016000.	-	-	-
1000	250	2	BBN011341026000.	-	-	-
1000	300	1	BBN011361016000.	-	-	-
1000	300	2	BBN011361026000.	-	-	-
1000	400	1	BBN011381016000.	-	-	-
1000	400	2	BBN011381026000.	-	-	-

LINGO REGALSYSTEM

DOPPELSEITIG -RAHMENTRAVERSE - ROLLENPLATTE - FÜR ABDECKFACHBODEN

Lackierte und furnierte Lingo Regale haben das FSC Zertifikat.

H120 mm

Achsmaß mm	FB Tiefe mm	Sektionen	Bestell-Nr.	Melamin	Lackiert	Furniert
500	250	1	BBN011445016000.	-	-	-
500	250	2	BBN011445026000.	-	-	-
500	250	3	BBN011445036000.	-	-	-
500	300	1	BBN011465016000.	-	-	-
500	300	2	BBN011465026000.	-	-	-
500	300	3	BBN011465036000.	-	-	-
500	400	1	BBN011485016000.	-	-	-
500	400	2	BBN011485026000.	-	-	-
500	400	3	BBN011485036000.	-	-	-
750	250	1	BBN011447016000.	-	-	-
750	250	2	BBN011447026000.	-	-	-
750	250	3	BBN011447036000.	-	-	-
750	300	1	BBN011467016000.	-	-	-
750	300	2	BBN011467026000.	-	-	-
750	300	3	BBN011467036000.	-	-	-
750	400	1	BBN011487016000.	-	-	-
750	400	2	BBN011487026000.	-	-	-
750	400	3	BBN011487036000.	-	-	-
900	250	1	BBN011449016000.	-	-	-
900	250	2	BBN011449026000.	-	-	-
900	300	1	BBN011469016000.	-	-	-
900	300	2	BBN011469026000.	-	-	-
900	400	1	BBN011489016000.	-	-	-
900	400	2	BBN011489026000.	-	-	-
1000	250	1	BBN011441016000.	-	-	-
1000	250	2	BBN011441026000.	-	-	-
1000	300	1	BBN011461016000.	-	-	-
1000	300	2	BBN011461026000.	-	-	-
1000	400	1	BBN011481016000.	-	-	-
1000	400	2	BBN011481026000.	-	-	-

LINGO REGALSYSTEM

DOPPELSEITIG -RAHMENTRAVERSE - ROLLENPLATTE - FÜR ABDECKFACHBODEN

Lackierte und furnierte Lingo Regale haben das FSC Zertifikat.

H1520 mm

Achsmaß mm	FB Tiefe mm	Sektionen	Bestell-Nr.	Melamin	Lackiert	Furniert
500	250	1	BBN011545016000.	-	-	-
500	250	2	BBN011545026000.	-	-	-
500	250	3	BBN011545036000.	-	-	-
500	300	1	BBN011565016000.	-	-	-
500	300	2	BBN011565026000.	-	-	-
500	300	3	BBN011565036000.	-	-	-
500	400	1	BBN011585016000.	-	-	-
500	400	2	BBN011585026000.	-	-	-
500	400	3	BBN011585036000.	-	-	-
750	250	1	BBN011547016000.	-	-	-
750	250	2	BBN011547026000.	-	-	-
750	250	3	BBN011547036000.	-	-	-
750	300	1	BBN011567016000.	-	-	-
750	300	2	BBN011567026000.	-	-	-
750	300	3	BBN011567036000.	-	-	-
750	400	1	BBN011587016000.	-	-	-
750	400	2	BBN011587026000.	-	-	-
750	400	3	BBN011587036000.	-	-	-
900	250	1	BBN011549016000.	-	-	-
900	250	2	BBN011549026000.	-	-	-
900	300	1	BBN011569016000.	-	-	-
900	300	2	BBN011569026000.	-	-	-
900	400	1	BBN011589016000.	-	-	-
900	400	2	BBN011589026000.	-	-	-
1000	250	1	BBN011541016000.	-	-	-
1000	250	2	BBN011541026000.	-	-	-
1000	300	1	BBN011561016000.	-	-	-
1000	300	2	BBN011561026000.	-	-	-
1000	400	1	BBN011581016000.	-	-	-
1000	400	2	BBN011581026000.	-	-	-



LINGO REGALSYSTEM

BBN011 - HOCH RÜCKWAND - ROLLENPLATTE - FÜR ABDECKFACHBODEN



LINGO REGALSYSTEM

BBN011 - HOCH RÜCKWAND - ROLLENPLATTE - FÜR ABDECKFACHBODEN

Regalsystem mit Holzseiten, Holzrückwand und Rollenplatte. Zur Verwendung mit ST1 Standardtiefe, ST1 doppelseitig, ST2, ST3 und WT1 Standardtiefe Abdeckfachboden.

- Preis basiert auf Metallpreisgruppe 1 und Holzpreisgruppe A (siehe Designauswahl Seiten 6-9).
- Für Fachböden siehe Seite 128.
- Für Funktionen siehe Seite 168.

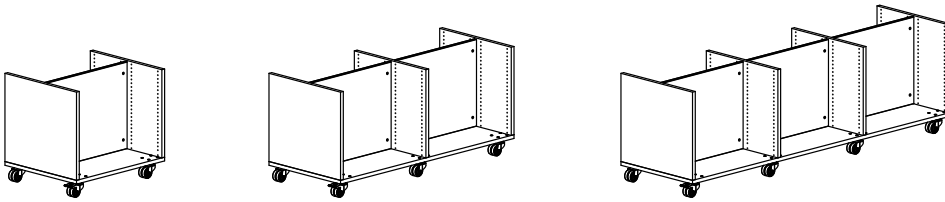

Doppelseitiges Regal - H720 mm - 1/2/3 Sektionen

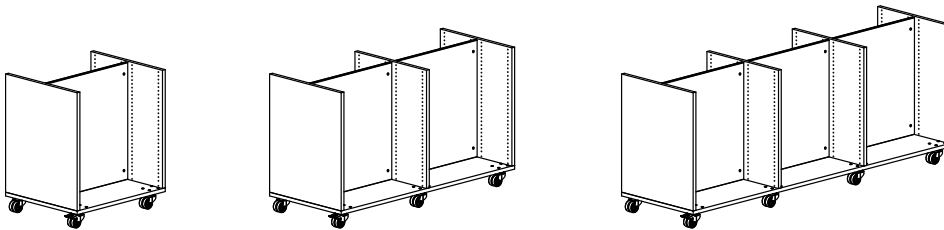

Doppelseitiges Regal - H920 mm - 1/2/3 Sektionen

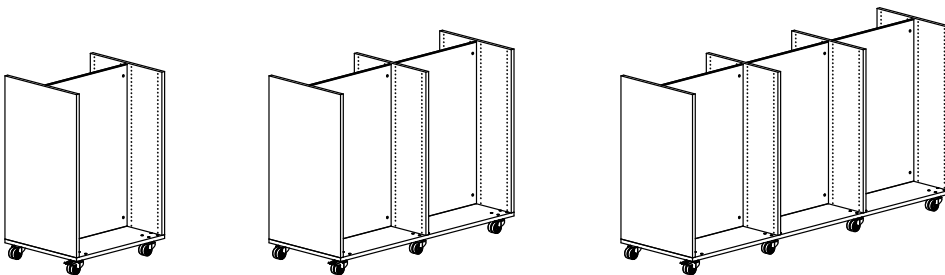

Doppelseitiges Regal - H1220 mm - 1/2/3 Sektionen

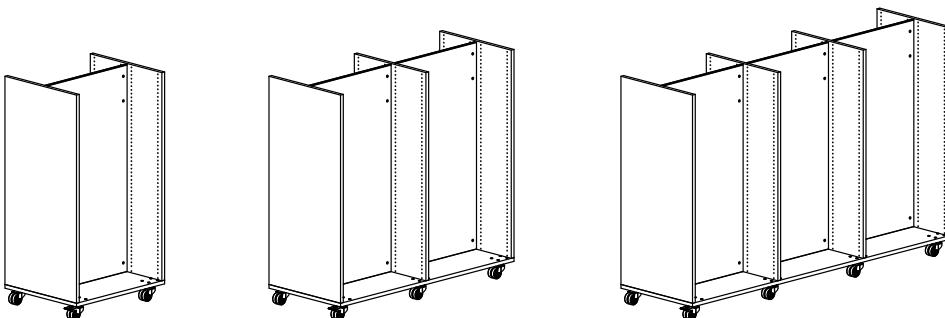

Doppelseitiges Regal - H1520 mm - 1/2/3 Sektionen

LINGO REGALSYSTEM

DOPPELSEITIG - HOCH RÜCKWAND - ROLLENPLATTE - FÜR ABDECKFACHBODEN

Lackierte und furnierte Lingo Regale haben das FSC Zertifikat.

H720 mm

Achsmaß mm	FB Tiefe mm	Sektionen	Bestell-Nr.	Melamin	Lackiert	Furniert
500	250	1	BBN0112450120006	-	-	-
500	250	2	BBN0112450220006	-	-	-
500	250	3	BBN0112450320006	-	-	-
500	300	1	BBN0112650120006	-	-	-
500	300	2	BBN0112650220006	-	-	-
500	300	3	BBN0112650320006	-	-	-
500	400	1	BBN0112850120006	-	-	-
500	400	2	BBN0112850220006	-	-	-
500	400	3	BBN0112850320006	-	-	-
750	250	1	BBN0112470120006	-	-	-
750	250	2	BBN0112470220006	-	-	-
750	250	3	BBN0112470320006	-	-	-
750	300	1	BBN0112670120006	-	-	-
750	300	2	BBN0112670220006	-	-	-
750	300	3	BBN0112670320006	-	-	-
750	400	1	BBN0112870120006	-	-	-
750	400	2	BBN0112870220006	-	-	-
750	400	3	BBN0112870320006	-	-	-
900	250	1	BBN0112490120006	-	-	-
900	250	2	BBN0112490220006	-	-	-
900	300	1	BBN0112690120006	-	-	-
900	300	2	BBN0112690220006	-	-	-
900	400	1	BBN0112890120006	-	-	-
900	400	2	BBN0112890220006	-	-	-
1000	250	1	BBN0112410120006	-	-	-
1000	250	2	BBN0112410220006	-	-	-
1000	300	1	BBN0112610120006	-	-	-
1000	300	2	BBN0112610220006	-	-	-
1000	400	1	BBN0112810120006	-	-	-
1000	400	2	BBN0112810220006	-	-	-

LINGO REGALSYSTEM

DOPPELSEITIG - HOCH RÜCKWAND - ROLLENPLATTE - FÜR ABDECKFACHBODEN

Lackierte und furnierte Lingo Regale haben das FSC Zertifikat.

H920 mm

Achsmaß mm	FB Tiefe mm	Sektionen	Bestell-Nr.	Melamin	Lackiert	Furniert
500	250	1	BBN0113450120006	-	-	-
500	250	2	BBN0113450220006	-	-	-
500	250	3	BBN0113450320006	-	-	-
500	300	1	BBN0113650120006	-	-	-
500	300	2	BBN0113650220006	-	-	-
500	300	3	BBN0113650320006	-	-	-
500	400	1	BBN0113850120006	-	-	-
500	400	2	BBN0113850220006	-	-	-
500	400	3	BBN0113850320006	-	-	-
750	250	1	BBN0113470120006	-	-	-
750	250	2	BBN0113470220006	-	-	-
750	250	3	BBN0113470320006	-	-	-
750	300	1	BBN0113670120006	-	-	-
750	300	2	BBN0113670220006	-	-	-
750	300	3	BBN0113670320006	-	-	-
750	400	1	BBN0113870120006	-	-	-
750	400	2	BBN0113870220006	-	-	-
750	400	3	BBN0113870320006	-	-	-
900	250	1	BBN0113490120006	-	-	-
900	250	2	BBN0113490220006	-	-	-
900	300	1	BBN0113690120006	-	-	-
900	300	2	BBN0113690220006	-	-	-
900	400	1	BBN0113890120006	-	-	-
900	400	2	BBN0113890220006	-	-	-
1000	250	1	BBN0113410120006	-	-	-
1000	250	2	BBN0113410220006	-	-	-
1000	300	1	BBN0113610120006	-	-	-
1000	300	2	BBN0113610220006	-	-	-
1000	400	1	BBN0113810120006	-	-	-
1000	400	2	BBN0113810220006	-	-	-

LINGO REGALSYSTEM

DOPPELSEITIG - HOCH RÜCKWAND - ROLLENPLATTE - FÜR ABDECKFACHBODEN

Lackierte und furnierte Lingo Regale haben das FSC Zertifikat.

H1220 mm

Achsmaß mm	FB Tiefe mm	Sektionen	Bestell-Nr.	Melamin	Lackiert	Furniert
500	250	1	BBN0114450120006	-	-	-
500	250	2	BBN0114450220006	-	-	-
500	250	3	BBN0114450320006	-	-	-
500	300	1	BBN0114650120006	-	-	-
500	300	2	BBN0114650220006	-	-	-
500	300	3	BBN0114650320006	-	-	-
500	400	1	BBN0114850120006	-	-	-
500	400	2	BBN0114850220006	-	-	-
500	400	3	BBN0114850320006	-	-	-
750	250	1	BBN0114470120006	-	-	-
750	250	2	BBN0114470220006	-	-	-
750	250	3	BBN0114470320006	-	-	-
750	300	1	BBN0114670120006	-	-	-
750	300	2	BBN0114670220006	-	-	-
750	300	3	BBN0114670320006	-	-	-
750	400	1	BBN0114870120006	-	-	-
750	400	2	BBN0114870220006	-	-	-
750	400	3	BBN0114870320006	-	-	-
900	250	1	BBN0114490120006	-	-	-
900	250	2	BBN0114490220006	-	-	-
900	300	1	BBN0114690120006	-	-	-
900	300	2	BBN0114690220006	-	-	-
900	400	1	BBN0114890120006	-	-	-
900	400	2	BBN0114890220006	-	-	-
1000	250	1	BBN0114410120006	-	-	-
1000	250	2	BBN0114410220006	-	-	-
1000	300	1	BBN0114610120006	-	-	-
1000	300	2	BBN0114610220006	-	-	-
1000	400	1	BBN0114810120006	-	-	-
1000	400	2	BBN0114810220006	-	-	-

LINGO REGALSYSTEM

DOPPELSEITIG - HOCH RÜCKWAND - ROLLENPLATTE - FÜR ABDECKFACHBODEN

Lackierte und furnierte Lingo Regale haben das FSC Zertifikat.

H1520 mm

Achsmaß mm	FB Tiefe mm	Sektionen	Bestell-Nr.	Melamin	Lackiert	Furniert
500	250	1	BBN0115450120006	-	-	-
500	250	2	BBN0115450220006	-	-	-
500	250	3	BBN0115450320006	-	-	-
500	300	1	BBN0115650120006	-	-	-
500	300	2	BBN0115650220006	-	-	-
500	300	3	BBN0115650320006	-	-	-
500	400	1	BBN0115850120006	-	-	-
500	400	2	BBN0115850220006	-	-	-
500	400	3	BBN0115850320006	-	-	-
750	250	1	BBN0115470120006	-	-	-
750	250	2	BBN0115470220006	-	-	-
750	250	3	BBN0115470320006	-	-	-
750	300	1	BBN0115670120006	-	-	-
750	300	2	BBN0115670220006	-	-	-
750	300	3	BBN0115670320006	-	-	-
750	400	1	BBN0115870120006	-	-	-
750	400	2	BBN0115870220006	-	-	-
750	400	3	BBN0115870320006	-	-	-
900	250	1	BBN0115490120006	-	-	-
900	250	2	BBN0115490220006	-	-	-
900	300	1	BBN0115690120006	-	-	-
900	300	2	BBN0115690220006	-	-	-
900	400	1	BBN0115890120006	-	-	-
900	400	2	BBN0115890220006	-	-	-
1000	250	1	BBN0115410120006	-	-	-
1000	250	2	BBN0115410220006	-	-	-
1000	300	1	BBN0115610120006	-	-	-
1000	300	2	BBN0115610220006	-	-	-
1000	400	1	BBN0115810120006	-	-	-
1000	400	2	BBN0115810220006	-	-	-

LINGO REGALSYSTEM

BBN011 - NIEDRIG RÜCKWAND - ROLLENPLATTE - FÜR ABDECKFACHBODEN



LINGO REGALSYSTEM

BBN011 - NIEDRIG RÜCKWAND - ROLLENPLATTE - FÜR ABDECKFACHBODEN

Regalsystem mit Holzseiten, niedrig Holzrückwand und Rollenplatte.

Zur Verwendung mit ST1 einseitig Volltiefe, WT1 einseitig Volltiefe und WT1 doppelseitig Abdeckboden.

- Preis basiert auf Metallpreisgruppe 1 und Holzpreisgruppe A (siehe Designauswahl Seiten 6-9).
- Für Fachböden siehe Seite 128.
- Für Funktionen siehe Seite 168.

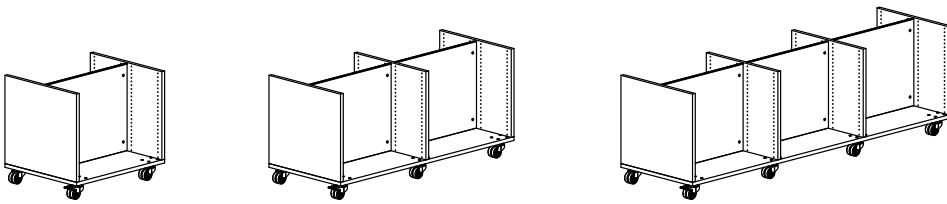

Doppelseitiges Regal - H720 mm - 1/2/3 Sektionen

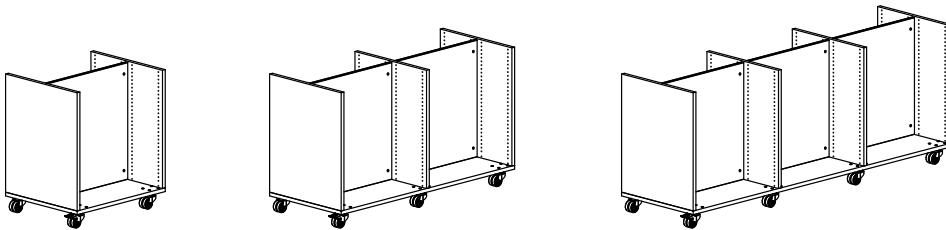

Doppelseitiges Regal - H920 mm - 1/2/3 Sektionen

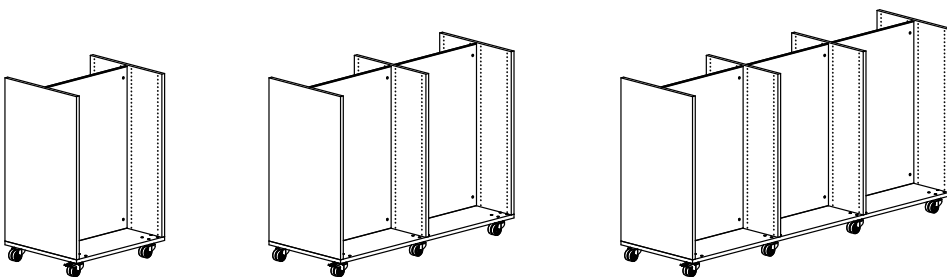

Doppelseitiges Regal - H1220 mm - 1/2/3 Sektionen

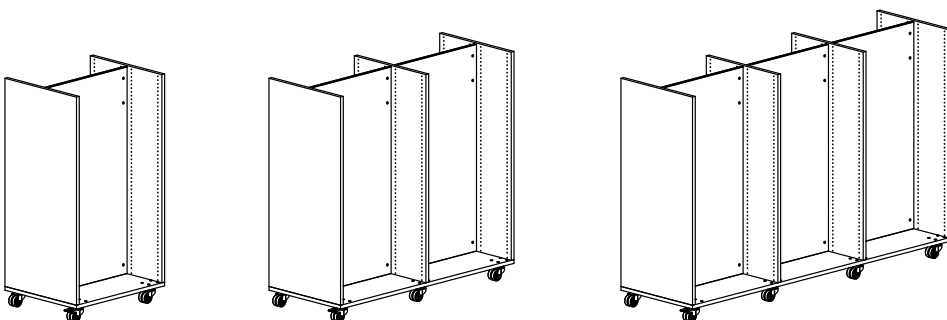

Doppelseitiges Regal - H1520 mm - 1/2/3 Sektionen

LINGO REGALSYSTEM

DOPPELSEITIG - NIEDRIG RÜCKWAND - ROLLENPLATTE - FÜR ABDECKFACHBODEN

Lackierte und furnierte Lingo Regale haben das FSC Zertifikat.

H720 mm

Achsmaß mm	FB Tiefe mm	Sektionen	Bestell-Nr.	Melamin	Lackiert	Furniert
500	250	1	BBN011245011000.	-	-	-
500	250	2	BBN011245021000.	-	-	-
500	250	3	BBN011245031000.	-	-	-
500	300	1	BBN011265011000.	-	-	-
500	300	2	BBN011265021000.	-	-	-
500	300	3	BBN011265031000.	-	-	-
500	400	1	BBN011285011000.	-	-	-
500	400	2	BBN011285021000.	-	-	-
500	400	3	BBN011285031000.	-	-	-
750	250	1	BBN011247011000.	-	-	-
750	250	2	BBN011247021000.	-	-	-
750	250	3	BBN011247031000.	-	-	-
750	300	1	BBN011267011000.	-	-	-
750	300	2	BBN011267021000.	-	-	-
750	300	3	BBN011267031000.	-	-	-
750	400	1	BBN011287011000.	-	-	-
750	400	2	BBN011287021000.	-	-	-
750	400	3	BBN011287031000.	-	-	-
900	250	1	BBN011249011000.	-	-	-
900	250	2	BBN011249021000.	-	-	-
900	300	1	BBN011269011000.	-	-	-
900	300	2	BBN011269021000.	-	-	-
900	400	1	BBN011289011000.	-	-	-
900	400	2	BBN011289021000.	-	-	-
1000	250	1	BBN011241011000.	-	-	-
1000	250	2	BBN011241021000.	-	-	-
1000	300	1	BBN011261011000.	-	-	-
1000	300	2	BBN011261021000.	-	-	-
1000	400	1	BBN011281011000.	-	-	-
1000	400	2	BBN011281021000.	-	-	-

LINGO REGALSYSTEM

DOPPELSEITIG - NIEDRIG RÜCKWAND - ROLLENPLATTE - FÜR ABDECKFACHBODEN

Lackierte und furnierte Lingo Regale haben das FSC Zertifikat.

H920 mm

Achsmaß mm	FB Tiefe mm	Sektionen	Bestell-Nr.	Melamin	Lackiert	Furniert
500	250	1	BBN011345011000.	-	-	-
500	250	2	BBN011345021000.	-	-	-
500	250	3	BBN011345031000.	-	-	-
500	300	1	BBN011365011000.	-	-	-
500	300	2	BBN011365021000.	-	-	-
500	300	3	BBN011365031000.	-	-	-
500	400	1	BBN011385011000.	-	-	-
500	400	2	BBN011385021000.	-	-	-
500	400	3	BBN011385031000.	-	-	-
750	250	1	BBN011347011000.	-	-	-
750	250	2	BBN011347021000.	-	-	-
750	250	3	BBN011347031000.	-	-	-
750	300	1	BBN011367011000.	-	-	-
750	300	2	BBN011367021000.	-	-	-
750	300	3	BBN011367031000.	-	-	-
750	400	1	BBN011387011000.	-	-	-
750	400	2	BBN011387021000.	-	-	-
750	400	3	BBN011387031000.	-	-	-
900	250	1	BBN011349011000.	-	-	-
900	250	2	BBN011349021000.	-	-	-
900	300	1	BBN011369011000.	-	-	-
900	300	2	BBN011369021000.	-	-	-
900	400	1	BBN011389011000.	-	-	-
900	400	2	BBN011389021000.	-	-	-
1000	250	1	BBN011341011000.	-	-	-
1000	250	2	BBN011341021000.	-	-	-
1000	300	1	BBN011361011000.	-	-	-
1000	300	2	BBN011361021000.	-	-	-
1000	400	1	BBN011381011000.	-	-	-
1000	400	2	BBN011381021000.	-	-	-

LINGO REGALSYSTEM

DOPPELSEITIG - NIEDRIG RÜCKWAND - ROLLENPLATTE - FÜR ABDECKFACHBODEN

Lackierte und furnierte Lingo Regale haben das FSC Zertifikat.

H1220 mm

Achsmaß mm	FB Tiefe mm	Sektionen	Bestell-Nr.	Melamin	Lackiert	Furniert
500	250	1	BBN011445011000.	-	-	-
500	250	2	BBN011445021000.	-	-	-
500	250	3	BBN011445031000.	-	-	-
500	300	1	BBN011465011000.	-	-	-
500	300	2	BBN011465021000.	-	-	-
500	300	3	BBN011465031000.	-	-	-
500	400	1	BBN011485011000.	-	-	-
500	400	2	BBN011485021000.	-	-	-
500	400	3	BBN011485031000.	-	-	-
750	250	1	BBN011447011000.	-	-	-
750	250	2	BBN011447021000.	-	-	-
750	250	3	BBN011447031000.	-	-	-
750	300	1	BBN011467011000.	-	-	-
750	300	2	BBN011467021000.	-	-	-
750	300	3	BBN011467031000.	-	-	-
750	400	1	BBN011487011000.	-	-	-
750	400	2	BBN011487021000.	-	-	-
750	400	3	BBN011487031000.	-	-	-
900	250	1	BBN011449011000.	-	-	-
900	250	2	BBN011449021000.	-	-	-
900	300	1	BBN011469011000.	-	-	-
900	300	2	BBN011469021000.	-	-	-
900	400	1	BBN011489011000.	-	-	-
900	400	2	BBN011489021000.	-	-	-
1000	250	1	BBN011441011000.	-	-	-
1000	250	2	BBN011441021000.	-	-	-
1000	300	1	BBN011461011000.	-	-	-
1000	300	2	BBN011461021000.	-	-	-
1000	400	1	BBN011481011000.	-	-	-
1000	400	2	BBN011481021000.	-	-	-

LINGO REGALSYSTEM

DOPPELSEITIG - NIEDRIG RÜCKWAND - ROLLENPLATTE - FÜR ABDECKFACHBODEN

Lackierte und furnierte Lingo Regale haben das FSC Zertifikat.

H1520 mm

Achsmaß mm	FB Tiefe mm	Sektionen	Bestell-Nr.	Melamin	Lackiert	Furniert
500	250	1	BBN011545011000.	-	-	-
500	250	2	BBN011545021000.	-	-	-
500	250	3	BBN011545031000.	-	-	-
500	300	1	BBN011565011000.	-	-	-
500	300	2	BBN011565021000.	-	-	-
500	300	3	BBN011565031000.	-	-	-
500	400	1	BBN011585011000.	-	-	-
500	400	2	BBN011585021000.	-	-	-
500	400	3	BBN011585031000.	-	-	-
750	250	1	BBN011547011000.	-	-	-
750	250	2	BBN011547021000.	-	-	-
750	250	3	BBN011547031000.	-	-	-
750	300	1	BBN011567011000.	-	-	-
750	300	2	BBN011567021000.	-	-	-
750	300	3	BBN011567031000.	-	-	-
750	400	1	BBN011587011000.	-	-	-
750	400	2	BBN011587021000.	-	-	-
750	400	3	BBN011587031000.	-	-	-
900	250	1	BBN011549011000.	-	-	-
900	250	2	BBN011549021000.	-	-	-
900	300	1	BBN011569011000.	-	-	-
900	300	2	BBN011569021000.	-	-	-
900	400	1	BBN011589011000.	-	-	-
900	400	2	BBN011589021000.	-	-	-
1000	250	1	BBN011541011000.	-	-	-
1000	250	2	BBN011541021000.	-	-	-
1000	300	1	BBN011561011000.	-	-	-
1000	300	2	BBN011561021000.	-	-	-
1000	400	1	BBN011581011000.	-	-	-
1000	400	2	BBN011581021000.	-	-	-

LINGO REGALSYSTEM

BBN011 - DIAGONALTRAVERSE - ROLLENPLATTE - FÜR ABDECKFACHBODEN



LINGO REGALSYSTEM

BBN011 - DIAGONALTRAVERSE - ROLLENPLATTE - FÜR ABDECKFACHBODEN

Regalsystem mit Holzseiten, Diagonaltraverse und Rollenplatte. Zur Verwendung mit Abdeckfachboden. 1 Zwischenfachboden muß mit den Holzseiten bei Höhe H1520 mm verschraubt werden.

- Preis basiert auf Metallpreisgruppe 1 und Holzpreisgruppe A (siehe Designauswahl Seiten 6-9).
- Für Fachböden siehe Seite 128.
- Für Funktionen siehe Seite 168.

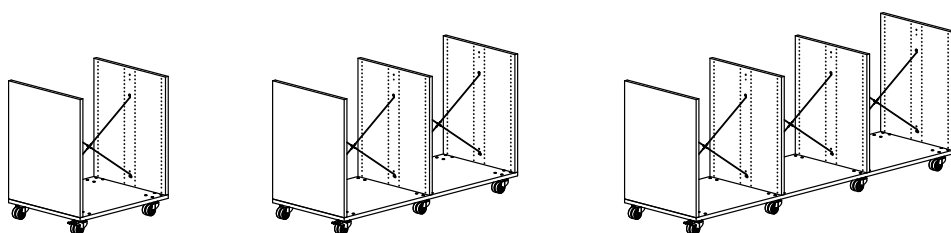

Doppelseitiges Regal - H920 mm - 1/2/3 Sektionen

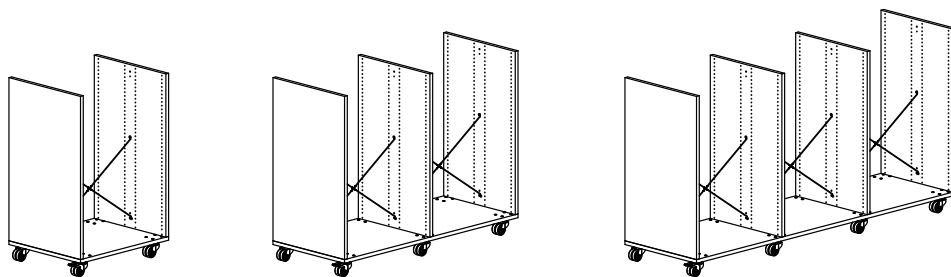

Doppelseitiges Regal - H1220 mm - 1/2/3 Sektionen

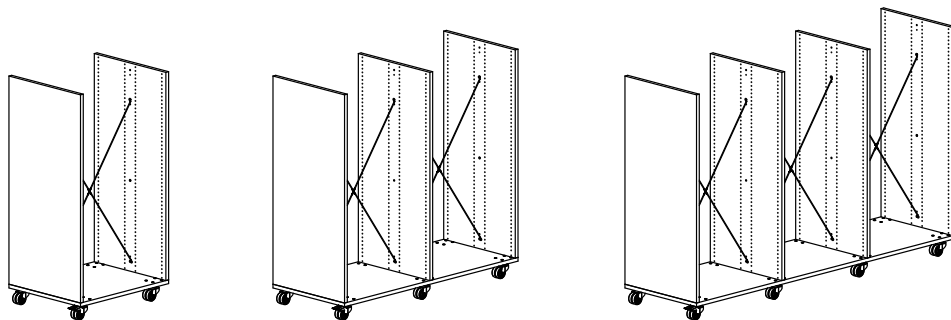

Doppelseitiges Regal - H1520 mm - 1/2/3 Sektionen

LINGO REGALSYSTEM

DOPPELSEITIG - DIAGONALTRAVERSE - ROLLENPLATTE - FÜR ABDECKFACHBODEN

Lackierte und furnierte Lingo Regale haben das FSC Zertifikat.

H920 mm

Achsmaß mm	FB Tiefe mm	Sektionen	Bestell-Nr.	Melamin	Lackiert	Furniert
500	250	1	BBN011345019000.	-	-	-
500	250	2	BBN011345029000.	-	-	-
500	250	3	BBN011345039000.	-	-	-
500	300	1	BBN011365019000.	-	-	-
500	300	2	BBN011365029000.	-	-	-
500	300	3	BBN011365039000.	-	-	-
500	400	1	BBN011385019000.	-	-	-
500	400	2	BBN011385029000.	-	-	-
500	400	3	BBN011385039000.	-	-	-
750	250	1	BBN011347019000.	-	-	-
750	250	2	BBN011347029000.	-	-	-
750	250	3	BBN011347039000.	-	-	-
750	300	1	BBN011367019000.	-	-	-
750	300	2	BBN011367029000.	-	-	-
750	300	3	BBN011367039000.	-	-	-
750	400	1	BBN011387019000.	-	-	-
750	400	2	BBN011387029000.	-	-	-
750	400	3	BBN011387039000.	-	-	-
900	250	1	BBN011349019000.	-	-	-
900	250	2	BBN011349029000.	-	-	-
900	300	1	BBN011369019000.	-	-	-
900	300	2	BBN011369029000.	-	-	-
900	400	1	BBN011389019000.	-	-	-
900	400	2	BBN011389029000.	-	-	-
1000	250	1	BBN011341019000.	-	-	-
1000	250	2	BBN011341029000.	-	-	-
1000	300	1	BBN011361019000.	-	-	-
1000	300	2	BBN011361029000.	-	-	-
1000	400	1	BBN011381019000.	-	-	-
1000	400	2	BBN011381029000.	-	-	-

LINGO REGALSYSTEM

DOPPELSEITIG - DIAGONALTRAVERSE - ROLLENPLATTE - FÜR ABDECKFACHBODEN

Lackierte und furnierte Lingo Regale haben das FSC Zertifikat.

H1220 mm

Achsmaß mm	FB Tiefe mm	Sektionen	Bestell-Nr.	Melamin	Lackiert	Furniert
500	250	1	BBN011445019000.	-	-	-
500	250	2	BBN011445029000.	-	-	-
500	250	3	BBN011445039000.	-	-	-
500	300	1	BBN011465019000.	-	-	-
500	300	2	BBN011465029000.	-	-	-
500	300	3	BBN011465039000.	-	-	-
500	400	1	BBN011485019000.	-	-	-
500	400	2	BBN011485029000.	-	-	-
500	400	3	BBN011485039000.	-	-	-
750	250	1	BBN011447019000.	-	-	-
750	250	2	BBN011447029000.	-	-	-
750	250	3	BBN011447039000.	-	-	-
750	300	1	BBN011467019000.	-	-	-
750	300	2	BBN011467029000.	-	-	-
750	300	3	BBN011467039000.	-	-	-
750	400	1	BBN011487019000.	-	-	-
750	400	2	BBN011487029000.	-	-	-
750	400	3	BBN011487039000.	-	-	-
900	250	1	BBN011449019000.	-	-	-
900	250	2	BBN011449029000.	-	-	-
900	300	1	BBN011469019000.	-	-	-
900	300	2	BBN011469029000.	-	-	-
900	400	1	BBN011489019000.	-	-	-
900	400	2	BBN011489029000.	-	-	-
1000	250	1	BBN011441019000.	-	-	-
1000	250	2	BBN011441029000.	-	-	-
1000	300	1	BBN011461019000.	-	-	-
1000	300	2	BBN011461029000.	-	-	-
1000	400	1	BBN011481019000.	-	-	-
1000	400	2	BBN011481029000.	-	-	-

LINGO REGALSYSTEM

DOPPELSEITIG - DIAGONALTRAVERSE - ROLLENPLATTE - FÜR ABDECKFACHBODEN

Lackierte und furnierte Lingo Regale haben das FSC Zertifikat.

H1520 mm

Achsmaß mm	FB Tiefe mm	Sektionen	Bestell-Nr.	Melamin	Lackiert	Furniert
500	250	1	BBN011545019000.	-	-	-
500	250	2	BBN011545029000.	-	-	-
500	250	3	BBN011545039000.	-	-	-
500	300	1	BBN011565019000.	-	-	-
500	300	2	BBN011565029000.	-	-	-
500	300	3	BBN011565039000.	-	-	-
500	400	1	BBN011585019000.	-	-	-
500	400	2	BBN011585029000.	-	-	-
500	400	3	BBN011585039000.	-	-	-
750	250	1	BBN011547019000.	-	-	-
750	250	2	BBN011547029000.	-	-	-
750	250	3	BBN011547039000.	-	-	-
750	300	1	BBN011567019000.	-	-	-
750	300	2	BBN011567029000.	-	-	-
750	300	3	BBN011567039000.	-	-	-
750	400	1	BBN011587019000.	-	-	-
750	400	2	BBN011587029000.	-	-	-
750	400	3	BBN011587039000.	-	-	-
900	250	1	BBN011549019000.	-	-	-
900	250	2	BBN011549029000.	-	-	-
900	300	1	BBN011569019000.	-	-	-
900	300	2	BBN011569029000.	-	-	-
900	400	1	BBN011589019000.	-	-	-
900	400	2	BBN011589029000.	-	-	-
1000	250	1	BBN011541019000.	-	-	-
1000	250	2	BBN011541029000.	-	-	-
1000	300	1	BBN011561019000.	-	-	-
1000	300	2	BBN011561029000.	-	-	-
1000	400	1	BBN011581019000.	-	-	-
1000	400	2	BBN011581029000.	-	-	-



LINGO REGALSYSTEM

BBN012 - RAHMEN TRAVVERSE - ROLLENPLATTE - MIT HOLZABDECKPLATTE



LINGO REGALSYSTEM

BBN012 - RAHMENRAVERSE - ROLLENPLATTE - MIT HOLZABDECKPLATTE

Regalsystem mit Holzseiten, Metallrahmenraverse, Rollenplatte und überliegender Holzabdeckplatte.

- Preis basiert auf Metallpreisgruppe 1 und Holzpreisgruppe A (siehe Designauswahl Seiten 6-9).
- Für Fachböden siehe Seite 128.
- Für Funktionen siehe Seite 168.

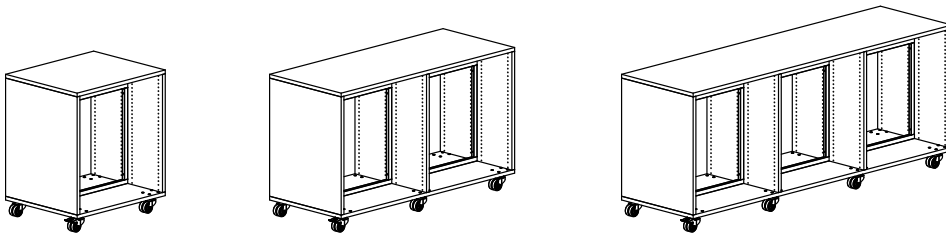

Doppelseitiges Regal - H920 mm - 1/2/3 Sektionen

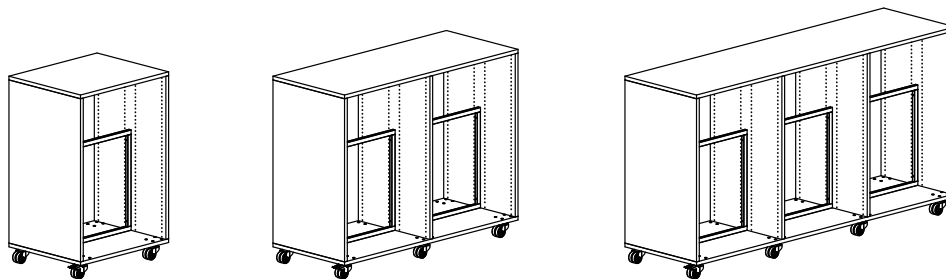

Doppelseitiges Regal - H1220 mm - 1/2/3 Sektionen

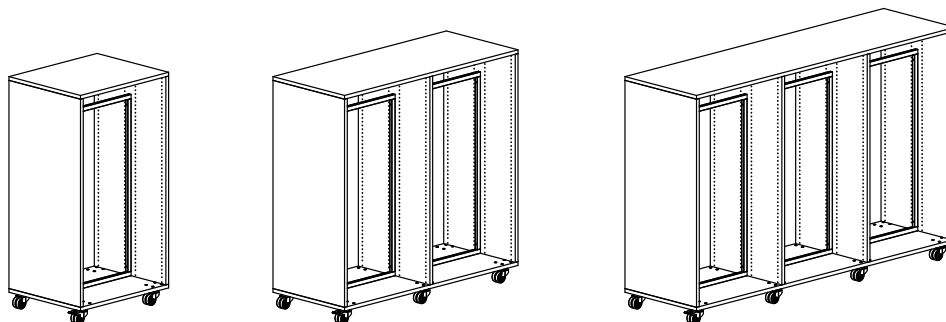

Doppelseitiges Regal - H1520 mm - 1/2/3 Sektionen

LINGO REGALSYSTEM

DOPPELSEITIG - RAHMENRAVERSE - ROLLENPLATTE - MIT HOLZABDECKPLATTE

Lackierte und furnierte Lingo Regale haben das FSC Zertifikat.

H920 mm

Achsmaß mm	FB Tiefe mm	Sektionen	Bestell-Nr.	Melamin	Lackiert	Furniert
500	250	1	BBN012345016100.	-	-	-
500	250	2	BBN012345026100.	-	-	-
500	250	3	BBN012345036100.	-	-	-
500	300	1	BBN012365016100.	-	-	-
500	300	2	BBN012365026100.	-	-	-
500	300	3	BBN012365036100.	-	-	-
500	400	1	BBN012385016100.	-	-	-
500	400	2	BBN012385026100.	-	-	-
500	400	3	BBN012385036100.	-	-	-
750	250	1	BBN012347016100.	-	-	-
750	250	2	BBN012347026100.	-	-	-
750	250	3	BBN012347036100.	-	-	-
750	300	1	BBN012367016100.	-	-	-
750	300	2	BBN012367026100.	-	-	-
750	300	3	BBN012367036100.	-	-	-
750	400	1	BBN012387016100.	-	-	-
750	400	2	BBN012387026100.	-	-	-
750	400	3	BBN012387036100.	-	-	-
900	250	1	BBN012349016100.	-	-	-
900	250	2	BBN012349026100.	-	-	-
900	300	1	BBN012369016100.	-	-	-
900	300	2	BBN012369026100.	-	-	-
900	400	1	BBN012389016100.	-	-	-
900	400	2	BBN012389026100.	-	-	-
1000	250	1	BBN012341016100.	-	-	-
1000	250	2	BBN012341026100.	-	-	-
1000	300	1	BBN012361016100.	-	-	-
1000	300	2	BBN012361026100.	-	-	-
1000	400	1	BBN012381016100.	-	-	-
1000	400	2	BBN012381026100.	-	-	-

LINGO REGALSYSTEM

DOPPELSEITIG - RAHMENRAVERSE - ROLLENPLATTE - MIT HOLZABDECKPLATTE

Lackierte und furnierte Lingo Regale haben das FSC Zertifikat.

H1220 mm

Achsmaß mm	FB Tiefe mm	Sektionen	Bestell-Nr.	Melamin	Lackiert	Furniert
500	250	1	BBN012445016100.	-	-	-
500	250	2	BBN012445026100.	-	-	-
500	250	3	BBN012445036100.	-	-	-
500	300	1	BBN012465016100.	-	-	-
500	300	2	BBN012465026100.	-	-	-
500	300	3	BBN012465036100.	-	-	-
500	400	1	BBN012485016100.	-	-	-
500	400	2	BBN012485026100.	-	-	-
500	400	3	BBN012485036100.	-	-	-
750	250	1	BBN012447016100.	-	-	-
750	250	2	BBN012447026100.	-	-	-
750	250	3	BBN012447036100.	-	-	-
750	300	1	BBN012467016100.	-	-	-
750	300	2	BBN012467026100.	-	-	-
750	300	3	BBN012467036100.	-	-	-
750	400	1	BBN012487016100.	-	-	-
750	400	2	BBN012487026100.	-	-	-
750	400	3	BBN012487036100.	-	-	-
900	250	1	BBN012449016100.	-	-	-
900	250	2	BBN012449026100.	-	-	-
900	300	1	BBN012469016100.	-	-	-
900	300	2	BBN012469026100.	-	-	-
900	400	1	BBN012489016100.	-	-	-
900	400	2	BBN012489026100.	-	-	-
1000	250	1	BBN012441016100.	-	-	-
1000	250	2	BBN012441026100.	-	-	-
1000	300	1	BBN012461016100.	-	-	-
1000	300	2	BBN012461026100.	-	-	-
1000	400	1	BBN012481016100.	-	-	-
1000	400	2	BBN012481026100.	-	-	-

LINGO REGALSYSTEM

DOPPELSEITIG - RAHMENRAVERSE - ROLLENPLATTE - MIT HOLZABDECKPLATTE

Lackierte und furnierte Lingo Regale haben das FSC Zertifikat.

H1520 mm

Achsmaß mm	FB Tiefe mm	Sektionen	Bestell-Nr.	Melamin	Lackiert	Furniert
500	250	1	BBN012545016100.	-	-	-
500	250	2	BBN012545026100.	-	-	-
500	250	3	BBN012545036100.	-	-	-
500	300	1	BBN012565016100.	-	-	-
500	300	2	BBN012565026100.	-	-	-
500	300	3	BBN012565036100.	-	-	-
500	400	1	BBN012585016100.	-	-	-
500	400	2	BBN012585026100.	-	-	-
500	400	3	BBN012585036100.	-	-	-
750	250	1	BBN012547016100.	-	-	-
750	250	2	BBN012547026100.	-	-	-
750	250	3	BBN012547036100.	-	-	-
750	300	1	BBN012567016100.	-	-	-
750	300	2	BBN012567026100.	-	-	-
750	300	3	BBN012567036100.	-	-	-
750	400	1	BBN012587016100.	-	-	-
750	400	2	BBN012587026100.	-	-	-
750	400	3	BBN012587036100.	-	-	-
900	250	1	BBN012549016100.	-	-	-
900	250	2	BBN012549026100.	-	-	-
900	300	1	BBN012569016100.	-	-	-
900	300	2	BBN012569026100.	-	-	-
900	400	1	BBN012589016100.	-	-	-
900	400	2	BBN012589026100.	-	-	-
1000	250	1	BBN012541016100.	-	-	-
1000	250	2	BBN012541026100.	-	-	-
1000	300	1	BBN012561016100.	-	-	-
1000	300	2	BBN012561026100.	-	-	-
1000	400	1	BBN012581016100.	-	-	-
1000	400	2	BBN012581026100.	-	-	-



LINGO REGALSYSTEM

BBN012 - RÜCKWAND - ROLLENPLATTE - MIT HOLZABDECKPLATTE



LINGO REGALSYSTEM

BBN012 - RÜCKWAND - ROLLENPLATTE - MIT HOLZABDECKPLATTE

Regalsystem mit Holzseiten, Holzrückwand, Rollenplatte und überliegender Holzabdeckplatte.

- Preis basiert auf Metallpreisgruppe 1 und Holzpreisgruppe A (siehe Designauswahl Seiten 6-9).
- Für Fachböden siehe Seite 128.
- Für Funktionen siehe Seite 168.

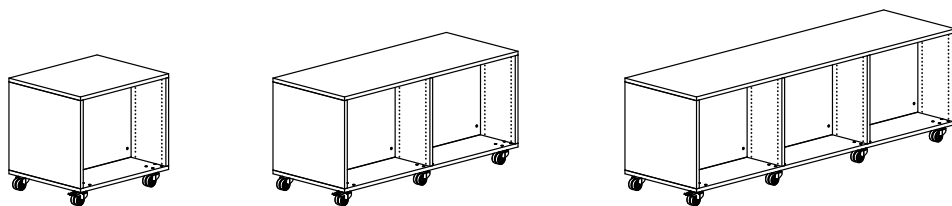

Doppelseitiges Regal - H720 mm - 1/2/3 Sektionen

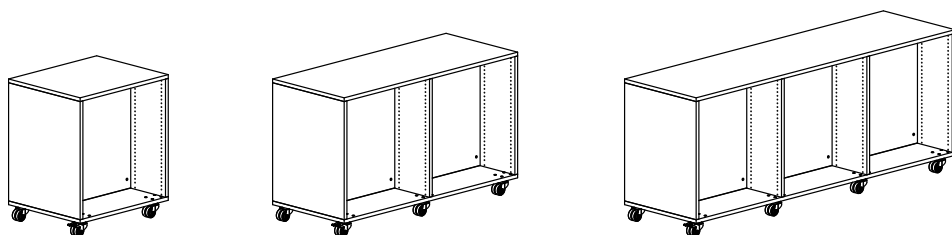

Doppelseitiges Regal - H920 mm - 1/2/3 Sektionen

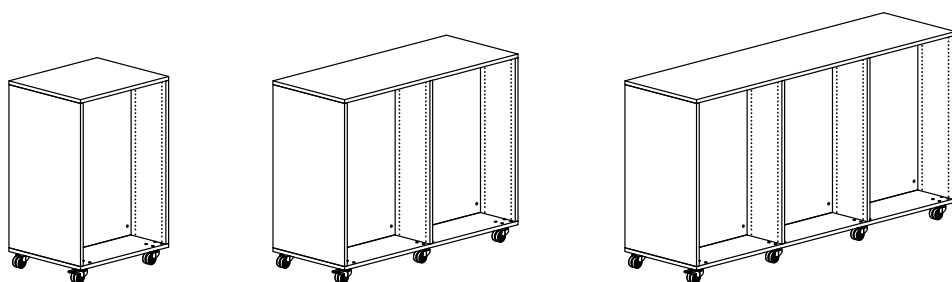

Doppelseitiges Regal - H1220 mm - 1/2/3 Sektionen

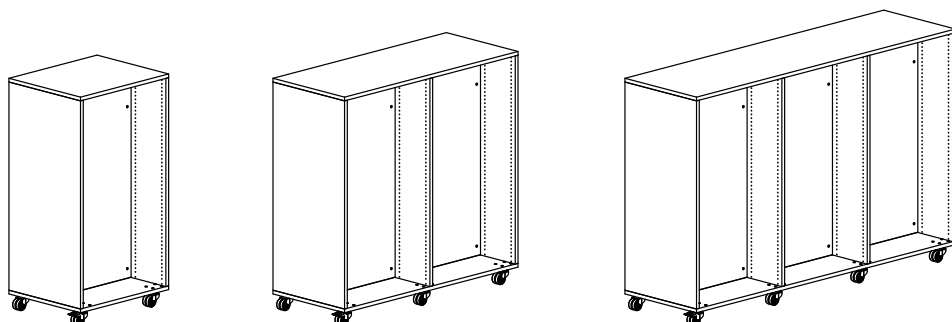

Doppelseitiges Regal - H1520 mm - 1/2/3 Sektionen

LINGO REGALSYSTEM

DOPPELSEITIG - RÜCKWAND - ROLLENPLATTE - MIT HOLZABDECKPLATTE

Lackierte und furnierte Lingo Regale haben das FSC Zertifikat.

H720 mm

Achsmaß mm	FB Tiefe mm	Sektionen	Bestell-Nr.	Melamin	Lackiert	Furniert
500	250	1	BBN012245012100.	-	-	-
500	250	2	BBN012245022100.	-	-	-
500	250	3	BBN012245032100.	-	-	-
500	300	1	BBN012265012100.	-	-	-
500	300	2	BBN012265022100.	-	-	-
500	300	3	BBN012265032100.	-	-	-
500	400	1	BBN012285012100.	-	-	-
500	400	2	BBN012285022100.	-	-	-
500	400	3	BBN012285032100.	-	-	-
750	250	1	BBN012247012100.	-	-	-
750	250	2	BBN012247022100.	-	-	-
750	250	3	BBN012247032100.	-	-	-
750	300	1	BBN012267012100.	-	-	-
750	300	2	BBN012267022100.	-	-	-
750	300	3	BBN012267032100.	-	-	-
750	400	1	BBN012287012100.	-	-	-
750	400	2	BBN012287022100.	-	-	-
750	400	3	BBN012287032100.	-	-	-
900	250	1	BBN012249012100.	-	-	-
900	250	2	BBN012249022100.	-	-	-
900	300	1	BBN012269012100.	-	-	-
900	300	2	BBN012269022100.	-	-	-
900	400	1	BBN012289012100.	-	-	-
900	400	2	BBN012289022100.	-	-	-
1000	250	1	BBN012241012100.	-	-	-
1000	250	2	BBN012241022100.	-	-	-
1000	300	1	BBN012261012100.	-	-	-
1000	300	2	BBN012261022100.	-	-	-
1000	400	1	BBN012281012100.	-	-	-
1000	400	2	BBN012281022100.	-	-	-

LINGO REGALSYSTEM

DOPPELSEITIG - RÜCKWAND - ROLLENPLATTE - MIT HOLZABDECKPLATTE

Lackierte und furnierte Lingo Regale haben das FSC Zertifikat.

H920 mm

Achsmaß mm	FB Tiefe mm	Sektionen	Bestell-Nr.	Melamin	Lackiert	Furniert
500	250	1	BBN012345012100.	-	-	-
500	250	2	BBN012345022100.	-	-	-
500	250	3	BBN012345032100.	-	-	-
500	300	1	BBN012365012100.	-	-	-
500	300	2	BBN012365022100.	-	-	-
500	300	3	BBN012365032100.	-	-	-
500	400	1	BBN012385012100.	-	-	-
500	400	2	BBN012385022100.	-	-	-
500	400	3	BBN012385032100.	-	-	-
750	250	1	BBN012347012100.	-	-	-
750	250	2	BBN012347022100.	-	-	-
750	250	3	BBN012347032100.	-	-	-
750	300	1	BBN012367012100.	-	-	-
750	300	2	BBN012367022100.	-	-	-
750	300	3	BBN012367032100.	-	-	-
750	400	1	BBN012387012100.	-	-	-
750	400	2	BBN012387022100.	-	-	-
750	400	3	BBN012387032100.	-	-	-
900	250	1	BBN012349012100.	-	-	-
900	250	2	BBN012349022100.	-	-	-
900	300	1	BBN012369012100.	-	-	-
900	300	2	BBN012369022100.	-	-	-
900	400	1	BBN012389012100.	-	-	-
900	400	2	BBN012389022100.	-	-	-
1000	250	1	BBN012341012100.	-	-	-
1000	250	2	BBN012341022100.	-	-	-
1000	300	1	BBN012361012100.	-	-	-
1000	300	2	BBN012361022100.	-	-	-
1000	400	1	BBN012381012100.	-	-	-
1000	400	2	BBN012381022100.	-	-	-

LINGO REGALSYSTEM

DOPPELSEITIG - RÜCKWAND - ROLLENPLATTE - MIT HOLZABDECKPLATTE

Lackierte und furnierte Lingo Regale haben das FSC Zertifikat.

H1220 mm

Achsmaß mm	FB Tiefe mm	Sektionen	Bestell-Nr.	Melamin	Lackiert	Furniert
500	250	1	BBN012445012100.	-	-	-
500	250	2	BBN012445022100.	-	-	-
500	250	3	BBN012445032100.	-	-	-
500	300	1	BBN012465012100.	-	-	-
500	300	2	BBN012465022100.	-	-	-
500	300	3	BBN012465032100.	-	-	-
500	400	1	BBN012485012100.	-	-	-
500	400	2	BBN012485022100.	-	-	-
500	400	3	BBN012485032100.	-	-	-
750	250	1	BBN012447012100.	-	-	-
750	250	2	BBN012447022100.	-	-	-
750	250	3	BBN012447032100.	-	-	-
750	300	1	BBN012467012100.	-	-	-
750	300	2	BBN012467022100.	-	-	-
750	300	3	BBN012467032100.	-	-	-
750	400	1	BBN012487012100.	-	-	-
750	400	2	BBN012487022100.	-	-	-
750	400	3	BBN012487032100.	-	-	-
900	250	1	BBN012449012100.	-	-	-
900	250	2	BBN012449022100.	-	-	-
900	300	1	BBN012469012100.	-	-	-
900	300	2	BBN012469022100.	-	-	-
900	400	1	BBN012489012100.	-	-	-
900	400	2	BBN012489022100.	-	-	-
1000	250	1	BBN012441012100.	-	-	-
1000	250	2	BBN012441022100.	-	-	-
1000	300	1	BBN012461012100.	-	-	-
1000	300	2	BBN012461022100.	-	-	-
1000	400	1	BBN012481012100.	-	-	-
1000	400	2	BBN012481022100.	-	-	-

LINGO REGALSYSTEM

DOPPELSEITIG - RÜCKWAND - ROLLENPLATTE - MIT HOLZABDECKPLATTE

Lackierte und furnierte Lingo Regale haben das FSC Zertifikat.

H1520 mm

Achsmaß mm	FB Tiefe mm	Sektionen	Bestell-Nr.	Melamin	Lackiert	Furniert
500	250	1	BBN012545012100.	-	-	-
500	250	2	BBN012545022100.	-	-	-
500	250	3	BBN012545032100.	-	-	-
500	300	1	BBN012565012100.	-	-	-
500	300	2	BBN012565022100.	-	-	-
500	300	3	BBN012565032100.	-	-	-
500	400	1	BBN012585012100.	-	-	-
500	400	2	BBN012585022100.	-	-	-
500	400	3	BBN012585032100.	-	-	-
750	250	1	BBN012547012100.	-	-	-
750	250	2	BBN012547022100.	-	-	-
750	250	3	BBN012547032100.	-	-	-
750	300	1	BBN012567012100.	-	-	-
750	300	2	BBN012567022100.	-	-	-
750	300	3	BBN012567032100.	-	-	-
750	400	1	BBN012587012100.	-	-	-
750	400	2	BBN012587022100.	-	-	-
750	400	3	BBN012587032100.	-	-	-
900	250	1	BBN012549012100.	-	-	-
900	250	2	BBN012549022100.	-	-	-
900	300	1	BBN012569012100.	-	-	-
900	300	2	BBN012569022100.	-	-	-
900	400	1	BBN012589012100.	-	-	-
900	400	2	BBN012589022100.	-	-	-
1000	250	1	BBN012541012100.	-	-	-
1000	250	2	BBN012541022100.	-	-	-
1000	300	1	BBN012561012100.	-	-	-
1000	300	2	BBN012561022100.	-	-	-
1000	400	1	BBN012581012100.	-	-	-
1000	400	2	BBN012581022100.	-	-	-

LINGO REGALSYSTEM

BBN012 - DIAGONALTRAVERSE - ROLLENPLATTE - MIT HOLZABDECKPLATTE



LINGO REGALSYSTEM

BBN012 - DIAGONALTRAVERSE - ROLLENPLATTE - MIT HOLZABDECKPLATTE

Regalsystem mit Holzseiten, Diagonaltraverse und überliegender Holzabdeckplatte. 1 Zwischenfachboden muß mit den Holzseiten bei der Höhe H1520 mm verschraubt werden.

- Preis basiert auf Metallpreisgruppe 1 und Holzpreisgruppe A (siehe Designauswahl Seiten 6-9).
- Für Fachböden siehe Seite 128.
- Für Funktionen siehe Seite 168.

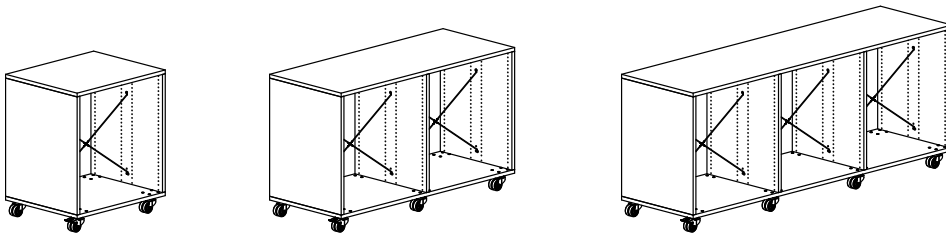

Doppelseitiges Regal - H920 mm - 1/2/3 Sektionen

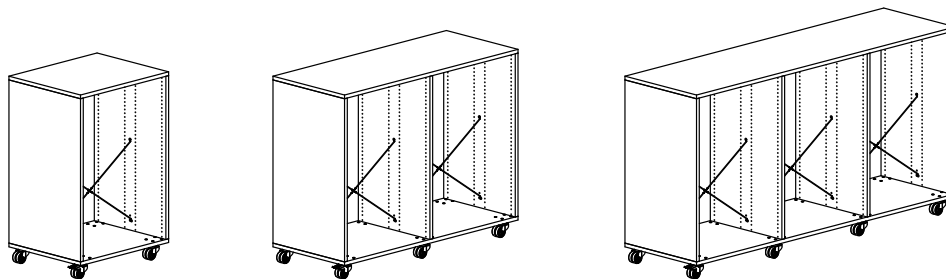

Doppelseitiges Regal - H1220 mm - 1/2/3 Sektionen

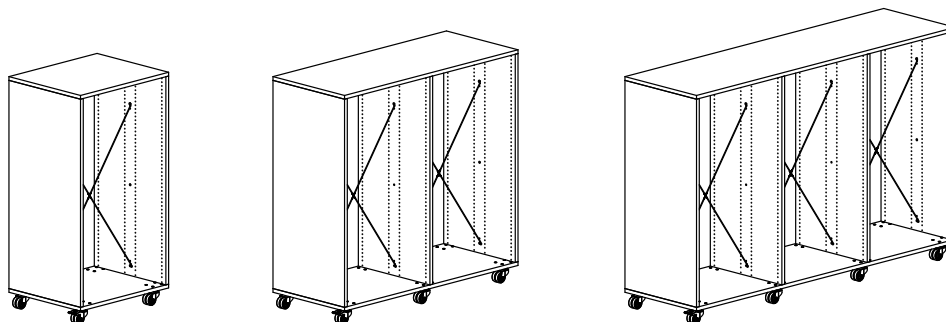

Doppelseitiges Regal - H1520 mm - 1/2/3 Sektionen

LINGO REGALSYSTEM

DOPPELSEITIG - DIAGONALTRAVERSE - ROLLENPLATTE - MIT HOLZABDECKPLATTE

Lackierte und furnierte Lingo Regale haben das FSC Zertifikat.

H920 mm

Achsmaß mm	FB Tiefe mm	Sektionen	Bestell-Nr.	Melamin	Lackiert	Furniert
500	250	1	BBN0123450191006	-	-	-
500	250	2	BBN0123450291006	-	-	-
500	250	3	BBN0123450391006	-	-	-
500	300	1	BBN0123650191006	-	-	-
500	300	2	BBN0123650291006	-	-	-
500	300	3	BBN0123650391006	-	-	-
500	400	1	BBN0123850191006	-	-	-
500	400	2	BBN0123850291006	-	-	-
500	400	3	BBN0123850391006	-	-	-
750	250	1	BBN0123470191006	-	-	-
750	250	2	BBN0123470291006	-	-	-
750	250	3	BBN0123470391006	-	-	-
750	300	1	BBN0123670191006	-	-	-
750	300	2	BBN0123670291006	-	-	-
750	300	3	BBN0123670391006	-	-	-
750	400	1	BBN0123870191006	-	-	-
750	400	2	BBN0123870291006	-	-	-
750	400	3	BBN0123870391006	-	-	-
900	250	1	BBN0123490191006	-	-	-
900	250	2	BBN0123490291006	-	-	-
900	300	1	BBN0123690191006	-	-	-
900	300	2	BBN0123690291006	-	-	-
900	400	1	BBN0123890191006	-	-	-
900	400	2	BBN0123890291006	-	-	-
1000	250	1	BBN0123410191006	-	-	-
1000	250	2	BBN0123410291006	-	-	-
1000	300	1	BBN0123610191006	-	-	-
1000	300	2	BBN0123610291006	-	-	-
1000	400	1	BBN0123810191006	-	-	-
1000	400	2	BBN0123810291006	-	-	-

LINGO REGALSYSTEM

DOPPELSEITIG - DIAGONALTRAVERSE - ROLLENPLATTE - MIT HOLZABDECKPLATTE

Lackierte und furnierte Lingo Regale haben das FSC Zertifikat.

H1220 mm

Achsmaß mm	FB Tiefe mm	Sektionen	Bestell-Nr.	Melamin	Lackiert	Furniert
500	250	1	BBN0124450191006	-	-	-
500	250	2	BBN0124450291006	-	-	-
500	250	3	BBN0124450391006	-	-	-
500	300	1	BBN0124650191006	-	-	-
500	300	2	BBN0124650291006	-	-	-
500	300	3	BBN0124650391006	-	-	-
500	400	1	BBN0124850191006	-	-	-
500	400	2	BBN0124850291006	-	-	-
500	400	3	BBN0124850391006	-	-	-
750	250	1	BBN0124470191006	-	-	-
750	250	2	BBN0124470291006	-	-	-
750	250	3	BBN0124470391006	-	-	-
750	300	1	BBN0124670191006	-	-	-
750	300	2	BBN0124670291006	-	-	-
750	300	3	BBN0124670391006	-	-	-
750	400	1	BBN0124870191006	-	-	-
750	400	2	BBN0124870291006	-	-	-
750	400	3	BBN0124870391006	-	-	-
900	250	1	BBN0124490191006	-	-	-
900	250	2	BBN0124490291006	-	-	-
900	300	1	BBN0124690191006	-	-	-
900	300	2	BBN0124690291006	-	-	-
900	400	1	BBN0124890191006	-	-	-
900	400	2	BBN0124890291006	-	-	-
1000	250	1	BBN0124410191006	-	-	-
1000	250	2	BBN0124410291006	-	-	-
1000	300	1	BBN0124610191006	-	-	-
1000	300	2	BBN0124610291006	-	-	-
1000	400	1	BBN0124810191006	-	-	-
1000	400	2	BBN0124810291006	-	-	-

LINGO REGALSYSTEM

DOPPELSEITIG - DIAGONALTRAVERSE - ROLLENPLATTE - MIT HOLZABDECKPLATTE

Lackierte und furnierte Lingo Regale haben das FSC Zertifikat.

H1520 mm

Achsmaß mm	FB Tiefe mm	Sektionen	Bestell-Nr.	Melamin	Lackiert	Furniert
500	250	1	BBN0125450191006	-	-	-
500	250	2	BBN0125450291006	-	-	-
500	250	3	BBN0125450391006	-	-	-
500	300	1	BBN0125650191006	-	-	-
500	300	2	BBN0125650291006	-	-	-
500	300	3	BBN0125650391006	-	-	-
500	400	1	BBN0125850191006	-	-	-
500	400	2	BBN0125850291006	-	-	-
500	400	3	BBN0125850391006	-	-	-
750	250	1	BBN0125470191006	-	-	-
750	250	2	BBN0125470291006	-	-	-
750	250	3	BBN0125470391006	-	-	-
750	300	1	BBN0125670191006	-	-	-
750	300	2	BBN0125670291006	-	-	-
750	300	3	BBN0125670391006	-	-	-
750	400	1	BBN0125870191006	-	-	-
750	400	2	BBN0125870291006	-	-	-
750	400	3	BBN0125870391006	-	-	-
900	250	1	BBN0125490191006	-	-	-
900	250	2	BBN0125490291006	-	-	-
900	300	1	BBN0125690191006	-	-	-
900	300	2	BBN0125690291006	-	-	-
900	400	1	BBN0125890191006	-	-	-
900	400	2	BBN0125890291006	-	-	-
1000	250	1	BBN0125410191006	-	-	-
1000	250	2	BBN0125410291006	-	-	-
1000	300	1	BBN0125610191006	-	-	-
1000	300	2	BBN0125610291006	-	-	-
1000	400	1	BBN0125810191006	-	-	-
1000	400	2	BBN0125810291006	-	-	-



LINGO SQUARE



LINGO SQUARE

MIT SOCKEL

Lingo Square kann in verschiedenen Umgebungen für Präsentation, Aufbewahrung, und Ausstellung verwendet werden. Die Abdeckplatte (auch in Laminat) funktioniert auch als Arbeitstisch, Präsentations- oder Spieloberfläche. Jede Konfiguration besteht aus Holzseiten, Rückwänden, Abdeck- und Bodenplatten, Sockel sowie Beschlagteilen. Lackierte und furnierte Lingo Square haben das FSC Zertifikat. Für Fachböden siehe von Seite 144, für Zubehör siehe von Seite 186.

H920 (939 mm) - für 2 Fachböden

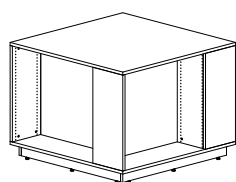

Achismaß mm	FB Tiefe mm	Total Breite mm	Bestell-Nr.	Melamin	Lackiert	Furniert
500	250	811	BBN130352200.	-	-	-
500	300	861	BBN130353200.	-	-	-
750	250	1061	BBN130372200.	-	-	-
750	300	1111	BBN130373200.	-	-	-
900	250	1211	BBN130392200.	-	-	-
900	300	1261	BBN130393200.	-	-	-

H1220 (1239 mm) - für 3 Fachböden

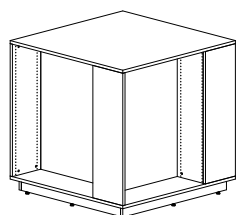

Achismaß mm	FB Tiefe mm	Total Breite mm	Bestell-Nr.	Melamin	Lackiert	Furniert
500	250	811	BBN130452200.	-	-	-
500	300	861	BBN130453200.	-	-	-
750	250	1061	BBN130472200.	-	-	-
750	300	1111	BBN130473200.	-	-	-
900	250	1211	BBN130492200.	-	-	-
900	300	1261	BBN130493200.	-	-	-

H1520 (1539 mm) - für 4 Fachböden

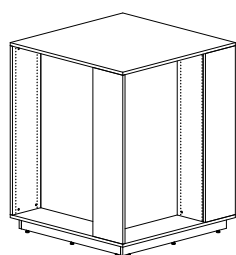

Achismaß mm	FB Tiefe mm	Total Breite mm	Bestell-Nr.	Melamin	Lackiert	Furniert
500	250	811	BBN130552200.	-	-	-
500	300	861	BBN130553200.	-	-	-
750	250	1061	BBN130572200.	-	-	-
750	300	1111	BBN130573200.	-	-	-
900	250	1211	BBN130592200.	-	-	-
900	300	1261	BBN130593200.	-	-	-

H1820 (1839 mm) - für 5 Fachböden

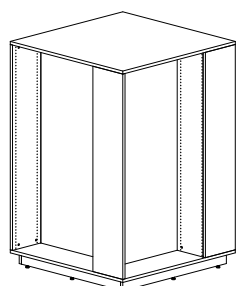

Achismaß mm	FB Tiefe mm	Total Breite mm	Bestell-Nr.	Melamin	Lackiert	Furniert
500	250	811	BBN130652200.	-	-	-
500	300	861	BBN130653200.	-	-	-
750	250	1061	BBN130672200.	-	-	-
750	300	1111	BBN130673200.	-	-	-
900	250	1211	BBN130692200.	-	-	-
900	300	1261	BBN130693200.	-	-	-

LINGO SQUARE



LINGO SQUARE

MIT ROLLEN

Lingo Square kann in verschiedenen Umgebungen für Präsentation, Aufbewahrung, und Ausstellung verwendet werden. Die Abdeckplatte (auch in Laminat) funktioniert auch als Arbeitstisch, Präsentations- oder Spieloberfläche. Jede Konfiguration besteht aus Holzseiten, Rückwänden, Abdeck- und Bodenplatten, der 8 Rollen (Ø75 mm, 2 mit Feststellern) sowie Beschlagteilen. Lackierte und furnierte Lingo Square haben das FSC Zertifikat. Für Fachböden siehe von Seite 144, für Zubehör siehe von Seite 186.

H920 (939 mm) - für 2 Fachböden

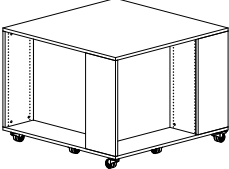
	Achsmaß	FB Tiefe	Total Breite	Bestell-Nr.	Melamin	Lackiert	Furniert
	mm	mm	mm				
	500	250	811	BBN130352100.	-	-	-
	500	300	861	BBN130353100.	-	-	-
	750	250	1061	BBN130372100.	-	-	-
	750	300	1111	BBN130373100.	-	-	-
	900	250	1211	BBN130392100.	-	-	-
	900	300	1261	BBN130393100.	-	-	-

H1220 (1239 mm) - für 3 Fachböden

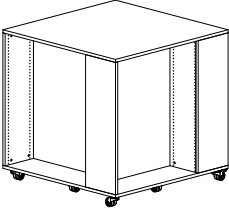
	Achsmaß	FB Tiefe	Total Breite	Bestell-Nr.	Melamin	Lackiert	Furniert
	mm	mm	mm				
	500	250	811	BBN130452100.	-	-	-
	500	300	861	BBN130453100.	-	-	-
	750	250	1061	BBN130472100.	-	-	-
	750	300	1111	BBN130473100.	-	-	-
	900	250	1211	BBN130492100.	-	-	-
	900	300	1261	BBN130493100.	-	-	-

H1520 (1539 mm) - für 4 Fachböden

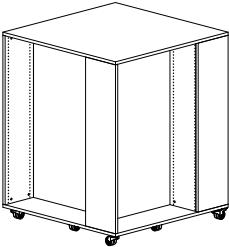
	Achsmaß	FB Tiefe	Total Breite	Bestell-Nr.	Melamin	Lackiert	Furniert
	mm	mm	mm				
	500	250	811	BBN130552100.	-	-	-
	500	300	861	BBN130553100.	-	-	-
	750	250	1061	BBN130572100.	-	-	-
	750	300	1111	BBN130573100.	-	-	-
	900	250	1211	BBN130592100.	-	-	-
	900	300	1261	BBN130593100.	-	-	-

H1820 (1839 mm) - für 5 Fachböden

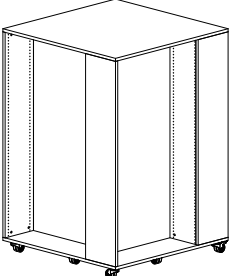
	Achsmaß	FB Tiefe	Total Breite	Bestell-Nr.	Melamin	Lackiert	Furniert
	mm	mm	mm				
	500	250	811	BBN130652100.	-	-	-
	500	300	861	BBN130653100.	-	-	-
	750	250	1061	BBN130672100.	-	-	-
	750	300	1111	BBN130673100.	-	-	-
	900	250	1211	BBN130692100.	-	-	-
	900	300	1261	BBN130693100.	-	-	-



Wenn Sie Ihr eigenes Regal zusammenstellen, gibt es viele Faktoren, die dabei zu berücksichtigen sind. Vor allem müssen Sie auf die Vollständigkeit der Teile achten. Im Folgenden finden Sie eine Checkliste derjenigen Bestandteile, an die Sie beim Aufbau Ihres eigenen Holzregals denken müssen.

FACHBÖDEN (Seite 144)

Die folgenden Faktoren sind dabei zu berücksichtigen, bevor Sie Ihre Fachböden wählen:

- Metall- oder Holzfachboden
- Hängebuchstütze oder Buchstütze an Metallbuchanschlag geführt
- Maximale Belastung
- Verbindung zwischen Holzseiten (Metallrahmentraverse, Holzrückwand oder Diagonalttraverse)
- Abdeckfachboden aus Metall/Holz oder überliegende Holzabdeckplatte

ZUBEHÖR (Seite 186)

- Sie können die Fachböden mit einer Funktion ergänzen oder ersetzen, z.B. Tröge oder Multimedia-Aufbewahrung.

ROLLEN (Seite 207)

Zusätzliche Komponenten für die komplette Funktion und Design des Regals:

- Rollenset
- Rollenplatte
- Sockel

REGALSEITEN (Seite 210)

Die folgenden Faktoren sind dabei zu berücksichtigen, bevor Sie Ihre Holzseiten wählen:

- Design (Standard/mit Rillen – Rillen gibt es für doppelseitige Regale H1520-2120 mm)
- Kapazität (einseitig/doppelseitig)
- Höhe (720/920/1220/1520/1820/2120 mm)
- Tiefe (250/300/400 mm)
- Stationär oder mobil (Stellfüße/Rollenset/Rollenplatte)
- Abdeckboden oder Holzabdeckplatte

VERBINDUNGSELEMENTEN (Seite 224)

Für die Stabilität der Regale und nach Ihrem Wunsch vom Design des Systems, wählen Sie bitte eine der folgenden Verbindungen zwischen den Holzseiten:

- Metallrahmentraverse
- Holzrückwand
- Metalldiagonalttraverse

FACHBÖDEN

S1 & S2 - METALLFACHBÖDEN

Siehe unten eine Übersicht über die Standardfachböden aus Metall:

S1 - METALLFACHBODEN MIT METALLBUCHAN SCHLAG - FÜR BUCHSTÜTZE AN HINTERER AUFKANTUNG

Details:

- Achsmaß 500/750/900/1000 mm
- Tiefe 250/300/400 mm
- Metallbuchanschlag H47 mm
- Buchstütze an Metallbuchanschlag geführt
- Metallkonsole
- Max. Belastung 80 kg.
- Gerade, 45°/60° schräg & 7,5° rückwärts geneigt

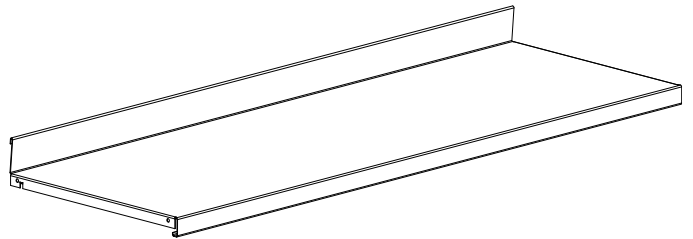

Benutzen mit:

- ST1 - Metallabdeckboden
- WT1 - Holzabdeckboden
- WO1 - Holzabdeckplatte

Beachten:

- Metallfachböden, die ganz unten montiert werden, müssen immer mit den Holzseiten verschraubt werden.
- Bei Regalen H1820 und H2120 mit Diagonaltraverse muß immer 1 Zwischenfachboden mit den Holzseiten verschraubt werden.

S2 - METALLFACHBODEN MIT ACRYLBUCHAN SCHLAG - FÜR HÄNGBUCHSTÜTZE

Details:

- Achsmaß 500/750/900/1000 mm
- Tiefe 250/300/400 mm
- Acrylbuchanschlag H17 mm (separater Teil)
- Hängebuchstütze
- Metallkonsole
- Max. Belastung 80 kg.
- Gerade

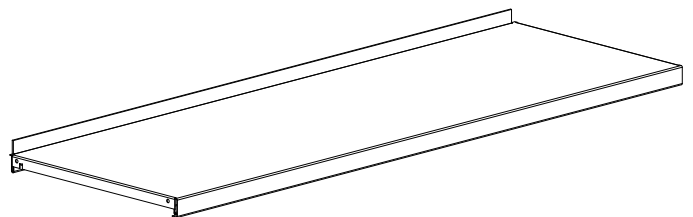

Benutzen mit:

- ST2 - Metallabdeckboden
- WT1 - Holzabdeckboden
- WO1 - Holzabdeckplatte

Beachten:

- Metallfachböden, die ganz unten montiert werden, müssen immer mit den Holzseiten verschraubt werden.
- Bei Regalen H1820 und H2120 mit Diagonaltraverse muß immer 1 Zwischenfachboden mit den Holzseiten verschraubt werden.

Siehe unten eine Übersicht über die Standardfachböden aus Metall:

S3 - METALLFACHBODEN MIT METALLBUCHAN SCHLAG - FÜR HÄNGEBUCHSTÜTZE

Details:

- Achsmaß 500/750/900/1000 mm
- Tiefe 250/300/400 mm
- Metallbuchanschlag H25 mm
- Hängebuchstütze
- Stifte/Schrauben
- Max. Belastung 80 kg.
- Gerade und schräg

Benutzen mit:

- ST3 - Metallabdeckboden
- WT1 - Holzabdeckboden
- WO1 - Holzabdeckplatte

Beachten:

- Metallfachböden, die ganz unten montiert werden, müssen immer mit den Holzseiten verschraubt werden.
- Bei Regalen H1820 und H2120 mit Diagonaltraverse muß immer 1 Zwischenfachboden mit den Holzseiten verschraubt werden.

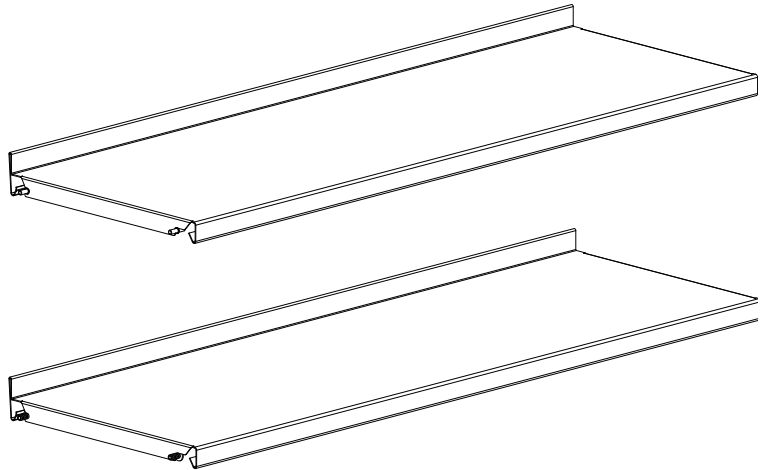

S4 - METALLFACHBODEN OHNE BUCHANSCHLAG - FÜR HÄNGEBUCHSTÜTZE

Details:

- Achsmaß 500/750/900/1000 mm
- Tiefe 250/300/400 mm
- Keine Buchanschlag
- Hängebuchstütze
- Stifte/Schrauben
(Für Diagonaltraverse H1820 und H2120 sind Schrauben zu verwenden.)
- Max. Belastung 80 kg.
- Gerade

Benutzen mit:

- ST3 - Metallabdeckboden
- WT1 - Holzabdeckboden
- WO1 - Holzabdeckplatte

Beachten:

- Metallfachböden, die ganz unten montiert werden, müssen immer mit den Holzseiten verschraubt werden.
- Bei Regalen H1820 und H2120 mit Diagonaltraverse muß immer 1 Zwischenfachboden mit den Holzseiten verschraubt werden.

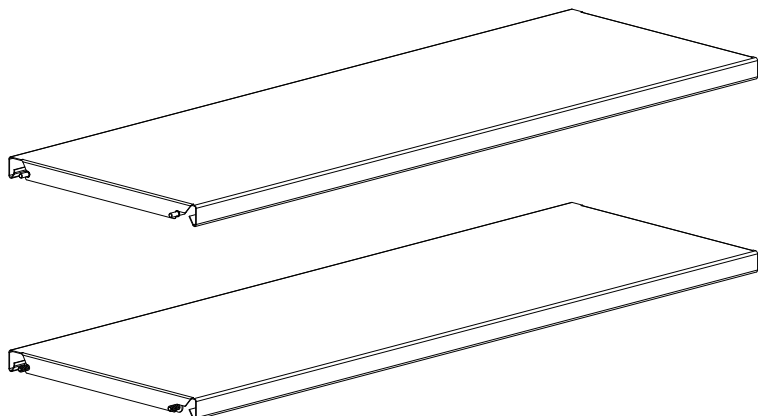

FACHBÖDEN

S1 - METALLFACHBODEN & KOMPONENTEN

S1 - Metallfachboden mit Metallbuchanschlag und Metallkonsole - für Buchstütze an Metallbuchanschlag geführt

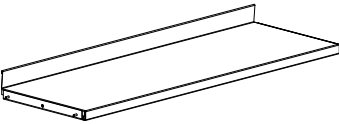
Metallbuchanschlag H47 mm.	Achsmaß mm	FB Tiefe mm	Bestell-Nr.
	500	250	BBN0901152
	500	300	BBN0901153
	500	400	BBN0901154
	750	250	BBN0901172
	750	300	BBN0901173
	750	400	BBN0901174
	900	250	BBN0901192
	900	300	BBN0901193
	900	400	BBN0901194
	1000	250	BBN0901112
	1000	300	BBN0901113
	1000	400	BBN0901114

S1 - Metallfachboden mit Metallvorderkant und 45°/60° Schrägstellkonsole

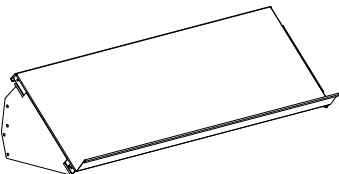
Metallvorderkant H47 mm.	Achsmaß mm	FB Tiefe mm	Bestell-Nr.
	500	250	BBN0901352
	500	300	BBN0901353
	500	400	BBN0901354
	750	250	BBN0901372
	750	300	BBN0901373
	750	400	BBN0901374
	900	250	BBN0901392
	900	300	BBN0901393
	900	400	BBN0901394
	1000	250	BBN0901312
	1000	300	BBN0901313
	1000	400	BBN0901314

S1 - Metallfachboden mit Metallbuchanschlag und 7.5° Schrägstellkonsole rückwärts - für Buchstütze an Buchanschlag geführt

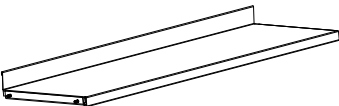
Metallbuchanschlag H47 mm.	Achsmaß mm	FB Tiefe mm	Bestell-Nr.
	500	250	BBN0901252
	500	300	BBN0901253
	500	400	BBN0901254
	750	250	BBN0901272
	750	300	BBN0901273
	750	400	BBN0901274
	900	250	BBN0901292
	900	300	BBN0901293
	900	400	BBN0901294
	1000	250	BBN0901212
	1000	300	BBN0901213
	1000	400	BBN0901214

S1 - Metallfachboden mit Metallbuchanschlag - für Buchstütze an Metallbuchanschlag geführt

Metallbuchanschlag H47 mm.
Konsole sind separat zu bestellen, siehe Seite 150.

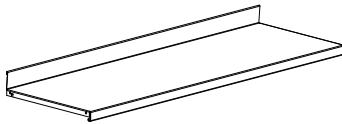

Achsmaß mm	FB Tiefe mm	Bestell-Nr.
500	250	B40110525
500	300	B40110535
500	400	B40110545
750	250	B40100127
750	300	B40100137
750	400	B40100147
900	250	B40100129
900	300	B40100139
900	400	B40100149
1000	250	B40100121
1000	300	B40100131
1000	400	B40100141

Buchstütze an Metallbuchanschlag geführt - for S1

Vernickelt, Ø6 mm, mit
Nylon-Gleiter.

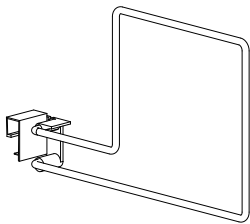

FB Tiefe mm	Bücher auf der linken/rechten Seite der Buchstütze	Bestell-Nr.
250	Links	B4011221
300	Links	B4011222
250/300	Links (hoch)	B4011223
250	Rechts	B4011224
300	Rechts	B4011225

FACHBÖDEN

S2 - METALLFACHBODEN

S2 - Metallfachboden mit Acrylbuchanschlag und Metallkonsole - für Hängebuchstütze

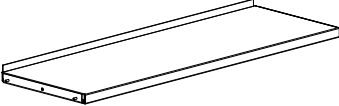
Acrylbuchanschlag 17 mm.	Achsmaß mm	FB Tiefe mm	Bestell-Nr.
	500	250	BBN0902152
	500	300	BBN0902153
	500	400	BBN0902154
	750	250	BBN0902172
	750	300	BBN0902173
	750	400	BBN0902174
	900	250	BBN0902192
	900	300	BBN0902193
	900	400	BBN0902194
	1000	250	BBN0902112
	1000	300	BBN0902113
	1000	400	BBN0902114

S2 - Metallfachboden mit Acrylbuchanschlag und 45°/60° Schrägstellkonsole

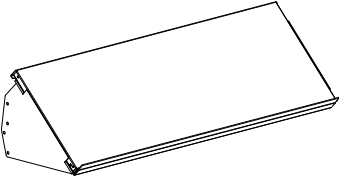
Acrylbuchanschlag 17 mm.	Achsmaß mm	FB Tiefe mm	Bestell-Nr.
	500	250	BBN0902352
	500	300	BBN0902353
	500	400	BBN0902354
	750	250	BBN0902372
	750	300	BBN0902373
	750	400	BBN0902374
	900	250	BBN0902392
	900	300	BBN0902393
	900	400	BBN0902394
	1000	250	BBN0902312
	1000	300	BBN0902313
	1000	400	BBN0902314

S2 - Metallfachboden mit Acrylbuchanschlag und 7.5° Schrägstellkonsole rückwärts

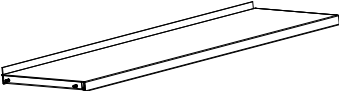
Acrylbuchanschlag 17 mm.	Achsmaß mm	FB Tiefe mm	Bestell-Nr.
	500	250	BBN0902252
	500	300	BBN0902253
	500	400	BBN0902254
	750	250	BBN0902272
	750	300	BBN0902273
	750	400	BBN0902274
	900	250	BBN0902292
	900	300	BBN0902293
	900	400	BBN0902294
	1000	250	BBN0902212
	1000	300	BBN0902213
	1000	400	BBN0902214

S2 - Metallfachboden mit Acrylbuchanschlag - für Hängebuchstütze

Acrylbuchanschlag 17 mm. Konsole sind separat zu bestellen, siehe Seite 150.

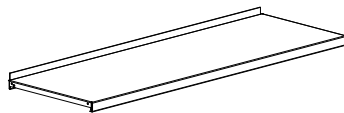

Achsmaß mm	FB Tiefe mm	Bestell-Nr.
500	250	B401106251
500	300	B401106351
500	400	B401106451
750	250	B40101327
750	300	B40101337
750	400	B40101347
900	250	B40101329
900	300	B40101339
900	400	B40101349
1000	250	B40101321
1000	300	B40101331
1000	400	B40101341

Hängebuchstütze - für S2

Erhältlich in verchromtem Metall oder in Standardmetallfarben.

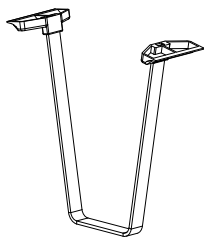

Type	Höhe mm	Bestell-Nr.
Normal	200	B4011242
Folio	250	B4011245

Acrylbuchanschlag - für S2

Ersatzteil. H40 mm, reicht bis 17 mm über Fachbodenoberfläche. Wird mit Metallfachböden mit Buchanschlagleiste aus Acryl geliefert.

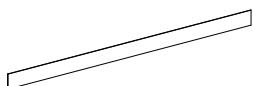

Achsmaß mm	Bestell-Nr.
500	B4010145
750	B4010127
900	B4010129
1000	B4010121

FACHBÖDEN

S1 & S2 - KOMPONENTEN

Metallkonsolen - für S1 & S2

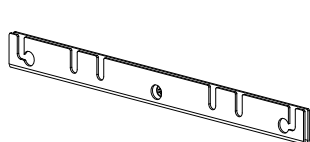

FB Tiefe mm
250
300
400

Bestell-Nr.
BN0842
BN0843
BN0844

45°/60° Schrägstellkonsole - für S1 & S2

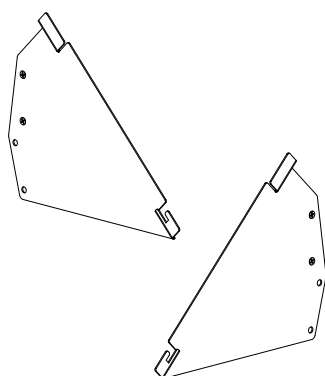

FB Tiefe mm	Type
250	Links
250	Rechts
300	Links
300	Rechts
400	Links
400	Rechts

Bestell-Nr.
BN08828
BN08829
BN08838
BN08839
BN08848
BN08849

7.5° Schrägstellkonsole rückwärts - für S1 & S2

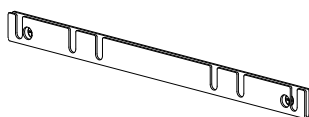

FB Tiefe mm
250
300
400

Bestell-Nr.
BN0862
BN0863
BN0864

FACHBÖDEN

S3 - METALLFACHBODEN

S3 - Metallfachboden mit Metallbuchanschlag und Stifte - für Hängebuchstütze

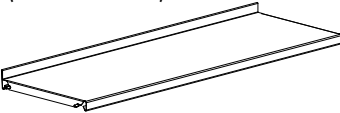
Metallbuchanschlag H25 mm. Als Schrägfachboden durch Umdrehen und unter Verwendung der vorhandenen Stifte und Konsole BN066 verwendbar (siehe Seite 153).	Achsmaß mm	FB Tiefe mm	Bestell-Nr.
	500	250	BN0655214
	500	300	BN0655314
	500	400	BN0655414
	750	250	BN0657214
	750	300	BN0657314
	750	400	BN0657414
	900	250	BN0659214
	900	300	BN0659314
	900	400	BN0659414
	1000	250	BN0651214
	1000	300	BN0651314
	1000	400	BN0651414

S3 - Metallfachboden mit Metallbuchanschlag, Schrauben und Distanzhaltern - für Hängebuchstütze

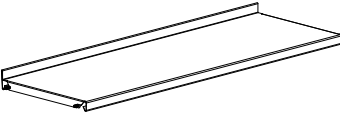
Metallbuchanschlag H25 mm.	Achsmaß mm	FB Tiefe mm	Bestell-Nr.
	500	250	BN0655215
	500	300	BN0655315
	500	400	BN0655415
	750	250	BN0657215
	750	300	BN0657315
	750	400	BN0657415
	900	250	BN0659215
	900	300	BN0659315
	900	400	BN0659415
	1000	250	BN0651215
	1000	300	BN0651315
	1000	400	BN0651415

S3 - Metallfachboden mit Metallbuchanschlag, Auflagestiften und Konsolen für Schrägfachboden

Metallbuchanschlag H25 mm.	Achsmaß mm	FB Tiefe mm	Bestell-Nr.
	500	250	BBN0903352
	500	300	BBN0903353
	500	400	BBN0903354
	750	250	BBN0903372
	750	300	BBN0903373
	750	400	BBN0903374
	900	250	BBN0903392
	900	300	BBN0903393
	900	400	BBN0903394
	1000	250	BBN0903312
	1000	300	BBN0903313
	1000	400	BBN0903314

Hängebuchstütze - für S3, S4 & ST3

Rundstahl verchromt mit bruch-sicheren Kunststoffgleitern. Zum Einhängen in Metallfachböden. Beliebig verstellbar.

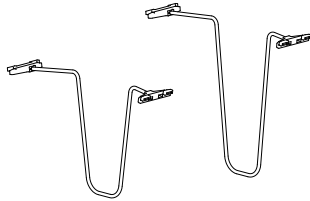

Höhe mm	FB Tiefe mm
220	250
220	300
280	250
280	300

Bestell-Nr.

B40553032
B40553033

B40553062
B40553063

Schrägstellbügel für Fachböden mit Buchanschlag - für S3

Rundstahl, verchromt. Der Nei-gungswinkel ist verstellbar, wir empfehlen eine 45°-Neigung. Pro Fachboden werden zwei Schrägstellbügel benötigt.

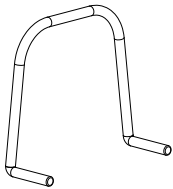

Bestell-Nr.

BN066

FACHBÖDEN

S4 - METALLFACHBODEN & KOMPONENTEN

S4 - Metallfachboden mit Auflagestiften - für Hängebuchstütze

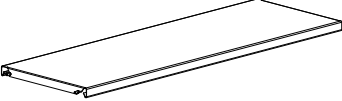
Mit Auflagestifte.	Achs- maß mm	FB Tiefe mm	Bestell-Nr.
	500	250	BN0655204
	500	300	BN0655304
	500	400	BN0655404
	750	250	BN0657204
	750	300	BN0657304
	750	400	BN0657404
	900	250	BN0659204
	900	300	BN0659304
	900	400	BN0659404
	1000	250	BN0651204
	1000	300	BN0651304
	1000	400	BN0651404

S4 - Metallfachboden mit Schrauben und Distanzhaltern - für Hängebuchstütze

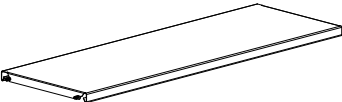
Mit Schrauben.	Achs- maß mm	FB Tiefe mm	Bestell-Nr.
	500	250	BN0655205
	500	300	BN0655305
	500	400	BN0655405
	750	250	BN0657205
	750	300	BN0657305
	750	400	BN0657405
	900	250	BN0659205
	900	300	BN0659305
	900	400	BN0659405
	1000	250	BN0651205
	1000	300	BN0651305
	1000	400	BN0651405

Hängebuchstütze - für S3, S4 & ST3

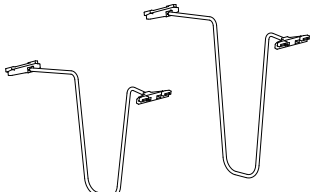
Rundstahl verchromt mit bruch- sicheren Kunststoffgleitern. Zum Einhängen in Metallfachböden. Beliebig verstellbar.	Höhe mm	FB Tiefe mm	Bestell-Nr.
	220	250	B40553032
	220	300	B40553033
	280	250	B40553062
	280	300	B40553063

FACHBÖDEN

ST1 & ST2 - METALLABDECKBÖDEN

Wählen Sie einen Abdeckboden aus Metall oder Holz (zur Montage zwischen den Holzseiten) oder eine überliegende Holzabdeckplatte (zur Montage über den Holzseiten).

ST1 - METALLABDECKBODEN

Details:

- Achsmaß 500/750/900/1000 mm
- Tiefe 250/300/400 mm
- Einseitig Standardtiefe/einseitig Volltiefe /doppelseitig
- Mit 25/47 mm Vorderkant
- Konsole und Schrauben
- Max. Belastung 25 kg.

Benutzen mit:

- S1 - Metallfachboden für Buchstütze an Buchanschlag geführt
- WP1/2/5/6 - Holzseite für Abdeckboden
- WBP1/WBP3 - Holzrückwand für ST1 Standardtiefe
- WBP2/WBP4 - Holzrückwand für ST1 Volltiefe
- WBP2/WBP4 - Holzrückwand für ST1 Doppelseitig

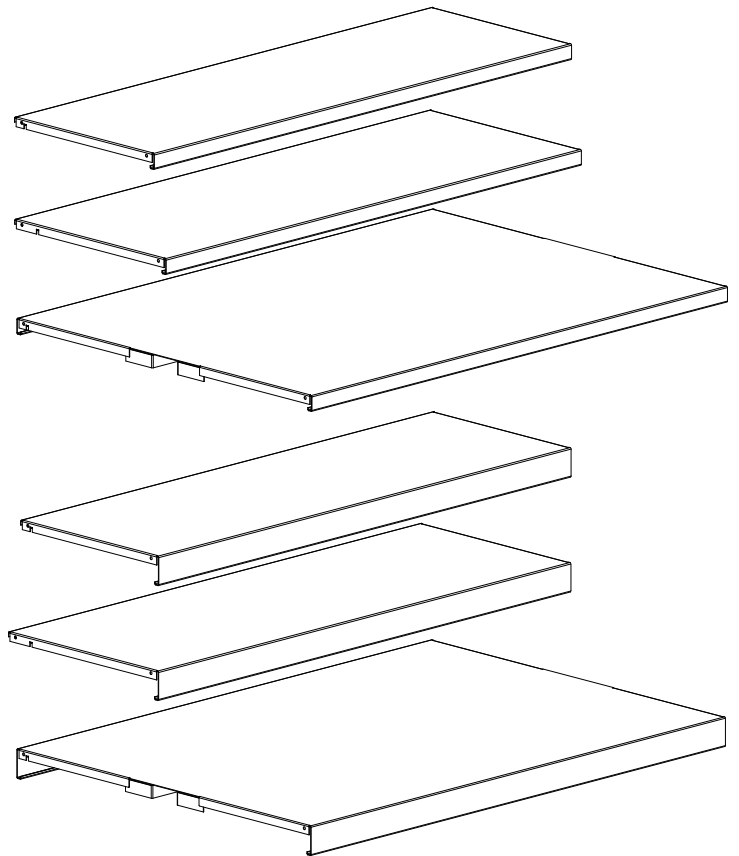

ST2 - METALLABDECKBODEN

Details:

- Achsmaß 500/750/900/1000 mm
- Tiefe 250/300/400 mm
- Einseitig
- Mit H25 mm Vorderkant
- Konsole und Schrauben
- Hängebuchstütze
- Max. Belastung 80 kg

Benutzen mit:

- S2 - Metallfachboden für Hängebuchstütze
- WP1/2/5/6 - Holzseite für Abdeckboden
- WBP1/3 - Holzrückwand für Abdeckboden

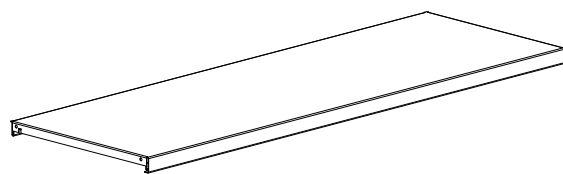

Wählen Sie einen Abdeckboden aus Metall oder Holz (zur Montage zwischen den Holzseiten) oder eine überliegende Holzabdeckplatte (zur Montage über den Holzseiten).

ST3 - METALLABDECKBODEN

Details:

- Achsmaß 500/750/900/1000 mm
- Tiefe 250/300/400 mm
- Einseitig
- Mit H25 mm Vorderkant und 50 mm Beschriftungsschild
- Schrauben und Distanzhalter
- Hängebuchstütze
- Max. Belastung 80 kg.

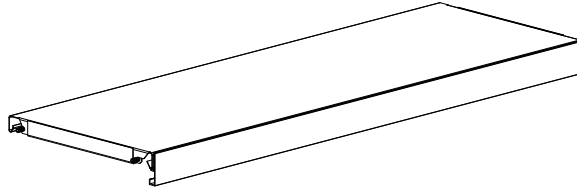

Benutzen mit:

- S3 - Metallfachboden für Hängebuchstütze
- WP1/2/5/6 - Holzseite für Abdeckboden
- WBP1/3 - Holzrückwand für Abdeckboden

FACHBÖDEN

ST1 - METALLABDECKBODEN MIT H25 MM VORDERKANT UND KONSOLE

ST1 - Einseitig Metallabdeckboden mit H25 mm Vorderkant und Konsole - Standardtiefe

Benützen mit S1.	Achsmaß mm	FB Tiefe mm	Bestell-Nr.
	500	250	BBN086152
	500	300	BBN086153
	500	400	BBN086154
	750	250	BBN086172
	750	300	BBN086173
	750	400	BBN086174
	900	250	BBN086192
	900	300	BBN086193
	900	400	BBN086194
	1000	250	BBN086112
	1000	300	BBN086113
	1000	400	BBN086114

ST1 - Einseitig Metallabdeckboden mit H25 mm Vorderkant und Konsole - Volltiefe

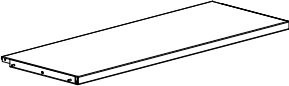
Benützen mit S1. Nur für einseitige Regalsystem.	Achsmaß mm	FB Tiefe mm	Bestell-Nr.
	500	250	BBN086352
	500	300	BBN086353
	500	400	BBN086354
	750	250	BBN086372
	750	300	BBN086373
	750	400	BBN086374
	900	250	BBN086392
	900	300	BBN086393
	900	400	BBN086394
	1000	250	BBN086312
	1000	300	BBN086313
	1000	400	BBN086314

ST1 - Doppelseitig Metallabdeckboden mit H25 mm Vorderkant und Konsole

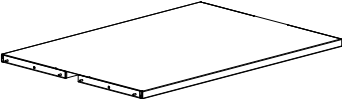
Benützen mit S1.	Achsmaß mm	FB Tiefe mm	Bestell-Nr.
	500	250	BBN086552
	500	300	BBN086553
	500	400	BBN086554
	750	250	BBN086572
	750	300	BBN086573
	750	400	BBN086574
	900	250	BBN086592
	900	300	BBN086593
	900	400	BBN086594
	1000	250	BBN086512
	1000	300	BBN086513
	1000	400	BBN086514

ST1 - Einseitig Metallabdeckboden mit H25 mm Vorderkant - Standardtiefe

Konsole sind separat zu bestellen, siehe Seite 125. Benützen mit S1.

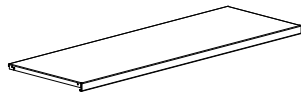

Achsmaß mm	FB Tiefe mm	Bestell-Nr.
500	250	BN080522518
500	300	BN080532518
500	400	BN080542518
750	250	BN080722518
750	300	BN080732518
750	400	BN080742518
900	250	BN080922518
900	300	BN080932518
900	400	BN080942518
1000	250	BN080122518
1000	300	BN080132518
1000	400	BN080142518

ST1 - Einseitig Metallabdeckboden mit H25 mm Vorderkant - Volltiefe

Konsole sind separat zu bestellen, siehe Seite 125. Benützen mit S1. Nur für einseitige Regalsystem.

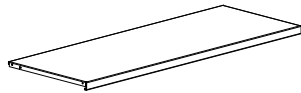

Achsmaß mm	FB Tiefe mm	Bestell-Nr.
500	250	BN080522519
500	300	BN080532519
500	400	BN080542519
750	250	BN080722519
750	300	BN080732519
750	400	BN080742519
900	250	BN080922519
900	300	BN080932519
900	400	BN080942519
1000	250	BN080122519
1000	300	BN080132519
1000	400	BN080142519

ST1 - Doppelseitig Metallabdeckboden mit H25 mm Vorderkant

Konsole sind separat zu bestellen, siehe Seite 125. Benützen mit S1.

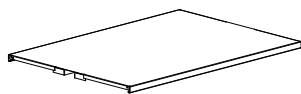

Achsmaß mm	FB Tiefe mm	Bestell-Nr.
500	250	BN080522528
500	300	BN080532528
500	400	BN080542528
750	250	BN080722528
750	300	BN080732528
750	400	BN080742528
900	250	BN080922528
900	300	BN080932528
900	400	BN080942528
1000	250	BN080122528
1000	300	BN080132528
1000	400	BN080142528

FACHBÖDEN

ST1 - METALLABDECKBODEN MIT H47 MM VORDERKANT UND KONSOLE

ST1 - Einseitig Metallabdeckboden mit H47 mm Vorderkant und Konsole - Standardtiefe

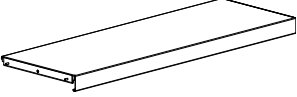
Benützen mit S1.	Achsmaß mm	FB Tiefe mm	Bestell-Nr.
	500	250	BBN086252
	500	300	BBN086253
	500	400	BBN086254
	750	250	BBN086272
	750	300	BBN086273
	750	400	BBN086274
	900	250	BBN086292
	900	300	BBN086293
	900	400	BBN086294
	1000	250	BBN086212
	1000	300	BBN086213
	1000	400	BBN086214

ST1 - Einseitig Metallabdeckboden mit H47 mm Vorderkant und Konsole - Volltiefe

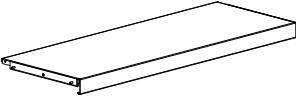
Benützen mit S1. Nur für einseitige Regalsystem.	Achsmaß mm	FB Tiefe mm	Bestell-Nr.
	500	250	BBN086452
	500	300	BBN086453
	500	400	BBN086454
	750	250	BBN086472
	750	300	BBN086473
	750	400	BBN086474
	900	250	BBN086492
	900	300	BBN086493
	900	400	BBN086494
	1000	250	BBN086412
	1000	300	BBN086413
	1000	400	BBN086414

ST1 - Doppelseitig Metallabdeckboden mit H47 mm Vorderkant und Konsole

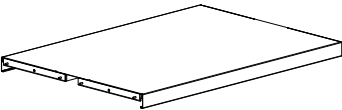
Benützen mit S1.	Achsmaß mm	FB Tiefe mm	Bestell-Nr.
	500	250	BBN086652
	500	300	BBN086653
	500	400	BBN086654
	750	250	BBN086672
	750	300	BBN086673
	750	400	BBN086674
	900	250	BBN086692
	900	300	BBN086693
	900	400	BBN086694
	1000	250	BBN086612
	1000	300	BBN086613
	1000	400	BBN086614

ST1 - Einseitig Metallabdeckboden mit H47 mm Vorderkant - Standardtiefe

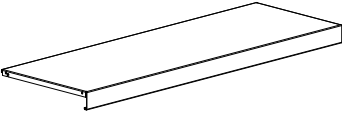
Konsole sind separat zu bestellen, siehe Seite 125. Benützen mit S1.	Achsmaß mm	FB Tiefe mm	Bestell-Nr.
	500	250	BN080524718
	500	300	BN080534718
	500	400	BN080544718
	750	250	BN080724718
	750	300	BN080734718
	750	400	BN080744718
	900	250	BN080924718
	900	300	BN080934718
	900	400	BN080944718
	1000	250	BN080124718
	1000	300	BN080134718
	1000	400	BN080144718

ST1 - Einseitig Metallabdeckboden mit H47 mm Vorderkant - Volltiefe

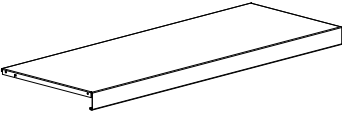
Konsole sind separat zu bestellen, siehe Seite 125. Benützen mit S1. Nur für einseitige Regalsystem.	Achsmaß mm	FB Tiefe mm	Bestell-Nr.
	500	250	BN080524719
	500	300	BN080534719
	500	400	BN080544719
	750	250	BN080724719
	750	300	BN080734719
	750	400	BN080744719
	900	250	BN080924719
	900	300	BN080934719
	900	400	BN080944719
	1000	250	BN080124719
	1000	300	BN080134719
	1000	400	BN080144719

ST1 - Doppelseitig Metallabdeckboden mit H47 mm Vorderkant

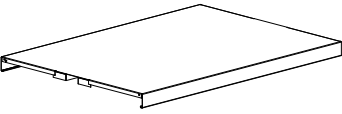
Konsole sind separat zu bestellen, siehe Seite 125. Benützen mit S1.	Achsmaß mm	FB Tiefe mm	Bestell-Nr.
	500	250	BN080524728
	500	300	BN080534728
	500	400	BN080544728
	750	250	BN080724728
	750	300	BN080734728
	750	400	BN080744728
	900	250	BN080924728
	900	300	BN080934728
	900	400	BN080944728
	1000	250	BN080124728
	1000	300	BN080134728
	1000	400	BN080144728

FACHBÖDEN

ST2 - METALLABDECKBODEN & KOMPONENTEN

ST2 - Einseitig Metallabdeckboden mit Konsole - in Einlegebodentiefe - für Hängebuchstütze

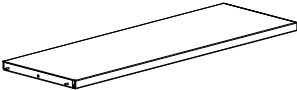
Benützen mit S2.	Achsmaß mm	FB Tiefe mm	Bestell-Nr.
	500	250	BBN086752
	500	300	BBN086753
	500	400	BBN086754
	750	250	BBN086772
	750	300	BBN086773
	750	400	BBN086774
	900	250	BBN086792
	900	300	BBN086793
	900	400	BBN086794
	1000	250	BBN086712
	1000	300	BBN086713
	1000	400	BBN086714

ST2 - Einseitig Metallabdeckboden - in Einlegebodentiefe - für Hängebuchstütze

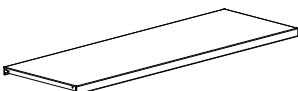
Konsole sind separat zu bestellen, siehe Seite 125. Benützen mit S2.	Achsmaß mm	FB Tiefe mm	Bestell-Nr.
	500	250	B401106250
	500	300	B401106350
	500	400	B401106450
	750	250	B40101127
	750	300	B40101137
	750	400	B40101147
	900	250	B40101129
	900	300	B40101139
	900	400	B40101149
	1000	250	B40101121
	1000	300	B40101131
	1000	400	B40101141

Hängebuchstütze - für S2 & ST2

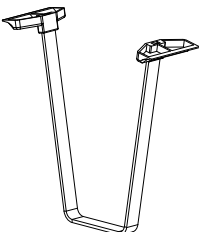
Erhältlich in verchromtem Stahl oder Standard Metallfarben.	Type	Höhe mm	Bestell-Nr.
	Normal	200	B4011242
	Folio	250	B4011245

Metallkonsol - für ST1 & ST2

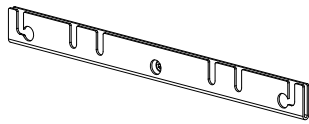

FB Tiefe
mm

250
300
400

Bestell-Nr.

BN0842
BN0843
BN0844

Fachbodenbrücke - für ST1 & ST2

Zur Minimierung der Fuge
zwischen Abdeckböden ST1/
ST2 auf doppelseitig
Regal.



Fachboden

Achismaß
mm

Bestell-Nr.

ST1 25 mm
ST1 25 mm
ST1 25 mm
ST1 25 mm

500
750
900
1000

BN04015
BN04017
BN04019
BN04011

ST1 47 mm
ST1 47 mm
ST1 47 mm
ST1 47 mm

500
750
900
1000

BN04025
BN04027
BN04029
BN04021

ST2
ST2
ST2
ST2

500
750
900
1000

BN04075
BN04077
BN04079
BN04071

FACHBÖDEN

ST3 - METALLABDECKBODEN MIT BESCHRIFTUNGSSCHILD & KOMPONENTEN

ST3 - Einseitig Metallabdeckboden mit Schrauben, Distanzhaltern und Beschriftungsschild - für Hängebuchstütze

H50 mm Beschriftungsschild. Benützen mit S3 und S4.	Achsmaß mm	FB Tiefe mm	Bestell-Nr.
	500	250	BBN08452
	500	300	BBN08453
	500	400	BBN08454
	750	250	BBN08472
	750	300	BBN08473
	750	400	BBN08474
	900	250	BBN08492
	900	300	BBN08493
	900	400	BBN08494
	1000	250	BBN08412
	1000	300	BBN08413
	1000	400	BBN08414

S4 - Einseitig Metallabdeckboden mit Schrauben und Distanzhaltern - in Einlegebodentiefe - für Hängebuchstütze

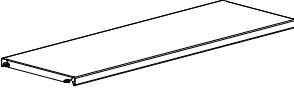
Metallfachboden kann als Abdeckboden benutzt werden.	Achsmaß mm	FB Tiefe mm	Bestell-Nr.
	500	250	BN0655205
	500	300	BN0655305
	500	400	BN0655405
	750	250	BN0657205
	750	300	BN0657305
	750	400	BN0657405
	900	250	BN0659205
	900	300	BN0659305
	900	400	BN0659405
	1000	250	BN0651205
	1000	300	BN0651305
	1000	400	BN0651405

Hängebuchstütze - für S3, S4 & ST3

Rundstahl verchromt mit bruch-sicheren Kunststoffgleitern. Zum Einhängen in Metallfachböden. Beliebig verstellbar.	Höhe mm	FB Tiefe mm	Bestell-Nr.
	220	250	B40553032
	220	300	B40553033
	280	250	B40553062
	280	300	B40553063

FACHBÖDEN

W1 & W2 - HOLZFACHBÖDEN

Siehe unten eine Übersicht über die Standardfachböden aus Holz:

W1 - HOLZFACHBODEN MIT H47 MM METALLBUCHAN SCHLAG - FÜR BUCHSTÜTZE AN BUCHANSCHLAG GEFÜHRT

Details:

- Achsmaß 500/750/900 mm
- Tiefe 250/300/400 mm
- Lackiert/furniert
- Metallbuchanschlag H47 mm für Buchstütze an Buchanschlag geführt
- Snapfix/Snapfix und Schrauben
- Max. Belastung 80 kg.
- Tischlerplatte
- Gerade

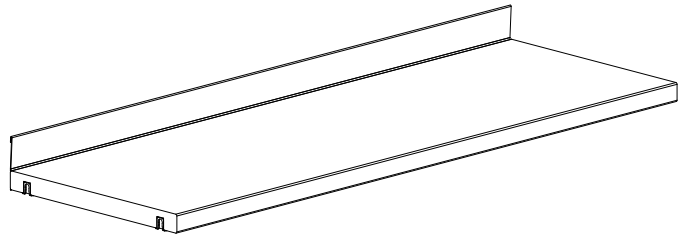

Benutzen mit:

- S1 - Metallfachboden
- ST1 - Metallabdeckboden
- WT1 - Holzabdeckboden
- WO1 - Holzabdeckplatte

Beachten:

- Holzfachböden, die ganz am unten montiert werden, müssen immer mit den Holzseiten verschraubt werden (Snapfix/Schrauben).
 - Bei Regalen H1820 und H2120 mit Diagonaltraverse muß immer 1 Zwischenfachboden mit den Holzseiten verschraubt werden (Snapfix/Schrauben).
-

W2 - HOLZFACHBODEN

Details:

- Achsmaß 500/750/900 mm
- Tiefe 250/300/400 mm
- Lackiert/furniert
- Ohne Buchanschlag
- Snapfix/Snapfix und Schrauben
- Max. Belastung 80 kg.
- Tischlerplatte
- Gerade

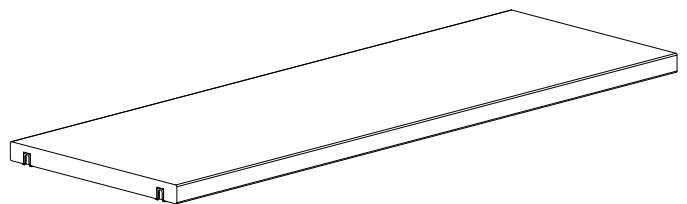

Benutzen mit:

- S2 - Metallfachboden
- ST2 - Metallabdeckboden
- WT1 - Holzabdeckboden
- WO1 - Holzabdeckplatte

Beachten:

- Holzfachböden, die ganz am unten montiert werden, müssen immer mit den Holzseiten verschraubt werden (Snapfix/Schrauben).
 - Bei Regalen H1820 und H2120 mit Diagonaltraverse muß immer 1 Zwischenfachboden mit den Holzseiten verschraubt werden (Snapfix/Schrauben).
-

Siehe unten eine Übersicht über die Standardfachböden aus Holz:

W3 - HOLZFACHBODEN MIT H47 MM METALLBUCHAN SCHLAG

Details:

- Achsmaß 500/750/900/1000 mm
- Tiefe 250/300/400 mm
- Melamin/Laminat
- Metallbuchanschlag H47 mm
- Mit/ohne Nut für Beschriftungsschild
- Snapfix/Snapfix und Schrauben
- Max. Belastung 60 kg.
- Spanplatte/Tischlerplatte
- Gerade

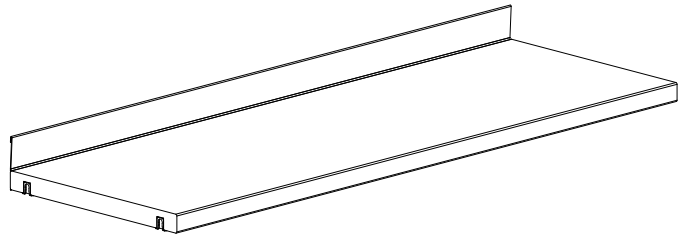

Benutzen mit:

- S3/S4 - Metallfachböden
- ST3 - Metallabdeckboden
- WT1 - Holzabdeckboden
- WO1 - Holzabdeckplatte

Beachten:

- Holzfachböden, die ganz am unten montiert werden, müssen immer mit den Holzseiten verschraubt werden (Snapfix/Schrauben).
- Bei Regalen H1820 und H2120 mit Diagonaltraverse muß immer 1 Zwischenfachboden mit den Holzseiten verschraubt werden (Snapfix/Schrauben).

W4 - HOLZFACHBODEN

Details:

- Achsmaß 500/750/900/1000 mm
- Tiefe 250/300/400 mm
- Melamin/Laminat
- Ohne Buchanschlag
- Mit/ohne Nut für Beschriftungsschild
- Snapfix/Snapfix und Schrauben
- Max. Belastung 60 kg.
- Spanplatte/Tischlerplatte
- Gerade

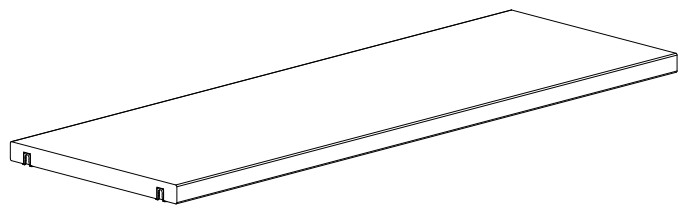

Benutzen mit:

- S3/S4 - Metallfachboden
- ST3 - Metallabdeckboden
- WT1 - Holzabdeckboden
- WO1 - Holzabdeckplatte

Beachten:

- Holzfachböden, die ganz am unten montiert werden, müssen immer mit den Holzseiten verschraubt werden (Snapfix/Schrauben).
- Bei Regalen H1820 und H2120 mit Diagonaltraverse muß immer 1 Zwischenfachboden mit den Holzseiten verschraubt werden (Snapfix/Schrauben).

FACHBÖDEN

W1 - HOLZFACHBODEN MIT H47 MM BUCHANSCHLAG UND KOMPONENTEN

Lackierte und furnierte Lingo Holzfachböden haben das FSC Zertifikat.

W1 - Holzfachboden mit Metallbuchanschlag und Snapfix - für Buchstütze an Buchanschlag geführt

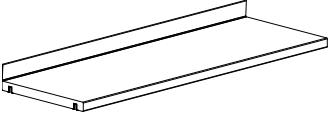
H47 mm Metallbuchanschlag. Tischlerplatte. Mit Beschlägen (Snapfix).	Achsmaß mm	FB Tiefe mm	Bestell-Nr.	Lackiert	Furniert
	500	250	BN067521.ZZZZZZZZ3	-	-
	500	300	BN067531.ZZZZZZZZ3	-	-
	500	400	BN067541.ZZZZZZZZ3	-	-
	750	250	BN067721.ZZZZZZZZ3	-	-
	750	300	BN067731.ZZZZZZZZ3	-	-
	750	400	BN067741.ZZZZZZZZ3	-	-
	900	250	BN067921.ZZZZZZZZ3	-	-
	900	300	BN067931.ZZZZZZZZ3	-	-
	900	400	BN067941.ZZZZZZZZ3	-	-

W1 - Holzfachboden mit Metallbuchanschlag, Snapfix und Schrauben - für Buchstütze an Buchanschlag geführt

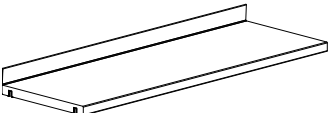
H47 mm Metallbuchanschlag. Tischlerplatte. Mit Beschlägen (Snapfix and Schrauben).	Achsmaß mm	FB Tiefe mm	Bestell-Nr.	Lackiert	Furniert
	500	250	BN067521.ZZZZZZZZ2	-	-
	500	300	BN067531.ZZZZZZZZ2	-	-
	500	400	BN067541.ZZZZZZZZ2	-	-
	750	250	BN067721.ZZZZZZZZ2	-	-
	750	300	BN067731.ZZZZZZZZ2	-	-
	750	400	BN067741.ZZZZZZZZ2	-	-
	900	250	BN067921.ZZZZZZZZ2	-	-
	900	300	BN067931.ZZZZZZZZ2	-	-
	900	400	BN067941.ZZZZZZZZ2	-	-

Buchstütze an Metallbuchanschlag geführt - für W1

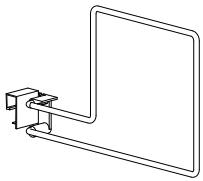
Vernickelt, Ø6 mm, mit Nylon-Gleiter.	FB Tiefe mm	Bücher auf der linken/rechten Seite der Buchstütze	Bestell-Nr.
	250	Links	B4011221
	300	Links	B4011222
	250/300	Links (hoch)	B4011223
	250	Rechts	B4011224
	300	Rechts	B4011225

Lackierte und furnierte Lingo Holzfachböden haben das FSC Zertifikat.

W2 - Holzfachboden ohne Buchanschlag, mit Snapfix

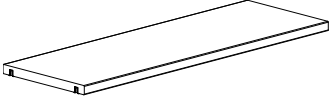
Tischlerplatte. Mit Beschlägen (Snapfix).	Achsmaß mm	FB Tiefe mm	Bestell-Nr.	Lackiert	Furniert
	500	250	BN067520.ZZZZZZZZ3	-	-
	500	300	BN067530.ZZZZZZZZ3	-	-
	500	400	BN067540.ZZZZZZZZ3	-	-
	750	250	BN067720.ZZZZZZZZ3	-	-
	750	300	BN067730.ZZZZZZZZ3	-	-
	750	400	BN067740.ZZZZZZZZ3	-	-
	900	250	BN067920.ZZZZZZZZ3	-	-
	900	300	BN067930.ZZZZZZZZ3	-	-
	900	400	BN067940.ZZZZZZZZ3	-	-

W2 - Holzfachboden ohne Buchanschlag, mit Snapfix und Schrauben

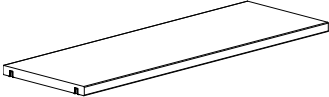
Tischlerplatte. Mit Beschlägen (Snapfix und Schrauben).	Achsmaß mm	FB Tiefe mm	Bestell-Nr.	Lackiert	Furniert
	500	250	BN067520.ZZZZZZZZ2	-	-
	500	300	BN067530.ZZZZZZZZ2	-	-
	500	400	BN067540.ZZZZZZZZ2	-	-
	750	250	BN067720.ZZZZZZZZ2	-	-
	750	300	BN067730.ZZZZZZZZ2	-	-
	750	400	BN067740.ZZZZZZZZ2	-	-
	900	250	BN067920.ZZZZZZZZ2	-	-
	900	300	BN067930.ZZZZZZZZ2	-	-
	900	400	BN067940.ZZZZZZZZ2	-	-

Hängebuchstütze - für S2 und W2/4 mit Schiene

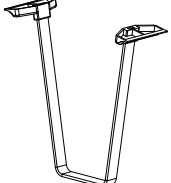
Erhältlich in verchromtem Metall oder in Standardmetallfarben	Type	Höhe mm	Bestell-Nr.
	Normal	200	B4011242
	Folio	250	B4011245

Schiene für Hängebuchstütze unter Holzfachböden W2 & W4

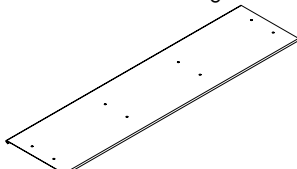
Zur Montage unter Holzfachböden. Für Hängebuchstütze B40112x. Mit Beschlägen.	Achsmaß mm	Bestell-Nr.
	750	B4022007
	900	B4022009

FACHBÖDEN

W3 - HOLZFACHBODEN MIT H47 MM BUCHANSCHLAG

W3 - Holzfachboden mit Metallbuchanschlag und Snapfix, ohne Nut für Beschriftungsschild

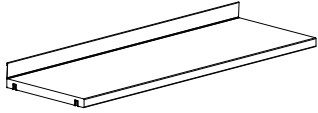
H47 mm Metallbuchanschlag. Spanplatte. Mit Beschlägen (Snapfix).	Achsmaß mm	FB Tiefe mm	Bestell-Nr.	Melamin
	500	250	BN07052106ZZZZZ3	-
	500	300	BN07053106ZZZZZ3	-
	500	400	BN07054106ZZZZZ3	-
	750	250	BN07072106ZZZZZ3	-
	750	300	BN07073106ZZZZZ3	-
	750	400	BN07074106ZZZZZ3	-
	900	250	BN07092106ZZZZZ3	-
	900	300	BN07093106ZZZZZ3	-
	900	400	BN07094106ZZZZZ3	-

W3 - Holzfachboden mit Metallbuchanschlag und Snapfix, ohne Nut für Beschriftungsschild

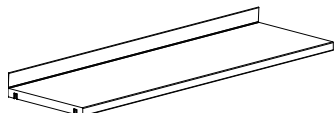
H47 mm Metallbuchanschlag. Tischlerplatte. Mit Beschlägen (Snapfix).	Achsmaß mm	FB Tiefe mm	Bestell-Nr.	Laminat
	1000	250	BN07012103ZZZZZ3	-
	1000	300	BN07013103ZZZZZ3	-
	1000	400	BN07014103ZZZZZ3	-

W3 - Holzfachboden mit Metallbuchanschlag, Snapfix und Nut für Beschriftungsschild

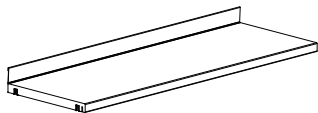
H47 mm Metallbuchanschlag. Spanplatte. Mit Beschlägen (Snapfix).	Achsmaß mm	FB Tiefe mm	Bestell-Nr.	Melamin
	500	250	BN07052116ZZZZZ3	-
	500	300	BN07053116ZZZZZ3	-
	500	400	BN07054116ZZZZZ3	-
	750	250	BN07072116ZZZZZ3	-
	750	300	BN07073116ZZZZZ3	-
	750	400	BN07074116ZZZZZ3	-
	900	250	BN07092116ZZZZZ3	-
	900	300	BN07093116ZZZZZ3	-
	900	400	BN07094116ZZZZZ3	-

W3 - Holzfachboden mit Metallbuchanschlag, Snapfix und Nut für Beschriftungsschild

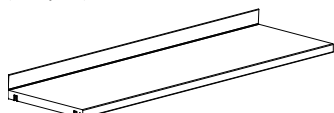
H47 mm Metallbuchanschlag. Tischlerplatte. Mit Beschlägen (Snapfix).	Achsmaß mm	FB Tiefe mm	Bestell-Nr.	Laminat
	1000	250	BN07012113ZZZZZ3	-
	1000	300	BN07013113ZZZZZ3	-
	1000	400	BN07014113ZZZZZ3	-

W3 - Holzfachboden mit Metallbuchanschlag, Snapfix und Schrauben, ohne Nut für Beschriftungsschild

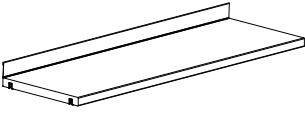
H47 mm Metallbuchanschlag. Spanplatte. Mit Beschlägen (Snapfix und Schrauben).	Achsmaß mm	FB Tiefe mm	Bestell-Nr.	Melamin
	500	250	BN07052106ZZZZZZ2	-
	500	300	BN07053106ZZZZZZ2	-
	500	400	BN07054106ZZZZZZ2	-
	750	250	BN07072106ZZZZZZ2	-
	750	300	BN07073106ZZZZZZ2	-
	750	400	BN07074106ZZZZZZ2	-
	900	250	BN07092106ZZZZZZ2	-
	900	300	BN07093106ZZZZZZ2	-
	900	400	BN07094106ZZZZZZ2	-

W3 - Holzfachboden mit Metallbuchanschlag, Snapfix und Schrauben, ohne Nut für Beschriftungsschild

H47 mm Metallbuchanschlag. Tischlerplatte. Mit Beschlägen (Snapfix und Schrauben).	Achsmaß mm	FB Tiefe mm	Bestell-Nr.	Laminate
	1000	250	BN07012103ZZZZZZ2	-
	1000	300	BN07013103ZZZZZZ2	-
	1000	400	BN07014103ZZZZZZ2	-

W3 - Holzfachboden mit Metallbuchanschlag, Snapfix, Schrauben und Nut für Beschriftungsschild

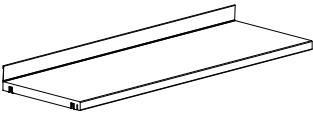
H47 mm Metallbuchanschlag. Spanplatte. Mit Beschlägen (Snapfix und Schrauben).	Achsmaß mm	FB Tiefe mm	Bestell-Nr.	Melamin
	500	250	BN07052116ZZZZZZ2	-
	500	300	BN07053116ZZZZZZ2	-
	500	400	BN07054116ZZZZZZ2	-
	750	250	BN07072116ZZZZZZ2	-
	750	300	BN07073116ZZZZZZ2	-
	750	400	BN07074116ZZZZZZ2	-
	900	250	BN07092116ZZZZZZ2	-
	900	300	BN07093116ZZZZZZ2	-
	900	400	BN07094116ZZZZZZ2	-

W3 - Holzfachboden mit Metallbuchanschlag, Snapfix, Schrauben und Nut für Beschriftungsschild

H47 mm Metallbuchanschlag. Tischlerplatte. Mit Beschlägen (Snapfix und Schrauben).	Achsmaß mm	FB Tiefe mm	Bestell-Nr.	Laminate
	1000	250	BN07012113ZZZZZZ2	-
	1000	300	BN07013113ZZZZZZ2	-
	1000	400	BN07014113ZZZZZZ2	-

FACHBÖDEN

W4 - HOLZFACHBODEN

W4 - Holzfachboden mit Snapfix, ohne Nut für Beschriftungsschild

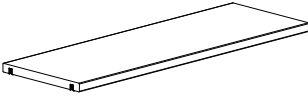
Spanplatte. Mit Beschlägen (Snapfix).	Achsmaß mm	FB Tiefe mm	Bestell-Nr.	Melamin
	500	250	BN07052006ZZZZZZ3	-
	500	300	BN07053006ZZZZZZ3	-
	500	400	BN07054006ZZZZZZ3	-
	750	250	BN07072006ZZZZZZ3	-
	750	300	BN07073006ZZZZZZ3	-
	750	400	BN07074006ZZZZZZ3	-
	900	250	BN07092006ZZZZZZ3	-
	900	300	BN07093006ZZZZZZ3	-
	900	400	BN07094006ZZZZZZ3	-

W4 - Holzfachboden mit Snapfix, ohne Nut für Beschriftungsschild

Tischlerplatte. Mit Beschlägen (Snapfix).	Achsmaß mm	FB Tiefe mm	Bestell-Nr.	Laminat
	1000	250	BN07012003ZZZZZZ3	-
	1000	300	BN07013003ZZZZZZ3	-
	1000	400	BN07014003ZZZZZZ3	-

W4 - Holzfachboden mit Snapfix und Nut für Beschriftungsschild

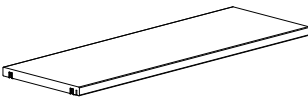
Spanplatte. Mit Beschlägen (Snapfix).	Achsmaß mm	FB Tiefe mm	Bestell-Nr.	Melamin
	500	250	BN07052016ZZZZZZ3	-
	500	300	BN07053016ZZZZZZ3	-
	500	400	BN07054016ZZZZZZ3	-
	750	250	BN07072016ZZZZZZ3	-
	750	300	BN07073016ZZZZZZ3	-
	750	400	BN07074016ZZZZZZ3	-
	900	250	BN07092016ZZZZZZ3	-
	900	300	BN07093016ZZZZZZ3	-
	900	400	BN07094016ZZZZZZ3	-

W4 - Holzfachboden mit Snapfix und Nut für Beschriftungsschild

Tischlerplatte. Mit Beschlägen (Snapfix).	Achsmaß mm	FB Tiefe mm	Bestell-Nr.	Laminat
	1000	250	BN07012013ZZZZZZ3	-
	1000	300	BN07013013ZZZZZZ3	-
	1000	400	BN07014013ZZZZZZ3	-

W4 - Holzfachboden mit Snapfix und Schrauben, ohne Nut für Beschriftungsschild

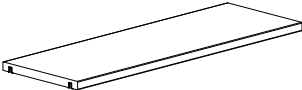
Spanplatte. Mit Beschlägen (Snapfix und Schrauben).	Achsmaß mm	FB Tiefe mm	Bestell-Nr.	Melamin
	500	250	BN07052006ZZZZZZ2	-
	500	300	BN07053006ZZZZZZ2	-
	500	400	BN07054006ZZZZZZ2	-
	750	250	BN07072006ZZZZZZ2	-
	750	300	BN07073006ZZZZZZ2	-
	750	400	BN07074006ZZZZZZ2	-
	900	250	BN07092006ZZZZZZ2	-
	900	300	BN07093006ZZZZZZ2	-
	900	400	BN07094006ZZZZZZ2	-

W4 - Holzfachboden mit Snapfix und Schrauben, ohne Nut für Beschriftungsschild

Tischlerplatte. Mit Beschlägen (Snapfix und Schrauben).	Achsmaß mm	FB Tiefe mm	Bestell-Nr.	Laminat
	1000	250	BN07012003ZZZZZZ2	-
	1000	300	BN07013003ZZZZZZ2	-
	1000	400	BN07014003ZZZZZZ2	-

W4 - Holzfachboden mit Snapfix, Schrauben und Nut für Beschriftungsschild

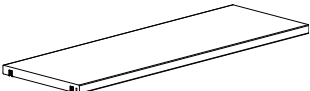
Spanplatte. Mit Beschlägen (Snapfix und Schrauben).	Achsmaß mm	FB Tiefe mm	Bestell-Nr.	Melamin
	500	250	BN07052016ZZZZZZ2	-
	500	300	BN07053016ZZZZZZ2	-
	500	400	BN07054016ZZZZZZ2	-
	750	250	BN07072016ZZZZZZ2	-
	750	300	BN07073016ZZZZZZ2	-
	750	400	BN07074016ZZZZZZ2	-
	900	250	BN07092016ZZZZZZ2	-
	900	300	BN07093016ZZZZZZ2	-
	900	400	BN07094016ZZZZZZ2	-

W4 - Holzfachboden mit Snapfix, Schrauben und Nut für Beschriftungsschild

Tischlerplatte. Mit Beschlägen (Snapfix und Schrauben).	Achsmaß mm	FB Tiefe mm	Bestell-Nr.	Laminat
	1000	250	BN07012013ZZZZZZ2	-
	1000	300	BN07013013ZZZZZZ2	-
	1000	400	BN07014013ZZZZZZ2	-

FACHBÖDEN

WT1 - HOLZABDECKBODEN

Wählen Sie einen Abdeckboden aus Metall oder Holz (zur Montage zwischen den Holzseiten) oder eine überliegende Holzabdeckplatte (zur Montage über den Holzseiten).

WT1 - HOLZABDECKBODEN

Details:

- Achsmaß 500/750/900/1000 mm
- Tiefe 250/300/400 mm
- Lackiert/furniert
- Einseitig Standardtiefe/einseitig Volltiefe / doppelseitig
- Snapfix und Schrauben
- Max. Belastung 100 kg. (Norm EN14073-3)
- Spanplatte

Benutzen mit:

- S1/S2/S3/S4 - Metallfachböden
- W1/W2/W3/W4 - Holzfachböden
- WP1/2/5/6 - Holzseiten für Abdeckboden
- WBP1/WBP3 - Holzrückwand für WT1 Standardtiefe
- WBP2/WBP4 - Holzrückwand für WT1 Volltiefe
- WBP2/WBP4 - Holzrückwand für WT1 Doppelseitig

Beachten:

- Abdeckböden aus Holz müssen immer mit Snapfix und Schrauben montiert werden.

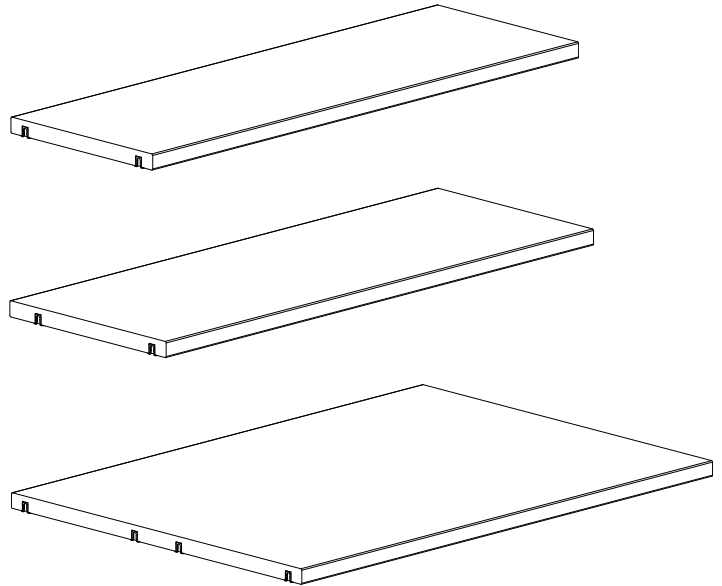

Wählen Sie einen Abdeckboden aus Metall oder Holz (zur Montage zwischen den Holzseiten) oder eine überliegende Holzabdeckplatte (zur Montage über den Holzseiten).

WT3 - HOLZABDECKBODEN

Details:

- Achsmaß 500/750/900/1000 mm
- Tiefe 250/300/400 mm
- Melamin
- Einseitig Standardtiefe/einseitig Volltiefe / doppeltseitig
- Snapfix und Schrauben
- Max. Belastung 100 kg. (Norm EN14073-3)
- Spanplatte

Benutzen mit:

- S1/S2/S3/S4 - Metallfachböden
- W1/W2/W3/W4 - Holzfachböden
- WP1/2/5/6 - Holzseiten für Abdeckboden
- WBP1/WBP3 - Holzrückwand für WT1 Standardtiefe
- WBP2/WBP4 - Holzrückwand für WT1 Volltiefe
- WBP2/WBP4 - Holzrückwand für WT1 Doppeltseitig

Beachten:

- Abdeckböden aus Holz müssen immer mit Snapfix und Schrauben montiert werden.

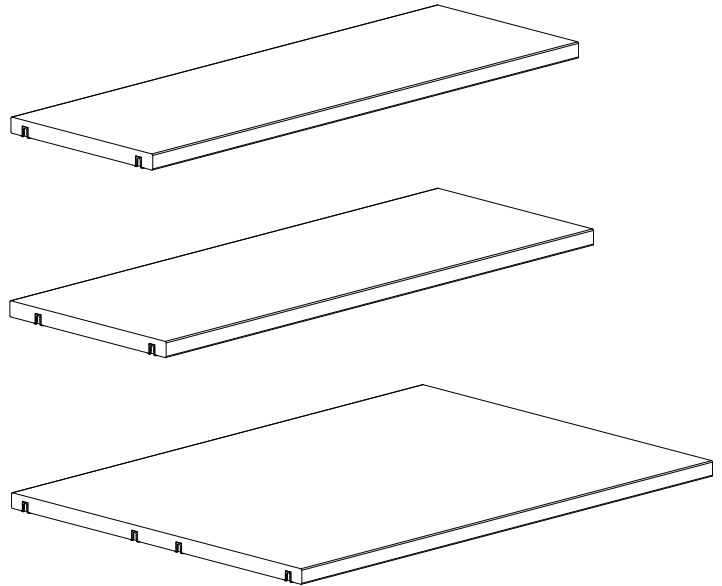

FACHBÖDEN

WT1 - HOLZABDECKBODEN - LACKIERT/FURNIERT

Lackierte und furnierte Lingo Holzfachböden haben das FSC Zertifikat.

WT1 - einseitiger Holzabdeckboden - Standardtiefe

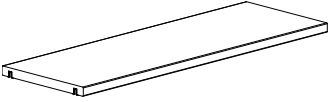
Spanplatte. Mit Beschlägen (Snapfix und Schrauben).	Achismaß mm	FB Tiefe mm	Bestell-Nr.	Lackiert	Furniert
	500	250	BN0765218.	-	-
	500	300	BN0765318.	-	-
	500	400	BN0765418.	-	-
	750	250	BN0767218.	-	-
	750	300	BN0767318.	-	-
	750	400	BN0767418.	-	-
	900	250	BN0769218.	-	-
	900	300	BN0769318.	-	-
	900	400	BN0769418.	-	-
	1000	250	BN0761218.	-	-
	1000	300	BN0761318.	-	-
	1000	400	BN0761418.	-	-

WT1 - einseitiger Holzabdeckboden - Volltiefe

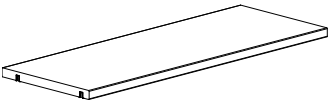
Spanplatte. Mit Beschlägen (Snapfix und Schrauben).	Achismaß mm	FB Tiefe mm	Bestell-Nr.	Lackiert	Furniert
	500	250 = 280	BN0765219.	-	-
	500	300 = 330	BN0765319.	-	-
	500	400 = 430	BN0765419.	-	-
	750	250 = 280	BN0767219.	-	-
	750	300 = 330	BN0767319.	-	-
	750	400 = 430	BN0767419.	-	-
	900	250 = 280	BN0769219.	-	-
	900	300 = 330	BN0769319.	-	-
	900	400 = 430	BN0769419.	-	-
	1000	250 = 280	BN0761219.	-	-
	1000	300 = 330	BN0761319.	-	-
	1000	400 = 430	BN0761419.	-	-

WT1 - doppelseitiger Holzabdeckboden

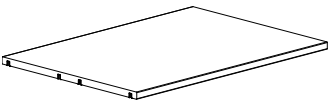
Spanplatte. Mit Beschlägen (Snapfix und Schrauben).	Achismaß mm	FB Tiefe mm	Bestell-Nr.	Lackiert	Furniert
	500	2 x 250 = 537	BN0765228.	-	-
	500	2 x 300 = 637	BN0765328.	-	-
	500	2 x 400 = 837	BN0765428.	-	-
	750	2 x 250 = 537	BN0767228.	-	-
	750	2 x 300 = 637	BN0767328.	-	-
	750	2 x 400 = 837	BN0767428.	-	-
	900	2 x 250 = 537	BN0769228.	-	-
	900	2 x 300 = 637	BN0769328.	-	-
	900	2 x 400 = 837	BN0769428.	-	-
	1000	2 x 250 = 537	BN0761228.	-	-
	1000	2 x 300 = 637	BN0761328.	-	-
	1000	2 x 400 = 837	BN0761428.	-	-

WT3 - Einseitiger Holzabdeckboden - Standardtiefe

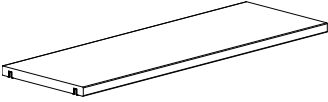
Spanplatte. Mit Beschlägen (Snapfix und Schrauben).	Achsmaß mm	FB Tiefe mm	Bestell-Nr.	Melamin
	500	250	BN07752186	-
	500	300	BN07753186	-
	500	400	BN07754186	-
	750	250	BN07772186	-
	750	300	BN07773186	-
	750	400	BN07774186	-
	900	250	BN07792186	-
	900	300	BN07793186	-
	900	400	BN07794186	-
	1000	250	BN07712186	-
	1000	300	BN07713186	-
	1000	400	BN07714186	-

WT3 - Einseitiger Holzabdeckboden - Volltiefe

Spanplatte. Mit Beschlägen (Snapfix und Schrauben).	Achsmaß mm	FB Tiefe mm	Bestell-Nr.	Melamin
	500	250 = 280	BN07752196	-
	500	300 = 330	BN07753196	-
	500	400 = 430	BN07754196	-
	750	250 = 280	BN07772196	-
	750	300 = 330	BN07773196	-
	750	400 = 430	BN07774196	-
	900	250 = 280	BN07792196	-
	900	300 = 330	BN07793196	-
	900	400 = 430	BN07794196	-
	1000	250 = 280	BN07712196	-
	1000	300 = 330	BN07713196	-
	1000	400 = 430	BN07714196	-

WT3 - Doppelseitiger Holzabdeckboden

Spanplatte. Mit Beschlägen (Snapfix und Schrauben).	Achsmaß mm	FB Tiefe mm	Bestell-Nr.	Melamin
	500	2 x 250 = 537	BN07752286	-
	500	2 x 300 = 637	BN07753286	-
	500	2 x 400 = 837	BN07754286	-
	750	2 x 250 = 537	BN07772286	-
	750	2 x 300 = 637	BN07773286	-
	750	2 x 400 = 837	BN07774286	-
	900	2 x 250 = 537	BN07792286	-
	900	2 x 300 = 637	BN07793286	-
	900	2 x 400 = 837	BN07794286	-
	1000	2 x 250 = 537	BN07712286	-
	1000	2 x 300 = 637	BN07713286	-
	1000	2 x 400 = 837	BN07714286	-

FACHBÖDEN

WO1 - HOLZABDECKPLATTE

Wählen Sie einen Abdeckboden aus Metall oder Holz (zur Montage zwischen den Holzseiten) oder eine überliegende Holzabdeckplatte (zur Montage über den Holzseiten).

WO1 - HOLZABDECKPLATTE

Details:

- Achsmaß 500/750/900/1000 mm
- Tiefe 250/300/400 mm
- Melamin/lackiert/furniert
- Ein-/doppelseitig
- Freistehend/außer/mittel
- Max. Belastung 25 kg.
- Spanplatte

Benutzen mit:

- S1/S2/S3/S4 - Metallfachböden
- W1/W2/W3/W4 - Holzfachböden
- WP3/4/7/8 - Holzseiten für Abdeckplatte
- WBP1/3 - Holzrückwand für Abdeckplatte

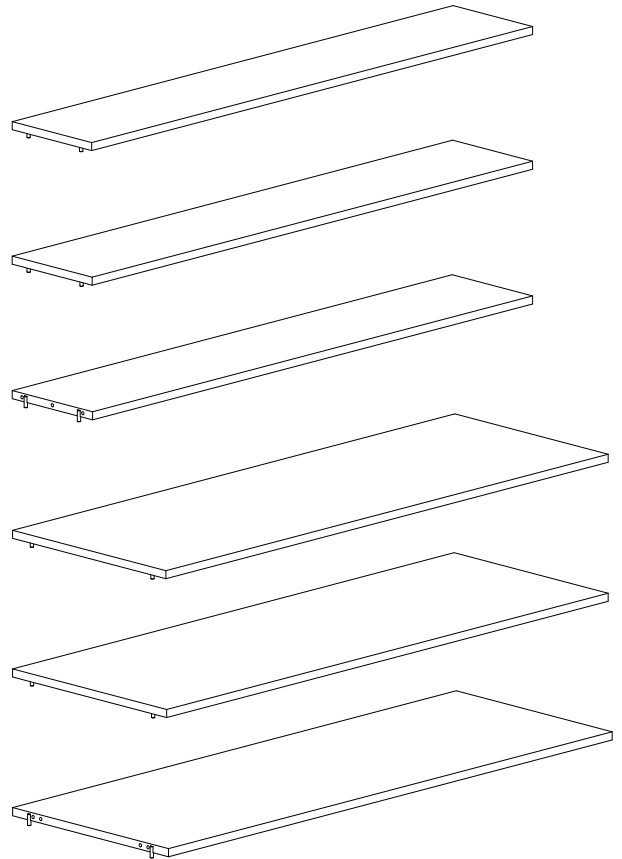

FACHBÖDEN

WO1 - HOLZABDECKBODEN - EINSEITIGER

Lackierte und furnierte Lingo Holzfachböden haben das FSC Zertifikat.

WO1 - Einseitige Holzabdeckplatte - freistehende

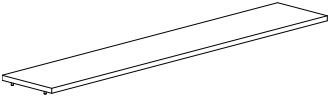
Spanplatte. Mit Beschlägen.	Achsmaß mm	FB Tiefe mm	Sek- tionen	Bestell-Nr.	Melamin	Lackiert	Furniert
	500	250	1	BN0303515.	-	-	-
	500	250	2	BN0303525.	-	-	-
	500	250	3	BN0303535.	-	-	-
	500	300	1	BN0305515.	-	-	-
	500	300	2	BN0305525.	-	-	-
	500	300	3	BN0305535.	-	-	-
	500	400	1	BN0307515.	-	-	-
	500	400	2	BN0307525.	-	-	-
	500	400	3	BN0307535.	-	-	-
	750	250	1	BN0303715.	-	-	-
	750	250	2	BN0303725.	-	-	-
	750	250	3	BN0303735.	-	-	-
	750	300	1	BN0305715.	-	-	-
	750	300	2	BN0305725.	-	-	-
	750	300	3	BN0305735.	-	-	-
	750	400	1	BN0307715.	-	-	-
	750	400	2	BN0307725.	-	-	-
	750	400	3	BN0307735.	-	-	-
	900	250	1	BN0303915.	-	-	-
	900	250	2	BN0303925.	-	-	-
	900	300	1	BN0305915.	-	-	-
	900	300	2	BN0305925.	-	-	-
	900	400	1	BN0307915.	-	-	-
	900	400	2	BN0307925.	-	-	-
1000	250	1	BN0303115.	-	-	-	
1000	250	2	BN0303125.	-	-	-	
1000	300	1	BN0305115.	-	-	-	
1000	300	2	BN0305125.	-	-	-	
1000	400	1	BN0307115.	-	-	-	
1000	400	2	BN0307125.	-	-	-	

Lackierte und furnierte Lingo Holzfachböden haben das FSC Zertifikat.

WO1 - Einseitige Holzabdeckplatte - äußere

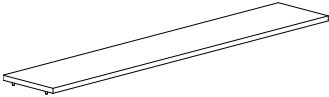
Spanplatte. Mit Beschlägen.	Achsmaß mm	FB Tiefe mm	Sek- tionen	Bestell-Nr.	Melamin	Lackiert	Furniert
	500	250	1	BN0303514.	-	-	-
	500	250	2	BN0303524.	-	-	-
	500	250	3	BN0303534.	-	-	-
	500	300	1	BN0305514.	-	-	-
	500	300	2	BN0305524.	-	-	-
	500	300	3	BN0305534.	-	-	-
	500	400	1	BN0307514.	-	-	-
	500	400	2	BN0307524.	-	-	-
	500	400	3	BN0307534.	-	-	-
	750	250	1	BN0303714.	-	-	-
	750	250	2	BN0303724.	-	-	-
	750	250	3	BN0303734.	-	-	-
	750	300	1	BN0305714.	-	-	-
	750	300	2	BN0305724.	-	-	-
	750	300	3	BN0305734.	-	-	-
	750	400	1	BN0307714.	-	-	-
	750	400	2	BN0307724.	-	-	-
	750	400	3	BN0307734.	-	-	-
	900	250	1	BN0303914.	-	-	-
	900	250	2	BN0303924.	-	-	-
	900	300	1	BN0305914.	-	-	-
	900	300	2	BN0305924.	-	-	-
	900	400	1	BN0307914.	-	-	-
	900	400	2	BN0307924.	-	-	-
1000	250	1	BN0303114.	-	-	-	
1000	250	2	BN0303124.	-	-	-	
1000	300	1	BN0305114.	-	-	-	
1000	300	2	BN0305124.	-	-	-	
1000	400	1	BN0307114.	-	-	-	
1000	400	2	BN0307124.	-	-	-	

FACHBÖDEN

WO1 - HOLZABDECKBODEN - EINSEITIGER

Lackierte und furnierte Lingo Holzfachböden haben das FSC Zertifikat.

WO1 - Einseitige Holzabdeckplatte - mittlere

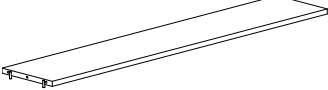
Spanplatte. Mit Beschlägen.	Achsmaß mm	FB Tiefe mm	Sek- tionen	Bestell-Nr.	Melamin	Lackiert	Furniert
	500	250	1	BN0303513.	-	-	-
	500	250	2	BN0303523.	-	-	-
	500	250	3	BN0303533.	-	-	-
	500	300	1	BN0305513.	-	-	-
	500	300	2	BN0305523.	-	-	-
	500	300	3	BN0305533.	-	-	-
	500	400	1	BN0307513.	-	-	-
	500	400	2	BN0307523.	-	-	-
	500	400	3	BN0307533.	-	-	-
	750	250	1	BN0303713.	-	-	-
	750	250	2	BN0303723.	-	-	-
	750	250	3	BN0303733.	-	-	-
	750	300	1	BN0305713.	-	-	-
	750	300	2	BN0305723.	-	-	-
	750	300	3	BN0305733.	-	-	-
	750	400	1	BN0307713.	-	-	-
	750	400	2	BN0307723.	-	-	-
	750	400	3	BN0307733.	-	-	-
	900	250	1	BN0303913.	-	-	-
	900	250	2	BN0303923.	-	-	-
	900	300	1	BN0305913.	-	-	-
900	300	2	BN0305923.	-	-	-	
900	400	1	BN0307913.	-	-	-	
900	400	2	BN0307923.	-	-	-	
1000	250	1	BN0303113.	-	-	-	
1000	250	2	BN0303123.	-	-	-	
1000	300	1	BN0305113.	-	-	-	
1000	300	2	BN0305123.	-	-	-	
1000	400	1	BN0307113.	-	-	-	
1000	400	2	BN0307123.	-	-	-	

Lackierte und furnierte Lingo Holzfachböden haben das FSC Zertifikat.

WO1 - Doppelseitige Holzabdeckplatte - freistehende

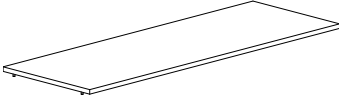
Spanplatte. Mit Beschlägen.	Achsmaß mm	FB Tiefe mm	Sek- tionen	Bestell-Nr.	Melamin	Lackiert	Furniert
	500	250	1	BN0304515.	-	-	-
	500	250	2	BN0304525.	-	-	-
	500	250	3	BN0304535.	-	-	-
	500	300	1	BN0306515.	-	-	-
	500	300	2	BN0306525.	-	-	-
	500	300	3	BN0306535.	-	-	-
	500	400	1	BN0308515.	-	-	-
	500	400	2	BN0308525.	-	-	-
	500	400	3	BN0308535.	-	-	-
	750	250	1	BN0304715.	-	-	-
	750	250	2	BN0304725.	-	-	-
	750	250	3	BN0304735.	-	-	-
	750	300	1	BN0306715.	-	-	-
	750	300	2	BN0306725.	-	-	-
	750	300	3	BN0306735.	-	-	-
	750	400	1	BN0308715.	-	-	-
	750	400	2	BN0308725.	-	-	-
	750	400	3	BN0308735.	-	-	-
	900	250	1	BN0304915.	-	-	-
	900	250	2	BN0304925.	-	-	-
	900	300	1	BN0306915.	-	-	-
	900	300	2	BN0306925.	-	-	-
	900	400	1	BN0308915.	-	-	-
	900	400	2	BN0308925.	-	-	-
1000	250	1	BN0304115.	-	-	-	
1000	250	2	BN0304125.	-	-	-	
1000	300	1	BN0306115.	-	-	-	
1000	300	2	BN0306125.	-	-	-	
1000	400	1	BN0308115.	-	-	-	
1000	400	2	BN0308125.	-	-	-	

FACHBÖDEN

WO1 - HOLZABDECKBODEN - DOPPELSEITIGER

Lackierte und furnierte Lingo Holzfachböden haben das FSC Zertifikat.

WO1 - Doppelseitige Holzabdeckplatte - äußere

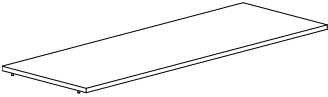
Spanplatte. Mit Beschlägen.	Achsmaß mm	FB Tiefe mm	Sek- tionen	Bestell-Nr.	Melamin	Lackiert	Furniert
	500	250	1	BN0304514.	-	-	-
	500	250	2	BN0304524.	-	-	-
	500	250	3	BN0304534.	-	-	-
	500	300	1	BN0306514.	-	-	-
	500	300	2	BN0306524.	-	-	-
	500	300	3	BN0306534.	-	-	-
	500	400	1	BN0308514.	-	-	-
	500	400	2	BN0308524.	-	-	-
	500	400	3	BN0308534.	-	-	-
	750	250	1	BN0304714.	-	-	-
	750	250	2	BN0304724.	-	-	-
	750	250	3	BN0304734.	-	-	-
	750	300	1	BN0306714.	-	-	-
	750	300	2	BN0306724.	-	-	-
	750	300	3	BN0306734.	-	-	-
	750	400	1	BN0308714.	-	-	-
	750	400	2	BN0308724.	-	-	-
	750	400	3	BN0308734.	-	-	-
	900	250	1	BN0304914.	-	-	-
	900	250	2	BN0304924.	-	-	-
	900	300	1	BN0306914.	-	-	-
	900	300	2	BN0306924.	-	-	-
	900	400	1	BN0308914.	-	-	-
	900	400	2	BN0308924.	-	-	-
1000	250	1	BN0304114.	-	-	-	
1000	250	2	BN0304124.	-	-	-	
1000	300	1	BN0306114.	-	-	-	
1000	300	2	BN0306124.	-	-	-	
1000	400	1	BN0308114.	-	-	-	
1000	400	2	BN0308124.	-	-	-	

Lackierte und furnierte Lingo Holzfachböden haben das FSC Zertifikat.

WO1 - Doppelseitige Holzabdeckplatte - mittlere

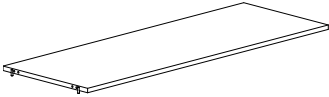
Spanplatte. Mit Beschlägen.	Achsmaß mm	FB Tiefe mm	Sek- tionen	Bestell-Nr.	Melamin	Lackiert	Furniert
	500	250	1	BN0304513.	-	-	-
	500	250	2	BN0304523.	-	-	-
	500	250	3	BN0304533.	-	-	-
	500	300	1	BN0306513.	-	-	-
	500	300	2	BN0306523.	-	-	-
	500	300	3	BN0306533.	-	-	-
	500	400	1	BN0308513.	-	-	-
	500	400	2	BN0308523.	-	-	-
	500	400	3	BN0308533.	-	-	-
	750	250	1	BN0304713.	-	-	-
	750	250	2	BN0304723.	-	-	-
	750	250	3	BN0304733.	-	-	-
	750	300	1	BN0306713.	-	-	-
	750	300	2	BN0306723.	-	-	-
	750	300	3	BN0306733.	-	-	-
	750	400	1	BN0308713.	-	-	-
	750	400	2	BN0308723.	-	-	-
	750	400	3	BN0308733.	-	-	-
	900	250	1	BN0304913.	-	-	-
	900	250	2	BN0304923.	-	-	-
	900	300	1	BN0306913.	-	-	-
	900	300	2	BN0306923.	-	-	-
	900	400	1	BN0308913.	-	-	-
	900	400	2	BN0308923.	-	-	-
1000	250	1	BN0304113.	-	-	-	
1000	250	2	BN0304123.	-	-	-	
1000	300	1	BN0306113.	-	-	-	
1000	300	2	BN0306123.	-	-	-	
1000	400	1	BN0308113.	-	-	-	
1000	400	2	BN0308123.	-	-	-	

FACHBÖDEN

PRÄSENTATIONS- & AUFBEWAHRUNG

Metallfachboden für Taschenbücher

Mit Befestigungsmaterial.
H200 x T225 mm.

Achsmaß
mm

Bestell-Nr.

900

BN520

-



Metallfachboden für CDs

Mit Befestigungsmaterial.
H175 x T200 mm

Achsmaß
mm

Bestell-Nr.

750

B7851737

-

900

B7851739

-

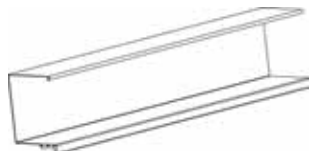

Metallfachboden für DVDs

Mit Befestigungsmaterial.
H273 x T300 mm.

Achsmaß
mm

Bestell-Nr.

750

B7851707

-

900

B7851709

-



FACHBÖDEN

PRÄSENTATIONS- & AUFBEWAHRUNG

Metallfachboden - 4 Fächer (B22.4 cm) mit 3 Metallfachteilern

Mit Beschläge. B900 x H200 x Txx mm.
Kapazität: 75 Bilderbücher.

Tiefe
mm

Bestell-Nr.

250
300

BN5162
BN5163

-
-

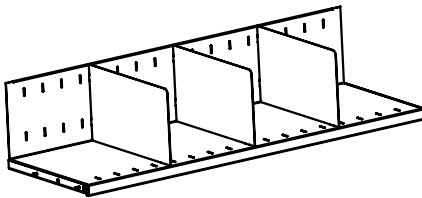

Metallwinkelfachboden

Mit Beschläge.

Achsmaß
mm

Regaltiefe
mm

Bestell-Nr.

500
500
750
750
900
900
1000
1000

250
300
250
300
250
300
250
300

BN53052
BN53053
BN53072
BN53073
BN53092
BN53093
BN53012
BN53013

-
-
-
-
-
-
-
-

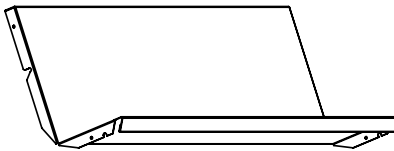

ZUBEHÖR

TRÖGE

Metalltrög - eine Ebene - ohne/mit Auszug

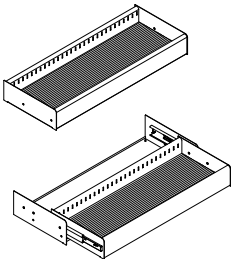
B750 mm. Mit Beschlägen und Gummimatte. Ohne Stäbe.	Holzseite Tiefe mm	Höhe mm	Tiefe mm	Anzahl Fachteiler	Bestell-Nr. Ohne Auszug	Bestell-Nr. Mit Auszug		
	300	100	300 ^{*1}	0	BN55073100	-	BN55273500	-
	300	100	300	1	BN55073101	-	BN55273501	-
	300	100	300	2	BN55073102	-	BN55273502	-
	300	100	300	4	BN55073104	-	BN55273504	-

Metalltrög - eine Ebene - ohne/mit Auszug

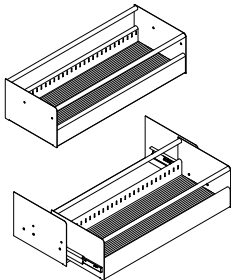
B750 mm. Mit Beschlägen, Gummimatte und Stäbe.	Holzseite Tiefe mm	Höhe mm	Tiefe mm	Anzahl Fachteiler	Bestell-Nr. Ohne Auszug	Bestell-Nr. Mit Auszug		
	300	200	300 ^{*2}	0	BN55073200	-	BN55273600	-
	300	200	300	1	BN55073201	-	BN55273601	-
	300	200	300	2	BN55073202	-	BN55273602	-
	300	200	300	4	BN55073204	-	BN55273604	-

Metalltrög - eine Ebene - ohne/mit Auszug

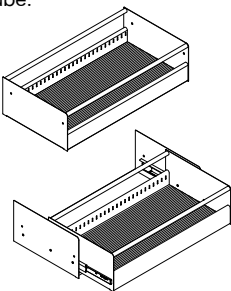
B750 mm. Mit Beschlägen, Gummimatte und Stäbe.	Holzseite Tiefe mm	Höhe mm	Tiefe mm	Anzahl Fachteiler	Bestell-Nr. Ohne Auszug	Bestell-Nr. Mit Auszug		
	300	200	400 ^{*3}	0	BN55073300	-		-
	300	200	400	1	BN55073301	-		-
	300	200	400	2	BN55073302	-		-
	300	200	400	4	BN55073304	-		-
	400	200	400	0	BN55074300	-	BN55274700	-
	400	200	400	1	BN55074301	-	BN55274701	-
	400	200	400	2	BN55074302	-	BN55274702	-
	400	200	400	4	BN55074304	-	BN55274704	-

Metalltrög - zwei Ebenen - ohne/mit Auszug

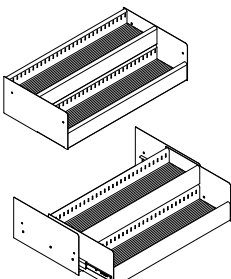
B750 mm. Mit Beschlägen und Gummimatte. Ohne Stäbe.	Holzseite Tiefe mm	Höhe mm	Tiefe mm	Anzahl Fachteiler	Bestell-Nr. Ohne Auszug	Bestell-Nr. Mit Auszug		
	300	200	400 ^{*4}	0	BN55073400	-		-
	300	200	400	2	BN55073402	-		-
	300	200	400	4	BN55073404	-		-
	300	200	400	8	BN55073408	-		-
	400	200	400	0	BN55074400	-	BN55274800	-
	400	200	400	2	BN55074402	-	BN55274802	-
	400	200	400	4	BN55074404	-	BN55274804	-
	400	200	400	8	BN55074408	-	BN55274808	-

Metalltrög - eine Ebene - ohne/mit Auszug

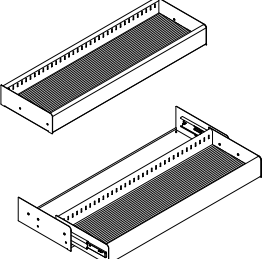
B900 mm. Mit Beschlägen und Gummimatte. Ohne Stäbe.	Holzseite Tiefe mm	Höhe mm	Tiefe mm	Anzahl Fachteiler	Bestell-Nr. Ohne Auszug	Bestell-Nr. Mit Auszug		
	300	100	300 ^{*1}	0	BN55093100	-	BN55293500	-
	300	100	300	2	BN55093102	-	BN55293502	-
	300	100	300	4	BN55093104	-	BN55293504	-
	300	1000	300	5	BN55093105	-	BN55293505	-

Metalltrög - eine Ebene - ohne/mit Auszug

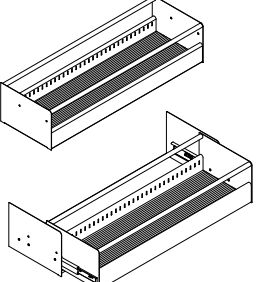
B900 mm. Mit Beschlägen, Gummimatte und Stäbe.	Holzseite Tiefe mm	Höhe mm	Tiefe mm	Anzahl Fachteiler	Bestell-Nr. Ohne Auszug	Bestell-Nr. Mit Auszug		
	300	200	300 ^{*2}	0	BN55093200	-	BN55293600	-
	300	200	300	2	BN55093202	-	BN55293602	-
	300	200	300	4	BN55093204	-	BN55293604	-
	300	200	300	5	BN55093205	-	BN55293605	-

Metalltrög - eine Ebene - ohne/mit Auszug

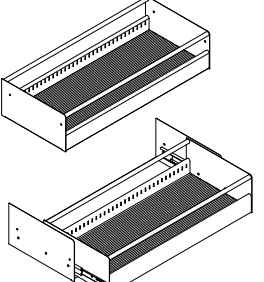
B900 mm. Mit Beschlägen, Gummimatte und Stäbe.	Holzseite Tiefe mm	Höhe mm	Tiefe mm	Anzahl Fachteiler	Bestell-Nr. Ohne Auszug	Bestell-Nr. Mit Auszug			
	300	200	400 ^{*3}	0	BN55093300	-			
	300	200	400	2	BN55093302	-			
	300	200	400	4	BN55093304	-			
	300	200	400	5	BN55093305	-			
	400	200	400	0	BN55094300	-	BN55294700	-	
	400	200	400	2	BN55094302	-	BN55294702	-	
	400	200	400	4	BN55094304	-	BN55294704	-	
	400	200	400	5	BN55094305	-	BN55294705	-	

Metalltrög - zwei Ebenen - ohne/mit Auszug

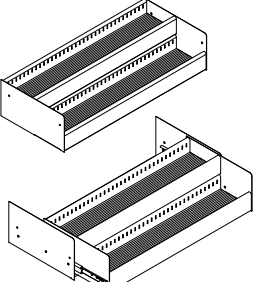
B900 mm. Mit Beschlägen und Gummimatte. Ohne Stäbe.	Holzseite Tiefe mm	Höhe mm	Tiefe mm	Anzahl Fachteiler	Bestell-Nr. Ohne Auszug	Bestell-Nr. Mit Auszug			
	300	200	400 ^{*4}	0	BN55093400	-			
	300	200	400	4	BN55093404	-			
	300	200	400	8	BN55093408	-			
	300	200	400	10	BN55093410	-			
	400	200	400	0	BN55094400	-	BN55294800	-	
	400	200	400	4	BN55094404	-	BN55294804	-	
	400	200	400	8	BN55094408	-	BN55294808	-	
	400	200	400	10	BN55094410	-	BN55294810	-	

ZUBEHÖR

TRÖGE

AV Medienmetalltrog - als Fachbodenaufsatz

H100 mm. Trog und Fachteiler Metall lackiert. Mit schwarz beflockten Metallstäben, Antirutschleinlage und mit 2 bis 5 versetzbare Fachteiler. Arretierung auf Metall-/Holzfachböden T 250 oder 300 mm ohne Buchenschlag.

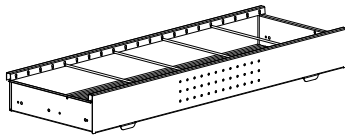

Achsmaß mm	FB Tiefe mm	Anzahl Fachteiler	Bestell-Nr.	
500	250	2	B405085552102	-
500	300	2	B405085553102	-
500	400	2	B405085554102	-
750	250	3	B405085572103	-
750	300	3	B405085573102	-
750	400	3	B405085574103	-
900	250	4	B405085592104	-
900	300	4	B405085593104	-
900	400	4	B405085594104	-
1000	250	5	B405085512105	-
1000	300	5	B405085513105	-
1000	400	5	B405085514105	-

AV Medienmetalltrog - zum Einhängen

H100 mm. Trog und Fachteiler Metall lackiert. Mit schwarz beflockten Metallstäben, Antirutschleinlage und mit 2 bis 5 versetzbare Fachteiler. Zum Einhängen in die Tragrahmen. Mit Kippsicherung.

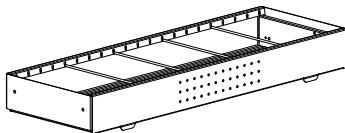

Achsmaß mm	FB Tiefe mm	Anzahl Fachteiler	Bestell-Nr.	
500	250	2	B405085552302	-
500	300	2	B405085553302	-
500	400	2	B405085554302	-
750	250	3	B405085572303	-
750	300	3	B405085573303	-
750	400	3	B405085574303	-
900	250	4	B405085592304	-
900	300	4	B405085593304	-
900	400	4	B405085594304	-
1000	250	5	B405085512305	-
1000	300	5	B405085513305	-
1000	400	5	B405085514305	-

Aus Sicherheitsgründen dürfen ausziehbare Multimediawannen mit maximal 15 kg beladen werden, Wandregale mit maximal 3 Auszügen und Doppelregale mit maximal 1 Auszug pro Seite bestückt werden. Fahrbare Regale dürfen nicht mit Auszügen ausgestattet werden. Die unterste Schublade muss mindestens 50 cm über dem Boden eingesetzt werden, um einen Missbrauch als Stufe zu verhindern.

AV Medienmetalltrog - zum Einhängen - ausziehbar

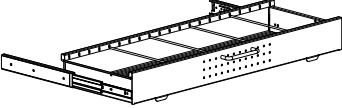
H100 mm. Trog und Fachteiler Metall lackiert. Mit schwarz beflockten Metall-stäben, Antirutsch-einlage, Kippsicherungen und mit 2 bis 5 versetzbare Fachteiler. Mit Griff und Teleskopvollauszug. Zum Einhängen in die Tragrahmen. Mit Kippsicherung.	Achsmaß mm	FB Tiefe mm	Anzahl Fachteiler	Bestell-Nr.	
	500	250	2	B405085552502	-
	500	300	2	B405085553502	-
	500	400	2	B405085554502	-
	750	250	3	B405085572503	-
	750	300	3	B405085573503	-
	750	400	3	B405085574503	-
	900	250	4	B405085592504	-
	900	300	4	B405085593504	-
	900	400	4	B405085594504	-
	1000	250	5	B405085512505	-
	1000	300	5	B405085513505	-
	1000	400	5	B405085514505	-

AV Medienmetalltrog - zum Einhängen – ausziehbar mit Selbsteinzug

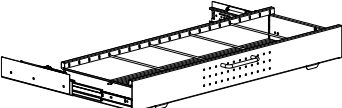
H100 mm. Trog und Fachteiler Metall lackiert. Mit schwarz beflockten Metall-stäben, Anti-rutscheinlage, Kippsicherungen und mit 2 bis 5 versetzbare Fachteiler. Mit Griff, Teleskop-vollauszug mit Selbsteinzug. Zum Einhängen in die Tragrahmen. Mit Kippsicherung.	Achsmaß mm	FB Tiefe mm	Anzahl Fachteiler	Bestell-Nr.	
	500	250	2	B405085552702	-
	500	300	2	B405085553702	-
	500	400	2	B405085554702	-
	750	250	3	B405085572703	-
	750	300	3	B405085573703	-
	750	400	3	B405085574703	-
	900	250	4	B405085592704	-
	900	300	4	B405085593704	-
	900	400	4	B405085594704	-
	1000	250	5	B405085512705	-
	1000	300	5	B405085513705	-
	1000	400	5	B405085514705	-

ZUBEHÖR

TRÖGE

Fachteiler für Metalltrog mit einer/zwei Ebene(n)

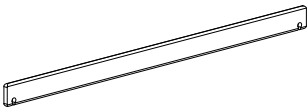
Zusätzlicher Fachteiler. Stahl verchromt.	Ebene	Höhe mm	FB Tiefe mm	Bestell-Nr.	
	Eine	100	300	B4011603	-
	Eine	200	300	B4011603	-
	Eine	200	400	B4011604	-
	Zwei	200	400	B4011601	-

Fachteiler für AV Medienmetalltrog

Zusätzlicher Fachteiler. Metallstab schwarz beflocht.	FB Tiefe mm	Bestell-Nr.	
	250	B4010702	-
	300	B4010703	-
	400	B4010704	-

Kapazität für 750 mm Metalltrog mit einer/zwei Ebene(n) ohne Auszug (siehe Seite 168)

	Type	Achsmaß	H x T mm	CD Boxen	DVD Boxen	CD/DVD Hüllen	Unterhaltungs- literatur	Bilderbücher
				5 Reihen	5 Reihen	5 Reihen	3 Reihen	2 Reihen
*1	Eine	750	100 x 300	100	75	325	-	-
*2	Eine	750	200 x 300	100	75	325	90	40
*3	Eine	750	200 x 400	150	105	325	120	50
				2 x 5 Reihen	2 x 5 Reihen	2 x 5 Reihen	3 Reihen	2 Reihen
*4	Zwei	750	200 x 400	130	95	400	-	-

Kapazität für 750 mm Metalltrog mit einer/zwei Ebene(n) mit Auszug (siehe Seite 168)

	Type	Achsmaß	H x T mm	CD Boxen	DVD Boxen	CD/DVD Hüllen	Unterhaltungs- literatur	Bilderbücher
				5 Reihen	5 Reihen	5 Reihen	3 Reihen	2 Reihen
*1	Eine	750	100 x 300	80	60	260	-	-
*2	Eine	750	200 x 300	80	60	260	90	40
*3	Eine	750	200 x 400	120	84	340	120	50
				2 x 5 Reihen	2 x 5 Reihen	2 x 5 Reihen	3 Reihen	2 Reihen
*4	Zwei	750	200 x 400	104	76	320	-	-

Kapazität für 900 mm Metalltrog mit einer/zwei Ebene(n) ohne Auszug (siehe Seite 169)

	Type	Achsmaß	H x T mm	CD Boxen	DVD Boxen	CD/DVD Hüllen	Unterhaltungs- literatur	Bilderbücher
				6 Reihen	6 Reihen	6 Reihen	4 Reihen	3 Reihen
*1	Eine	900	100 x 300	120	90	390	-	-
*2	Eine	900	200 x 300	120	90	390	120	60
*3	Eine	900	200 x 400	180	126	510	180	75
				2 x 6 Reihen	2 x 6 Reihen	2 x 6 Reihen	4 Reihen	3 Reihen
*4	Zwei	900	200 x 400	156	114	480	-	-

Kapazität für 900 mm Metalltrog mit einer/zwei Ebene(n) mit Auszug (siehe Seite 169)

	Type	Achsmaß	H x T mm	CD Boxen	DVD Boxen	CD/DVD Hüllen	Unterhaltungs- literatur	Bilderbücher
				6 Reihen	6 Reihen	6 Reihen	4 Reihen	3 Reihen
*1	Eine	900	100 x 300	100	75	325	-	-
*2	Eine	900	200 x 300	100	75	325	120	60
*3	Eine	900	200 x 400	150	105	425	160	75
				2 x 6 Reihen	2 x 6 Reihen	2 x 6 Reihen	4 Reihen	3 Reihen
*4	Zwei	900	200 x 400	130	95	400	-	-

Kapazität für 500/750/900/1000 mm AV Medienmetalltrog (siehe Seite 170-171)

Achsmaß	Tiefe mm	CD/DVD Boxen		Achsmaß	Tiefe mm	CD/DVD Boxen
500	250	60		500	300	72
750	250	80		750	300	96
900	250	100		900	300	120
1000	250	120		1000	300	144

ZUBEHÖR

TRÖGE

FSC Holztrog für Bilderbücher mit 4 verstellbaren Fächern.

B900 x H220/120 x T300 mm.
Mit 4 Fachteilern und Beschlägen.

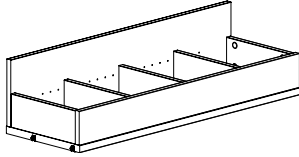

Oberfläche

Bestell-Nr.

Furniert

BN5107

-

Lackiert

BN5102

-

FSC Holztrog für CD/DVD mit 5 verstellbaren Fächern.

B900 x H170/130 x T300 mm.
Mit 4 Fachteilern und Auszug.

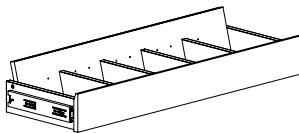

Oberfläche

Bestell-Nr.

Furniert

B7840045

-

Lackiert

B7840041

-

FSC Präsentationskassette aus Holz mit 8 Acrylfächern

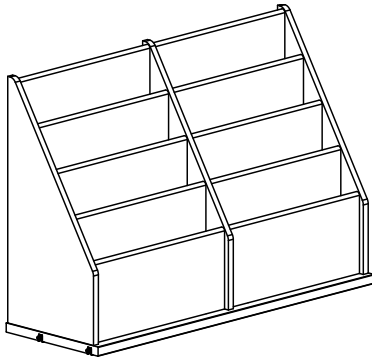

Achsmaß mm	Tiefe mm	Oberfläche	Bestell-Nr.	
900	300	Melamin	BN5286	-
900	300	Lackeirt	BN5287	-
900	300	Furniert	BN5282	-

ZUBEHÖR

PRÄSENTATIONS- & AUFBEWAHRUNG

Wenn die Metallzeitschriftenbox auf dem unteren Fachboden platziert wird empfehlen wir ein 400mm tiefen Fachboden zu verwenden.

Metallzeitschriftenbox - mit 1 Auslageklappe

H400 mm. Mit Magazinraum zur Unterbringung sowohl liegenden Zeitschriften als auch aufrechtstehender gebundener Zeitschriften (bis zu 320 mm Höhe).

Achsmaß mm	Tiefe mm
900	300
900	400

Bestell-Nr.	
BN5023	-
BN5024	-

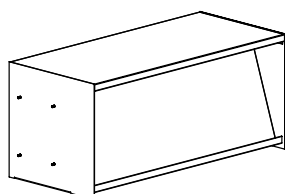

Zeitschriftenbox - mit 1 Auslageklappe und verstellbaren Fachteilern

H400 mm. Mit Magazinraum zur Unterbringung von sowohl liegenden Zeitschriften als auch aufrechten stehender gebundener Zeitschriften (bis zu 320 mm Höhe). Die Fachteiler sind verstellbare alle 50 mm.

Achsmaß mm	Tiefe mm
900	300
900	400

Bestell-Nr.	
BN5043	-
BN5044	-

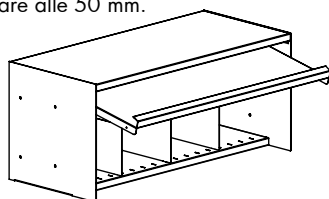

Zeitschriftenbox - mit 3 Auslageklappen

H400 mm. Mit Magazinraum zur Unterbringung von sowohl liegenden Zeitschriften als auch aufrechtstehender gebundener Zeitschriften (bis zu 320 mm Höhe).

Achsmaß mm	Tiefe mm
900	300
900	400

Bestell-Nr.	
BN5063	-
BN5064	-

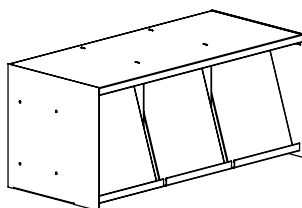

Metallzeitschriftenbox - Unibox

H320 x B320 x T260 mm. Box und Klappe Metall lackiert. Mit Folie. Es wird empfohlen, die Box auf Fachböden T250 mm aus Metall, mit oder ohne Buchanschlag oder aus Holzwerkstoff, ohne Buchanschlag einzusetzen. Auch für Fachböden T300 mm verwendbar. Stapelhöhe für horizontal gelagerte Zeitschriften 140 mm.

Design	Rückwand	Bestell-Nr.	
-	Ja	B405502001	-
-	Nein	B405502000	-
Mit Loch	Ja	B405502051	-
Mit Loch	Nein	B405502050	-
Mit Schlitz	Ja	B405502101	-
Mit Schlitz	Nein	B405502100	-

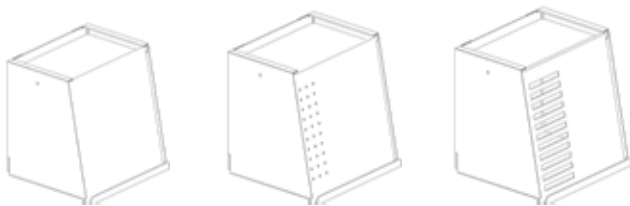

Metallzeitschriftenbox

H320 x B320 x T260 mm. Es wird empfohlen, die Box auf Fachböden T250 mm aus Metall, mit oder ohne Buchanschlag oder aus Holzwerkstoff, ohne Buchanschlag einzusetzen. Auch für Fachbodentiefe 300 mm verwendbar. Stapelhöhe für horizontal gelagerte Zeitschriften 140 mm.

Bestell-Nr.	
B405504	-

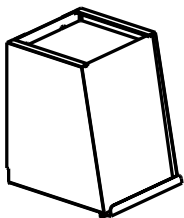

Metallzeitschriftenklappe

H 340 mm (ohne Fachboden - nicht inkludiert). Mindestabstand zwischen den Fachböden 327 mm. Mit den Stirnseite zu verschrauben. Eine wirksame Hebelmechanik hält die angehobene Klappe offen. Einfache Nachrüstung für ein- und doppelseitige Regale. Die Verwendung in Regalen mit Rückwänden wird empfohlen. Stapelhöhe für horizontal gelagerte Zeitschriften 160 mm.

Module mm	Depth mm	Bestell-Nr.	
500	250	BN50025	-
500	300	BN50035	-
500	400	BN50045	-
750	250	BN50027	-
750	300	BN50037	-
750	400	BN50047	-
900	250	BN50029	-
900	300	BN50039	-
900	400	BN50049	-
1000	250	BN50021	-
1000	300	BN50031	-
1000	400	BN50041	-

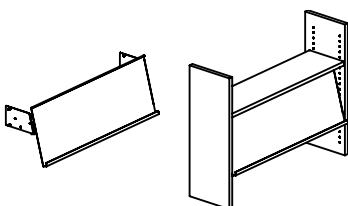

ZUBEHÖR

PRÄSENTATIONS- & AUFBEWAHRUNG - FÜR FACHBÖDEN

Metallzeitschriftenaufsteller

H300 mm. Leichte Schrägstellung. Stirnseitige Abkantung und Untergreifsicherung für optimale Führung am Fachboden aus Metall. Mit rutschhemmenden Unterlagen, um das Verrutschen auf dem Fachboden zu verhindern.

Größe	Breite mm
DIN A4	220
DIN A3	440

Bestell-Nr.

B4055064	-
B4055063	-

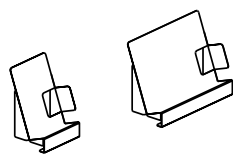

Metallzeitschriftensammler

H300 x B95 x T240 mm. Metall lackiert. Einzelelement, schräggestellt, durch Steckverbindungen beliebig nebeneinander addierbar.
Für Regal B 750 mm, 6 Stck.
Für Regal B 900 mm, 8 Stck.
Für Regal B 1000 mm, 9 Stck.

Größe

DIN A4

Bestell-Nr.

B405508

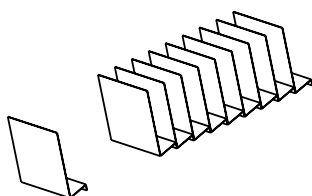

Metall U-Stütze

H250 x B145 x T220 mm.
Metall lackiert. Vielseitig einsetzbar.

Bestell-Nr.

B405510

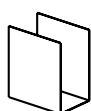

Zeitschriftensammler

H325 x B80 x T230 mm.
Kunststoff hellgrau. Vielseitige
Möglichkeit zur Magazinierung.
Mit stirnseitiger Kante zur Führung
am Fachboden.

Bestell-Nr.

B4056016

-

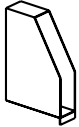

Metalthementrog

H120 x T220 x B150 mm.
Metall lackiert. Mit rutschhemmenden
Unterlagen. Antirutscheinlage ist
gesondert zu bestellen.

Bestell-Nr.

Themenwanne für 20 CDs
Antirutscheinlage

B405536

B405538

-

-

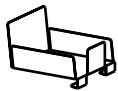

ZUBEHÖR

BUCHSTÜTZEN

Buchstütze an Metallbuchanschlag geführt - für S1

Vernickelt, Ø6 mm, mit Nylon-Gleiter.

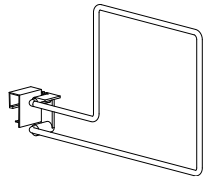

Höhe mm	FB Tiefe mm	Type	Bestell-Nr.	
163	250	Bücher auf den linken Seite	B4011221	-
163	300	Bücher auf den linken Seite	B4011222	-
243	250/300	Bücher auf den linken Seite	B4011223	-
163	250	Bücher auf den rechten Seite	B4011224	-
163	300	Bücher auf den rechten Seite	B4011225	-

Hängebuchstütze - für S2 und W2/4 mit Schiene

Erhältlich in verchromtem Metall oder in Standardmetallfarben.

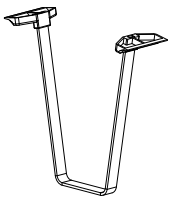

Höhe mm	Bestell-Nr.	
200	B4011242	-
250	B4011245	-

Schiene für Hängebuchstütze unter Holzfachböden W2 & W4

Zur Montage unter Holzfachböden. Für Hängebuchstütze B40112x. Mit Beschlägen.

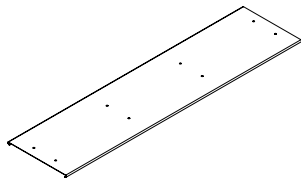

Achsmaß mm	Bestell-Nr.	
750	B4022007	-
900	B4022009	-

Hängebuchstütze - für S3, S4 & ST3

Rundstahl verchromt mit bruch-sicheren Kunststoffgleitern. Zum Einhängen in Metallfachböden. Beliebig verstellbar.

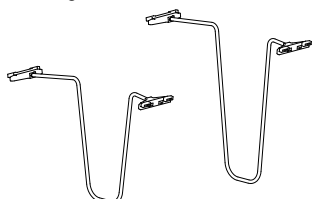

Höhe mm	FB Tiefe mm	Bestell-Nr.	
220	250	B40553032	-
220	300	B40553033	-
280	250	B40553062	-
280	300	B40553063	-

Trennschied für Hängebuchstützen

H250 x T240 mm. Kunststoff weiß. Zum Aufschieben auf Hängebuchstützen B405530. Der Trennschied liegt auf dem Fachboden auf. Ideal für Loseblattsammlungen, Broschüren, Notenhefte etc.

Bestell-Nr.

B40553152

-



Metallwinkelbuchstütze

B150 x H150 x T150 mm.

Bestell-Nr.

B401120

-

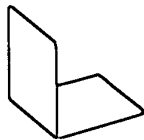

Metallwinkelbuchstütze

B120 x T150 mm.

Höhe
mm

Bestell-Nr.

175
240

B4055321

-

B4055324

-

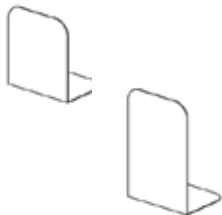

Metallwinkelbuchstütze

B150 x H200 x T150 mm. Anbringung an der Stirnseite des Fachbodens. Selbstklebendes Beschriftungsschild an der Abkantung der Buchstütze möglich. Gesondert zu bestellen.

Höhe
mm

Bücher auf der linken/rechten Seite der Buchstütze

Mit/ohne Abkantung

Bestell-Nr.

200
200

Rechts
Links

Ohne
Ohne

B40553490

-

B40553480

-

200
200

Rechts
Links

Mit
Mit

B40553491

-

B40553481

-

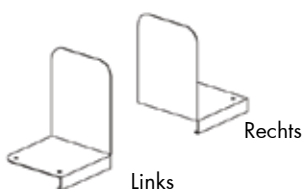

ZUBEHÖR

BESCHRIFTUNGSSCHILDER FÜR VORDERKANT DER METALL- UND HOLZFACHBÖDEN

Plastik Aufklebmschild - für S1/ST1 mit 25 mm Vorderkant

H25 mm. Kunststoff transparent. Mit weißem Beschriftungsstreifen. Verschiebbar über die Fachbodenlänge.

Breite
mm
220

Bestell-Nr.

B401135

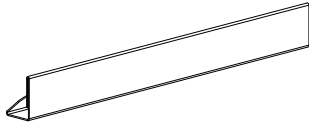

Plastik Aufklebmschild - für S2/ST2

H25 mm. Kunststoff transparent. Mit weißem Beschriftungsstreifen. Verschiebbar über die Fachbodenlänge.

Breite
mm
213

Bestell-Nr.

E3381

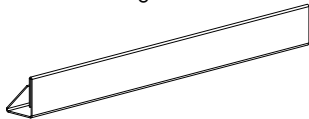

Plastik Aufklebmschild - für S3/S4/W3/W4/WB3/WB4

H21 mm. Kunststoff transparent, anti-reflex. Mit weißem Beschriftungsstreifen. Zum Aufkleben auf Metall-/Holzfachböden mit unterseitiger Nut. Verschiebbar über die Fachbodenlänge.

Breite
mm
105 Aufklebmschild
210 Aufklebmschild
104 Beschriftungsscheine (13 Stück)
209 Beschriftungsscheine (13 Stück)

Bestell-Nr.

B4017102
B4017106
B4017111
B4017116

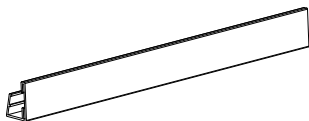

Plastik Aufklebmschild - für ST3 & S4

H50 mm. Kunststoff transparent, anti-reflex. Mit weißem Beschriftungsstreifen. Zum Aufkleben auf Metall-/Holzfachböden mit unterseitiger Nut. Verschiebbar über die Fachbodenlänge.

Achismaß
mm
500 Aufklebmschild
750 Aufklebmschild
900 Aufklebmschild
1000 Aufklebmschild
500 Beschriftungsscheine
750 Beschriftungsscheine
900 Beschriftungsscheine
1000 Beschriftungsscheine

Bestell-Nr.

B40114455
B40114457
B40114459
B40114451
B40114555
B40114557
B40114559
B40114551

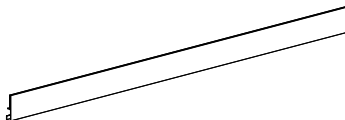

BESCHRIFTUNGSSCHILDER FÜR VORDERKANTE DER METALL- UND HOLZFACHBÖDEN

Selbstklebendes Plastik Beschriftungsschild - für S1/S2/S3/S4/ST1/ST2/ST3

H20 mm. Kunststoff transparent, anti-reflex. Mit weißem Beschriftungsstreifen.

Breite
mm

Bestell-Nr.

147
200

B4017124
B4017125

-
-

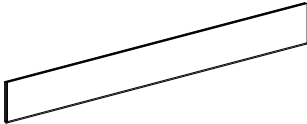

Plastik Magnetschild - für S1/S2/S3/S4/ST2/ST3

H20 mm. Kunststoffabdeckung transparent, antireflex. Mit weißem Beschriftungsstreifen. Für Metallfachböden mit glatter Kante.

Breite
mm

Bestell-Nr.

210 Magnetschild
209 Beschriftungsscheine (13 Stück)

B4017147
B4017116

-
-

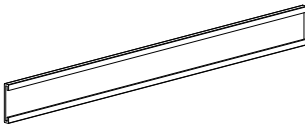

Magnetisches Etikett - für ST1 mit 47 mm Vorderkant

H40 mm. Schwarz. Für Metallfachböden mit glatter Kante.

Width
mm

Bestell-Nr.

300

B4000020300

-

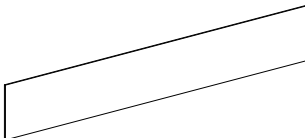

Metallbeschriftungsträger

H26 x B150 x TD150. Kunststoffabdeckung transparent, antireflex, mit weißem Beschriftungsstreifen. Universell einsetzbar durch einfaches Auflegen auf den Fachboden.

Bestell-Nr.

B401801

-

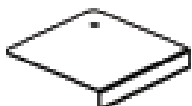

ZUBEHÖR

BESCHRIFTUNGSTAFEL

Beschriftungstafel für Holzseite mit Acrylabdeckung

Mit Schrauben an der Seitenverkleidung befestigt. Das Beschriftungstafel hat eine Acrylabdeckung zum Einschleiben des Textblattes.

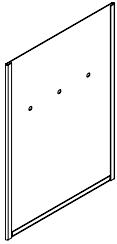

A4 vertikal / Hochformat
A3 vertikal / Hochformat
A3 horizontal / Querformat

Bestell-Nr.

B40110377	-
B40110378	-
B40110379	-



ROLLEN

ROLLENSET & BODENPLATTE MIT ROLLEN



Max. 3 Sektionen aneinander können auf Rollen montiert werden.

Rollenset für doppelseitig Regal

2 Rahmen und 4 Ø75 mm Rollen. Benützen mit doppelseitige Stirnseitungen WP1, WP2, WP3, WP4 und Rückwände WPB1/WBP2. Maks. Höhe 1520 mm. Bestellen mindestens ein Rollenset mit Bremsen.

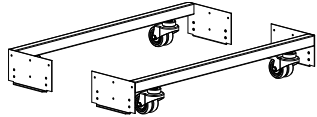

Achsmaß mm	x Rollen mit Feststeller	Bestell-Nr.	
500	0	BN06050	-
500	2	BN06051	-
750	0	BN06070	-
750	2	BN06071	-
900	0	BN06090	-
900	2	BN06091	-
1000	0	BN06010	-
1000	2	BN06011	-

Rollen für Rollenset

Ersatzteil. H112 mm, Ø75 mm. Maks. 90 kg pro Rolle.

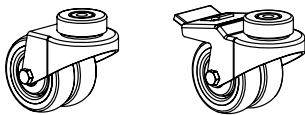

Art	Bestell-Nr.	
Ohne Feststeller	B7860100	-
Mit Feststeller	B7860101	-

Rollenset für doppelseitig Regal - mit Metallsockel & verdeckten Rollen

2 x Rahmen, 4 x Ø35 mm Rollen ohne Feststeller und 2 Metallsockel. Benützen mit doppelseitige Stirnseitungen WP1, WP2, WP3, WP4 and Rückwände WPB1/WBP2. Maks. Höhe 1520 mm.

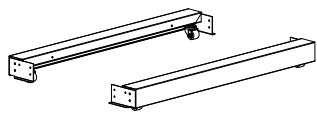

Achsmaß mm	Bestell-Nr.	
500	BN0615	-
750	BN0617	-
900	BN0619	-
1000	BN0611	-

Rollen für Rollenset mit verdeckten Rollen

Spare part. H50 mm, Ø35 mm. Maks. 100 kg pro Rolle.

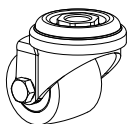

Art	Bestell-Nr.	
Ohne Feststeller	B301017	-

ROLLEN

BODENPLATTE MIT ROLLEN

Lackierte und furnierte Lingo Rollenplatten haben das FSC Zertifikat.

Doppelseitig Holz Bodenplatte mit Rollen

Mit 4/6/8 Ø75 mm Rollen, davon 2 mit Feststeller. Benützen mit doppelseitig Seitenverkleidung für Bodenplatte mit Rollen WP5/WP6/WP7/WP8 und WPB3/WBP4. Maks. Höhe 1520 mm.

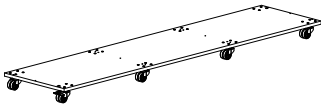

Achsmaß mm	Tiefe mm	Anzahl Sektionen	Bestell-Nr.	Melamin	Lackiert	Furniert
500	250	1	BN050451.	-	-	-
500	250	2	BN050452.	-	-	-
500	250	3	BN050453.	-	-	-
500	300	1	BN050651.	-	-	-
500	300	2	BN050652.	-	-	-
500	300	3	BN050653.	-	-	-
500	400	1	BN050851.	-	-	-
500	400	2	BN050852.	-	-	-
500	400	3	BN050853.	-	-	-
750	250	1	BN050471.	-	-	-
750	250	2	BN050472.	-	-	-
750	250	3	BN050473.	-	-	-
750	300	1	BN050671.	-	-	-
750	300	2	BN050672.	-	-	-
750	300	3	BN050673.	-	-	-
750	400	1	BN050871.	-	-	-
750	400	2	BN050872.	-	-	-
750	400	3	BN050873.	-	-	-
900	250	1	BN050491.	-	-	-
900	250	2	BN050492.	-	-	-
900	300	1	BN050691.	-	-	-
900	300	2	BN050692.	-	-	-
900	400	1	BN050891.	-	-	-
900	400	2	BN050892.	-	-	-
1000	250	1	BN050411.	-	-	-
1000	250	2	BN050412.	-	-	-
1000	300	1	BN050611.	-	-	-
1000	300	2	BN050612.	-	-	-
1000	400	1	BN050811.	-	-	-
1000	400	2	BN050812.	-	-	-

Rollen für Bodenplatte

Ersatzteil. H102 mm, Ø75 mm. Maks. 100 kg pro Rolle.

Art

Bestell-Nr.

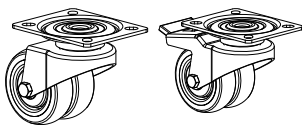

Ohne Feststeller

B400001025

Mit Feststeller

B400001125

SOCKEL

SOCKEL AUS HOLZ UND METALL

Lackierte und furnierte Lingo Sockel haben das FSC Zertifikat.

Holzsockel

Mit Snapfix. H71 mm.
Nicht mit Rollen zu verwenden.

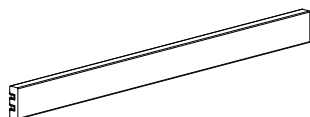

Achs-
maß
mm

500

750

900

1000

Bestell-Nr.

BN0255.

BN0257.

BN0259.

BN0251.

Melamin

-

-

-

-

Lackiert

-

-

-

-

Furniert

-

-

-

-

Metallsockel

Mit Schrauben. H71 mm.
Nicht mit Rollen zu verwenden.

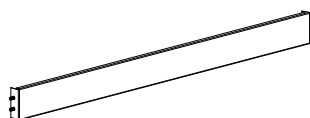

Achs-
maß
mm

500

750

900

1000

Bestell-Nr.

BN0275

BN0277

BN0279

BN0271

Stiel

-

-

-

-

HOLZSEITEN

EINSEITIG - MIT STELLFÜSSEN - FÜR METALL- UND HOLZABDECKBÖDEN

Lackierte und furnierte Lingo Holzseiten haben das FSC Zertifikat.

WP1 - einseitige, linke Holzseite mit Stellfüßen - für ST1/ST2/ST3 und WT1

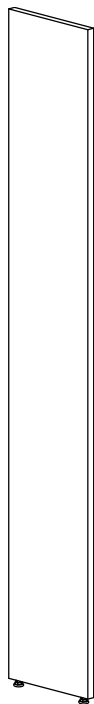

Höhe mm	FB Tiefe mm	Bestell-Nr.	Melamin	Lackiert	Furniert
720	250	BN0014232.	-	-	-
720	300	BN0014252.	-	-	-
720	400	BN0014272.	-	-	-
920	250	BN0014332.	-	-	-
920	300	BN0014352.	-	-	-
920	400	BN0014372.	-	-	-
1220	250	BN0014432.	-	-	-
1220	300	BN0014452.	-	-	-
1220	400	BN0014472.	-	-	-
1520	250	BN0014532.	-	-	-
1520	300	BN0014552.	-	-	-
1520	400	BN0014572.	-	-	-
1820	250	BN0014632.	-	-	-
1820	300	BN0014652.	-	-	-
1820	400	BN0014672.	-	-	-
2120	250	BN0014732.	-	-	-
2120	300	BN0014752.	-	-	-
2120	400	BN0014772.	-	-	-

WP1 - einseitige, mittlere Holzseite mit Stellfüßen - für ST1/ST2/ST3 und WT1

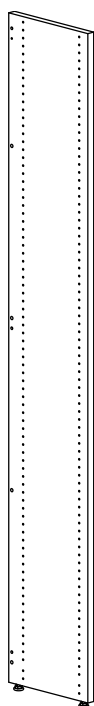

Höhe mm	FB Tiefe mm	Bestell-Nr.	Melamin	Lackiert	Furniert
720	250	BN0014234.	-	-	-
720	300	BN0014254.	-	-	-
720	400	BN0014274.	-	-	-
920	250	BN0014334.	-	-	-
920	300	BN0014354.	-	-	-
920	400	BN0014374.	-	-	-
1220	250	BN0014434.	-	-	-
1220	300	BN0014454.	-	-	-
1220	400	BN0014474.	-	-	-
1520	250	BN0014534.	-	-	-
1520	300	BN0014554.	-	-	-
1520	400	BN0014574.	-	-	-
1820	250	BN0014634.	-	-	-
1820	300	BN0014654.	-	-	-
1820	400	BN0014674.	-	-	-
2120	250	BN0014734.	-	-	-
2120	300	BN0014754.	-	-	-
2120	400	BN0014774.	-	-	-

HOLZSEITEN

EINSEITIG - MIT STELLFÜSSEN - FÜR METALL- UND HOLZABDECKBÖDEN

Lackierte und furnierte Lingo Holzseiten haben das FSC Zertifikat.

WP1 - einseitige, rechte Holzseite mit Stellfüßen - für ST1/ST2/ST3 und WT1

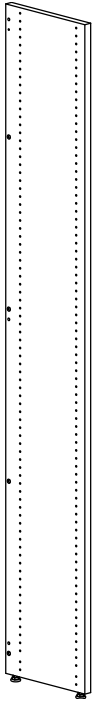

Höhe mm	FB Tiefe mm	Bestell-Nr.	Melamin	Lackiert	Furniert
720	250	BN0014233.	-	-	-
720	300	BN0014253.	-	-	-
720	400	BN0014273.	-	-	-
920	250	BN0014333.	-	-	-
920	300	BN0014353.	-	-	-
920	400	BN0014373.	-	-	-
1220	250	BN0014433.	-	-	-
1220	300	BN0014453.	-	-	-
1220	400	BN0014473.	-	-	-
1520	250	BN0014533.	-	-	-
1520	300	BN0014553.	-	-	-
1520	400	BN0014573.	-	-	-
1820	250	BN0014633.	-	-	-
1820	300	BN0014653.	-	-	-
1820	400	BN0014673.	-	-	-
2120	250	BN0014733.	-	-	-
2120	300	BN0014753.	-	-	-
2120	400	BN0014773.	-	-	-

HOLZSEITEN

DOPPELSEITIG - MIT STELLFÜßEN - FÜR ROLLENSET, METALL- UND HOLZABDECKBÖDEN

Lackierte und furnierte Lingo Holzseiten haben das FSC Zertifikat.

WP1 - doppelseitige, äußere Holzseite mit Stellfüßen - für ST1/ST2/ST3 und WT1

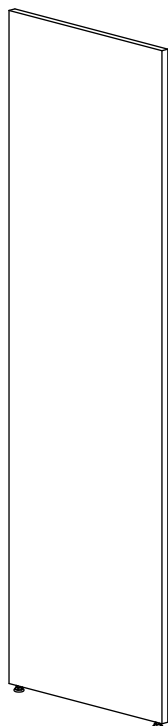

Höhe mm	FB Tiefe mm	Bestell-Nr.	Melamin	Lackiert	Furniert
720	250	BN0014245.	-	-	-
720	300	BN0014265.	-	-	-
720	400	BN0014285.	-	-	-
920	250	BN0014345.	-	-	-
920	300	BN0014365.	-	-	-
920	400	BN0014385.	-	-	-
1220	250	BN0014445.	-	-	-
1220	300	BN0014465.	-	-	-
1220	400	BN0014485.	-	-	-
1520	250	BN0014545.	-	-	-
1520	300	BN0014565.	-	-	-
1520	400	BN0014585.	-	-	-
1820	250	BN0014645.	-	-	-
1820	300	BN0014665.	-	-	-
1820	400	BN0014685.	-	-	-
2120	250	BN0014745.	-	-	-
2120	300	BN0014765.	-	-	-
2120	400	BN0014785.	-	-	-

WP1 - doppelseitige, mittlere Holzseite mit Stellfüßen - für ST1/ST2/ST3 und WT1

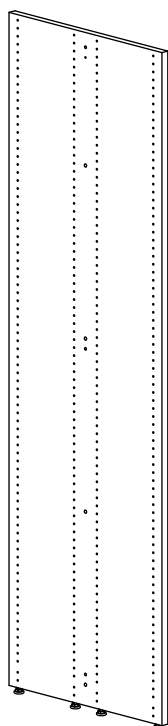

Höhe mm	FB Tiefe mm	Bestell-Nr.	Melamin	Lackiert	Furniert
720	250	BN0014244.	-	-	-
720	300	BN0014264.	-	-	-
720	400	BN0014284.	-	-	-
920	250	BN0014344.	-	-	-
920	300	BN0014364.	-	-	-
920	400	BN0014384.	-	-	-
1220	250	BN0014444.	-	-	-
1220	300	BN0014464.	-	-	-
1220	400	BN0014484.	-	-	-
1520	250	BN0014544.	-	-	-
1520	300	BN0014564.	-	-	-
1520	400	BN0014584.	-	-	-
1820	250	BN0014644.	-	-	-
1820	300	BN0014664.	-	-	-
1820	400	BN0014684.	-	-	-
2120	250	BN0014744.	-	-	-
2120	300	BN0014764.	-	-	-
2120	400	BN0014784.	-	-	-

HOLZSEITEN

DOPPELSEITIG - MIT STELLFÜSSEN - FÜR ROLLENSET, METALL- UND HOLZABDECKBÖDEN

Lackierte und furnierte Lingo Holzseiten haben das FSC Zertifikat.

WP2 - doppelseitige, äußere Lamellenwand mit Stellfüßen - für ST1/ST2/ST3 und WT1

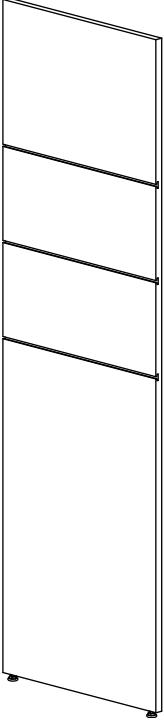
H1520 hat 2 Rillen, H1820 und 2120 haben 3 Rillen.	Höhe mm	FB Tiefe mm	Bestell-Nr.	Lackiert	Furniert	
	1520	250	BN0455451.	-	-	
	1520	300	BN0455651.	-	-	
	1520	400	BN0455851.	-	-	
	1820	250	BN0456451.	-	-	
	1820	300	BN0456651.	-	-	
	1820	400	BN0456851.	-	-	
	2120	250	BN0457451.	-	-	
	2120	300	BN0457651.	-	-	
	2120	400	BN0457851.	-	-	

HOLZSEITEN

EINSEITIG - MIT STELLFÜSSEN - FÜR HOLZABDECKPLATTE

Lackierte und furnierte Lingo Holzseiten haben das FSC Zertifikat.

WP3 - einseitige, linke Holzseite mit Stellfüßen - für WT2

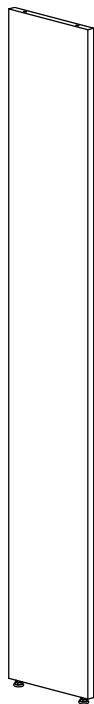

Höhe mm	FB Tiefe mm	Bestell-Nr.	Melamin	Lackiert	Furniert
720	250	BN0014236.	-	-	-
720	300	BN0014256.	-	-	-
720	400	BN0014276.	-	-	-
920	250	BN0014336.	-	-	-
920	300	BN0014356.	-	-	-
920	400	BN0014376.	-	-	-
1220	250	BN0014436.	-	-	-
1220	300	BN0014456.	-	-	-
1220	400	BN0014476.	-	-	-
1520	250	BN0014536.	-	-	-
1520	300	BN0014556.	-	-	-
1520	400	BN0014576.	-	-	-
1820	250	BN0014636.	-	-	-
1820	300	BN0014656.	-	-	-
1820	400	BN0014676.	-	-	-
2120	250	BN0014736.	-	-	-
2120	300	BN0014756.	-	-	-
2120	400	BN0014776.	-	-	-

WP3 - einseitige, mittlere Holzseite mit Stellfüßen - für WT2

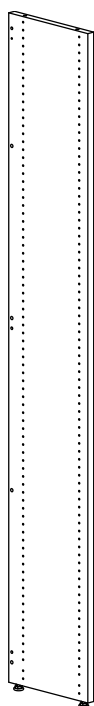

Höhe mm	FB Tiefe mm	Bestell-Nr.	Melamin	Lackiert	Furniert
720	250	BN0014238.	-	-	-
720	300	BN0014258.	-	-	-
720	400	BN0014278.	-	-	-
920	250	BN0014338.	-	-	-
920	300	BN0014358.	-	-	-
920	400	BN0014378.	-	-	-
1220	250	BN0014438.	-	-	-
1220	300	BN0014458.	-	-	-
1220	400	BN0014478.	-	-	-
1520	250	BN0014538.	-	-	-
1520	300	BN0014558.	-	-	-
1520	400	BN0014578.	-	-	-
1820	250	BN0014638.	-	-	-
1820	300	BN0014658.	-	-	-
1820	400	BN0014678.	-	-	-
2120	250	BN0014738.	-	-	-
2120	300	BN0014758.	-	-	-
2120	400	BN0014778.	-	-	-

HOLZSEITEN

EINSEITIG - MIT STELLFÜSSEN - FÜR HOLZABDECKPLATTE

Lackierte und furnierte Lingo Holzseiten haben das FSC Zertifikat.

WP3 - einseitige, rechte Holzseite mit Stellfüßen - für WT2

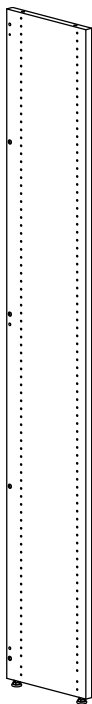

Höhe mm	FB Tiefe mm	Bestell-Nr.	Lackiert	Furniert
720	250	BN0014237.	-	-
720	300	BN0014257.	-	-
720	400	BN0014277.	-	-
920	250	BN0014337.	-	-
920	300	BN0014357.	-	-
920	400	BN0014377.	-	-
1220	250	BN0014437.	-	-
1220	300	BN0014457.	-	-
1220	400	BN0014477.	-	-
1520	250	BN0014537.	-	-
1520	300	BN0014557.	-	-
1520	400	BN0014577.	-	-
1820	250	BN0014637.	-	-
1820	300	BN0014657.	-	-
1820	400	BN0014677.	-	-
2120	250	BN0014737.	-	-
2120	300	BN0014757.	-	-
2120	400	BN0014777.	-	-

HOLZSEITEN

DOPPELSEITIG - MIT STELLFÜSSEN - FÜR ROLLENSET UND HOLZABDECKPLATTE

Lackierte und furnierte Lingo Holzseiten haben das FSC Zertifikat.

WP3 - doppelseitig außer Holzseite mit Stellfüße - for WT2

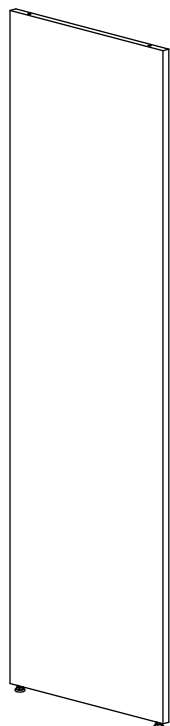

Höhe mm	FB Tiefe mm	Bestell-Nr.	Melamin	Lackiert	Furniert
720	250	BN0014249.	-	-	-
720	300	BN0014269.	-	-	-
720	400	BN0014289.	-	-	-
920	250	BN0014349.	-	-	-
920	300	BN0014369.	-	-	-
920	400	BN0014389.	-	-	-
1220	250	BN0014449.	-	-	-
1220	300	BN0014469.	-	-	-
1220	400	BN0014489.	-	-	-
1520	250	BN0014549.	-	-	-
1520	300	BN0014569.	-	-	-
1520	400	BN0014589.	-	-	-
1820	250	BN0014649.	-	-	-
1820	300	BN0014669.	-	-	-
1820	400	BN0014689.	-	-	-
2120	250	BN0014749.	-	-	-
2120	300	BN0014769.	-	-	-
2120	400	BN0014789.	-	-	-

WP3 - doppelseitig, mittlere Holzseite mit Stellfüße - für WT2

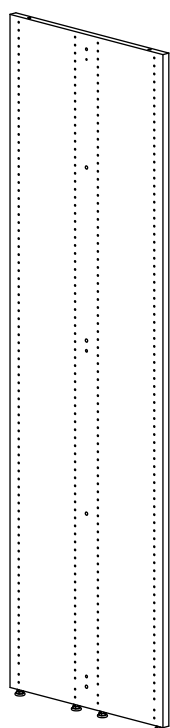

Höhe mm	FB Tiefe mm	Bestell-Nr.	Melamin	Lackiert	Furniert
720	250	BN0014248.	-	-	-
720	300	BN0014268.	-	-	-
720	400	BN0014288.	-	-	-
920	250	BN0014348.	-	-	-
920	300	BN0014368.	-	-	-
920	400	BN0014388.	-	-	-
1220	250	BN0014448.	-	-	-
1220	300	BN0014468.	-	-	-
1220	400	BN0014488.	-	-	-
1520	250	BN0014548.	-	-	-
1520	300	BN0014568.	-	-	-
1520	400	BN0014588.	-	-	-
1820	250	BN0014648.	-	-	-
1820	300	BN0014668.	-	-	-
1820	400	BN0014688.	-	-	-
2120	250	BN0014748.	-	-	-
2120	300	BN0014768.	-	-	-
2120	400	BN0014788.	-	-	-

HOLZSEITEN

DOPPELSEITIG - MIT STELLFÜSSEN - FÜR ROLLENSET UND HOLZABDECKPLATTE

Lackierte und furnierte Lingo Holzseiten haben das FSC Zertifikat.

WP4 - doppelseitig außer Lamellenwand mit Stellfüße - für WT2

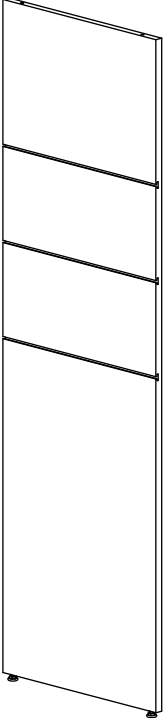
H1520 hat 2 Rillen, H1820 und 2120 haben 3 Rillen	Höhe mm	FB Tiefe mm	Bestell-Nr.	Lackiert	Furniert
	1520	250	BN0455491.	-	-
	1520	300	BN0455691.	-	-
	1520	400	BN0455891.	-	-
	1820	250	BN0456491.	-	-
	1820	300	BN0456691.	-	-
	1820	400	BN0456891.	-	-
	2120	250	BN0457491.	-	-
	2120	300	BN0457691.	-	-
	2120	400	BN0457891.	-	-

HOLZSEITEN

DOPPELSEITIG - FÜR BODENPLATTE MIT ROLLEN UND METALL- UND HOLZABDECKFACHBODEN

Lackierte und furnierte Lingo Holzseiten haben das FSC Zertifikat.

WP5 - doppelseitige, äußere Holzseite für Bodenplatte mit Rollen - für ST1/ST2/ST3 und WT1

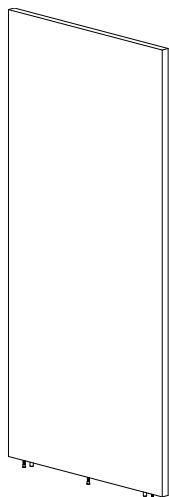

Höhe mm	FB Tiefe mm	Bestell-Nr.	Melamin	Lackiert	Furniert
720	250	BN0015245.	-	-	-
720	300	BN0015265.	-	-	-
720	400	BN0015285.	-	-	-
920	250	BN0015345.	-	-	-
920	300	BN0015365.	-	-	-
920	400	BN0015385.	-	-	-
1220	250	BN0015445.	-	-	-
1220	300	BN0015465.	-	-	-
1220	400	BN0015485.	-	-	-
1520	250	BN0015545.	-	-	-
1520	300	BN0015565.	-	-	-
1520	400	BN0015585.	-	-	-

WP5 - doppelseitige, mittlere Holzseite für Bodenplatte mit Rollen - für ST1/ST2/ST3 und WT1

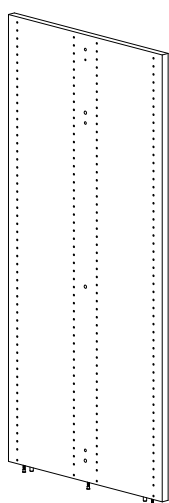

Höhe mm	FB Tiefe mm	Bestell-Nr.	Melamin	Lackiert	Furniert
720	250	BN0015244.	-	-	-
720	300	BN0015264.	-	-	-
720	400	BN0015284.	-	-	-
920	250	BN0015344.	-	-	-
920	300	BN0015364.	-	-	-
920	400	BN0015384.	-	-	-
1220	250	BN0015444.	-	-	-
1220	300	BN0015464.	-	-	-
1220	400	BN0015484.	-	-	-
1520	250	BN0015544.	-	-	-
1520	300	BN0015564.	-	-	-
1520	400	BN0015584.	-	-	-

HOLZSEITEN

DOPPELSEITIG - FÜR BODENPLATTE MIT ROLLEN UND METALL- UND HOLZABDECKFACHBODEN

Lackierte und furnierte Lingo Holzseiten haben das FSC Zertifikat.

WP6 - doppelseitige, äußere Lamellenwand für Bodenplatte mit Rollen - für ST1/ST2/ST3 und WT1

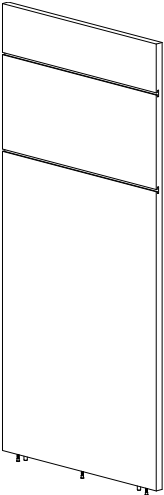
H1520 hat 2 Rillen.	Höhe mm	FB Tiefe mm	Bestell-Nr.	Lackiert	Furniert
	1520	250	BN0465451.	-	-
	1520	300	BN0465651.	-	-
	1520	400	BN0465851.	-	-

HOLZSEITEN

DOPPELSEITIG - FÜR BODENPLATTE MIT ROLLEN UND HOLZABDECKPLATTE

Lackierte und furnierte Lingo Holzseiten haben das FSC Zertifikat.

WP7 - doppelseitige, äußere Holzseite für Bodenplatte mit Rollen - für WT2

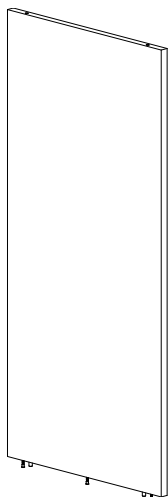

Höhe mm	FB Tiefe mm	Bestell-Nr.	Melamin	Lackiert	Furniert
720	250	BN0015249.	-	-	-
720	300	BN0015269.	-	-	-
720	400	BN0015289.	-	-	-
920	250	BN0015349.	-	-	-
920	300	BN0015369.	-	-	-
920	400	BN0015389.	-	-	-
1220	250	BN0015449.	-	-	-
1220	300	BN0015469.	-	-	-
1220	400	BN0015489.	-	-	-
1520	250	BN0015549.	-	-	-
1520	300	BN0015569.	-	-	-
1520	400	BN0015589.	-	-	-

WP7 - doppelseitige, mittlere Holzseite für Bodenplatte mit Rollen - für WT2

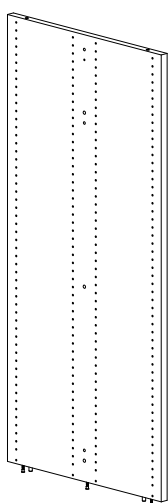

Höhe mm	FB Tiefe mm	Bestell-Nr.	Melamin	Lackiert	Furniert
720	250	BN0015248.	-	-	-
720	300	BN0015268.	-	-	-
720	400	BN0015288.	-	-	-
920	250	BN0015348.	-	-	-
920	300	BN0015368.	-	-	-
920	400	BN0015388.	-	-	-
1220	250	BN0015448.	-	-	-
1220	300	BN0015468.	-	-	-
1220	400	BN0015488.	-	-	-
1520	250	BN0015548.	-	-	-
1520	300	BN0015568.	-	-	-
1520	400	BN0015588.	-	-	-

HOLZSEITEN

DOPPELSEITIG - FÜR BODENPLATTE MIT ROLLEN UND HOLZABDECKPLATTE

Lackierte und furnierte Lingo Holzseiten haben das FSC Zertifikat.

WP8 - doppelseitige, äußere Lamellenwand für Bodenplatte mit Rollen - für WT2

H1520 hat 2 Rillen.	Höhe mm	FB Tiefe mm	Bestell-Nr.	Lackiert	Furniert
	1520	250	BN0465491.	-	-
	1520	300	BN0465691.	-	-
	1520	400	BN0465891.	-	-

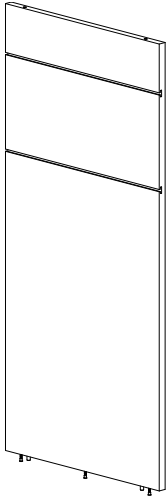

HOLZSEITEN

FUNKTIONSSEITE

Die Holzfunksionsseiten dienen als zusätzliche Präsentations- und Aufbewahrungsfläche für das Regalsystem Lingo. Diese Stirnseitenregale können problemlos nachträglich an vorhandenen doppelseitigen Regalen montiert werden. (vorhandene Seitenwand durch Funktionsseite ersetzen) Lackierte und furnierte Lingo Holzseiten haben das FSC Zertifikat.

Holzfunksionsseite - für Regal mit Abdeckboden

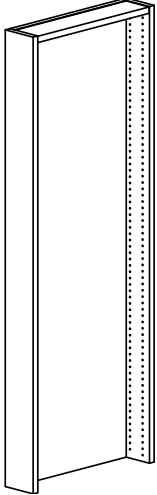
Mit Befestigungsmaterial.	Height mm	FB Tiefe mm	Breite mm	Bestell-Nr.	Melamin	Lackiert	Furniert
	720	250	498	BN5402A1.	-	-	-
	720	300	598	BN5402B1.	-	-	-
	720	400	798	BN5402C1.	-	-	-
	920	250	498	BN5403A1.	-	-	-
	920	300	598	BN5403B1.	-	-	-
	920	400	798	BN5403C1.	-	-	-
	1220	250	498	BN5404A1.	-	-	-
	1220	300	598	BN5404B1.	-	-	-
	1220	400	798	BN5404C1.	-	-	-
	1520	250	498	BN5405A1.	-	-	-
	1520	300	598	BN5405B1.	-	-	-
	1520	400	798	BN5405C1.	-	-	-
	1820	250	498	BN5406A1.	-	-	-
	1820	300	598	BN5406B1.	-	-	-
	1820	400	798	BN5406C1.	-	-	-
	2120	250	498	BN5407A1.	-	-	-
	2120	300	598	BN5407B1.	-	-	-
	2120	400	798	BN5407C1.	-	-	-

Holzfunksionsseite - für Regal mit Abdeckplatte

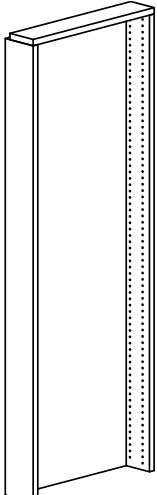
Mit Befestigungsmaterial.	Height mm	FB Tiefe mm	Breite mm	Bestell-Nr.	Melamin	Lackiert	Furniert
	720	250	498	BN5402A2.	-	-	-
	720	300	598	BN5402B2.	-	-	-
	720	400	798	BN5402C2.	-	-	-
	920	250	498	BN5403A2.	-	-	-
	920	300	598	BN5403B2.	-	-	-
	920	400	798	BN5403C2.	-	-	-
	1220	250	498	BN5404A2.	-	-	-
	1220	300	598	BN5404B2.	-	-	-
	1220	400	798	BN5404C2.	-	-	-
	1520	250	498	BN5405A2.	-	-	-
	1520	300	598	BN5405B2.	-	-	-
	1520	400	798	BN5405C2.	-	-	-
	1820	250	498	BN5406A2.	-	-	-
	1820	300	598	BN5406B2.	-	-	-
	1820	400	798	BN5406C2.	-	-	-
	2120	250	498	BN5407A2.	-	-	-
	2120	300	598	BN5407B2.	-	-	-
	2120	400	798	BN5407A2.	-	-	-

Die folgenden Zubehörteile passen in die Stirnseitenregale. Lackierte und furnierte Lingo Komponenten haben das FSC Zertifikat.

Beschriftungsschild aus Holzwerkstoff für Funktionsseite

H368 mm. Mit Befestigungsmaterial.	Breite mm	FB Tiefe mm	Bestell-Nr.	Melamin	Lackiert	Furniert
	498	250	BN541A.	-	-	-
	598	300	BN541B.	-	-	-
	798	400	BN541C.	-	-	-

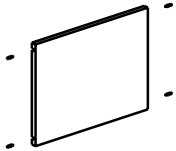

Präsentationsboden aus Metall für Funktionsseite

H280 mm. Mit Befestigungsmaterial.	Breite mm	FB Tiefe mm	Bestell-Nr.	Metall
	498	250	BN542A	-
	598	300	BN542B	-
	798	400	BN542C	-

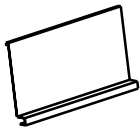

Folderleiste aus Holzwerkstoff für Funktionsseite

H140 mm. Mit Befestigungsmaterial. Front und drei herausnehmbare Fachteiler aus transparentem Acrylglas.	Breite mm	FB Tiefe mm	Bestell-Nr.	Melamin	Lackiert	Furniert
	498	250	BN543A.	-	-	-
	598	300	BN543B.	-	-	-
	798	400	BN543C.	-	-	-

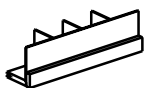

VERBINDUNGSELEMENTE

HOLZRÜCKWAND - FÜR STELLFÜßE/ROLLENSET

Lackierte und furnierte Lingo Rückwände haben das FSC Zertifikat.

WBP1 - Holzrückwand (hoch) - for ST1 (Standardtiefe)/ST2/ST3/WT1 (Standardtiefe)/WT2

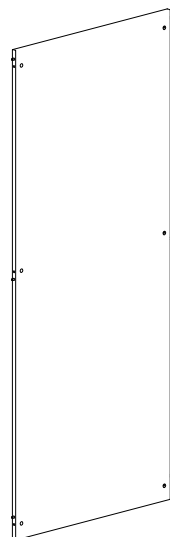

Höhe mm	Achsmaß mm	Bestell-Nr.	Melamin	Lackiert	Furniert
720	500	BN015254.	-	-	-
720	750	BN015274.	-	-	-
720	900	BN015294.	-	-	-
720	1000	BN015214.	-	-	-
920	500	BN015354.	-	-	-
920	750	BN015374.	-	-	-
920	900	BN015394.	-	-	-
920	1000	BN015314.	-	-	-
1220	500	BN015454.	-	-	-
1220	750	BN015474.	-	-	-
1220	900	BN015494.	-	-	-
1220	1000	BN015414.	-	-	-
1520	500	BN015554.	-	-	-
1520	750	BN015574.	-	-	-
1520	900	BN015594.	-	-	-
1520	1000	BN015514.	-	-	-
1820	500	BN015654.	-	-	-
1820	750	BN015674.	-	-	-
1820	900	BN015694.	-	-	-
1820	1000	BN015614.	-	-	-
2120	500	BN015754.	-	-	-
2120	750	BN015774.	-	-	-
2120	900	BN015794.	-	-	-
2120	1000	BN015714.	-	-	-

WBP2 - Holzrückwand (niedrig) - for ST1 (Volltiefe & doppel)/WT1 (Volltiefe & doppel)

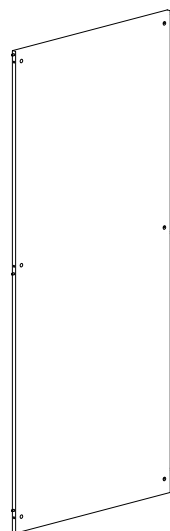

Höhe mm	Achsmaß mm	Bestell-Nr.	Melamin	Lackiert	Furniert
720	500	BN015256.	-	-	-
720	750	BN015276.	-	-	-
720	900	BN015296.	-	-	-
720	1000	BN015216.	-	-	-
920	500	BN015356.	-	-	-
920	750	BN015376.	-	-	-
920	900	BN015396.	-	-	-
920	1000	BN015316.	-	-	-
1220	500	BN015456.	-	-	-
1220	750	BN015476.	-	-	-
1220	900	BN015496.	-	-	-
1220	1000	BN015416.	-	-	-
1520	500	BN015556.	-	-	-
1520	750	BN015576.	-	-	-
1520	900	BN015596.	-	-	-
1520	1000	BN015516.	-	-	-
1820	500	BN015656.	-	-	-
1820	750	BN015676.	-	-	-
1820	900	BN015696.	-	-	-
1820	1000	BN015616.	-	-	-
2120	500	BN015756.	-	-	-
2120	750	BN015776.	-	-	-
2120	900	BN015796.	-	-	-
2120	1000	BN015716.	-	-	-

VERBINDUNGSELEMENTE

HOLZRÜCKWAND - FÜR BODENPLATTE MIT ROLLEN

Lackierte und furnierte Lingo Rückwände haben das FSC Zertifikat.

WBP3 - Holzrückwand (hoch) - for ST1 (Standardtiefe)/ST2/ST3/WT1 (Standardtiefe)/WT2

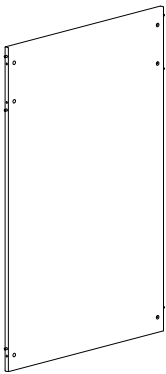
	Höhe mm	Achsmaß mm	Bestell-Nr.	Melamin	Lackiert	Furniert
	720	500	BN016254.	-	-	-
	720	750	BN016274.	-	-	-
	720	900	BN016294.	-	-	-
	720	1000	BN016214.	-	-	-
	920	500	BN016354.	-	-	-
	920	750	BN016374.	-	-	-
	920	900	BN016394.	-	-	-
	920	1000	BN016314.	-	-	-
	1220	500	BN016454.	-	-	-
	1220	750	BN016474.	-	-	-
	1220	900	BN016494.	-	-	-
	1220	1000	BN016414.	-	-	-
	1520	500	BN016554.	-	-	-
	1520	750	BN016574.	-	-	-
	1520	900	BN016594.	-	-	-
	1520	1000	BN016514.	-	-	-

WBP4 - Holzrückwand (niedrig) - for ST1 (Volltiefe & doppel)/WT1 (Volltiefe & doppel)

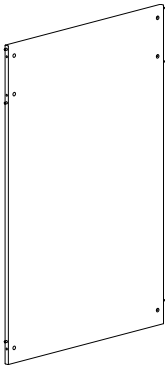
	Höhe mm	Achsmaß mm	Bestell-Nr.	Melamin	Lackiert	Furniert
	720	500	BN016256.	-	-	-
	720	750	BN016276.	-	-	-
	720	900	BN016296.	-	-	-
	720	1000	BN016216.	-	-	-
	920	500	BN016356.	-	-	-
	920	750	BN016376.	-	-	-
	920	900	BN016396.	-	-	-
	920	1000	BN016316.	-	-	-
	1220	500	BN016456.	-	-	-
	1220	750	BN016476.	-	-	-
	1220	900	BN016496.	-	-	-
	1220	1000	BN016416.	-	-	-
	1520	500	BN016556.	-	-	-
	1520	750	BN016576.	-	-	-
	1520	900	BN016596.	-	-	-
	1520	1000	BN016516.	-	-	-

VERBINDUNGSELEMENTE

METALLRAHMENRAVERSE

Um die Stabilität zu gewährleisten, muß in doppelseitige Regalen H1820 und H2120 eine zusätzliche Rahmentraverse montiert werden, je nach Länge der Regalreihen. Konfigurationen für freistehende Sektionen beinhalten eine zusätzliche Rahmentraverse. Rahmentraversen für mittlere Sektionen sind gemäß der Übersicht auf Seite 11 extra zu bestellen.

Metallrahmentraverse - niedrig

Für Höhe 720/920/1220/
1820/2120 mm. Mit
Befestigungsmaterial.

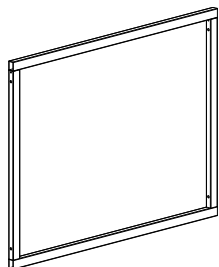

Achsmaß mm	Sektion	Bestell-Nr.	
500	Freistehend	BN01054ZZZ8	-
750	Freistehend	BN01074ZZZ8	-
900	Freistehend	BN01094ZZZ8	-
1000	Freistehend	BN01014ZZZ8	-
500	Mittlere	BN01054ZZZ9	-
750	Mittlere	BN01074ZZZ9	-
900	Mittlere	BN01094ZZZ9	-
1000	Mittlere	BN01014ZZZ9	-

Zusätzliche Metallrahmentraverse - niedrig

Für die notwendige Stabilität
bei mehreren Sektionen zu
verwenden, gemäß Übersicht
auf Seite 11. Mit Befestigungs-
material.

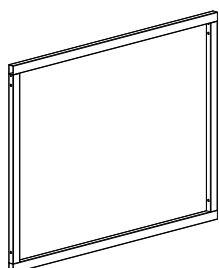

Achsmaß mm	Sektion	Bestell-Nr.	
500	Freistehend	BN01254ZZZ3	-
750	Freistehend	BN01274ZZZ3	-
900	Freistehend	BN01294ZZZ3	-
1000	Freistehend	BN01214ZZZ3	-
500	Mittlere	BN01254ZZZ2	-
750	Mittlere	BN01274ZZZ2	-
900	Mittlere	BN01294ZZZ2	-
1000	Mittlere	BN01214ZZZ2	-
500	Äußere	BN01254ZZZ1	-
750	Äußere	BN01274ZZZ1	-
900	Äußere	BN01294ZZZ1	-
1000	Äußere	BN01214ZZZ1	-

VERBINDUNGSELEMENTE

DIAGONALTRAVERSE

Galvanisierte Diagonaltraverse - niedrig

Für Höhe: 720/920/1220 mm.

Achsmaß
mm

Bestell-Nr.

500

BN02154

-

750

BN02174

-

900

BN02194

-

1000

BN02114

-

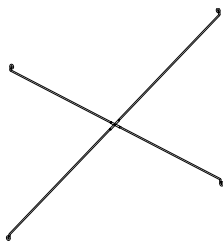

Galvanisierte Diagonaltraverse - hoch

Für Höhe: 1520/1820/2120 mm. Wenn Diagonaltraversen verwendet werden, muß ein Zwischenfachboden pro Sektion mit den Holzseiten verschraubt werden.

Achsmaß
mm

Bestell-Nr.

500

BN02156

-

750

BN02176

-

900

BN02196

-

1000

BN02116

-

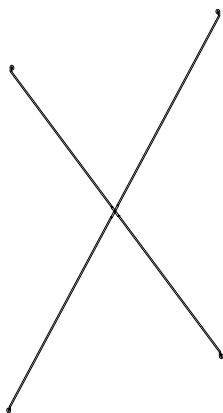



Die Armatur für die Book LED-Regalbeleuchtung kann an den Holz-Abdeckböden befestigt werden und kann mittels Verbindungsmaterialien über 1, 2 und 3 Sektionen hin montiert werden. Durchgehendes Funktionieren erfordert ebenfalls eine Verbindungsmontage.
Die Armatur hat das CE-Prüfzeichen und standardmäßig in Weiß und Stahl erhältlich. Für andere Farben fragen Sie bitte unseren Kundendienst.

Armature

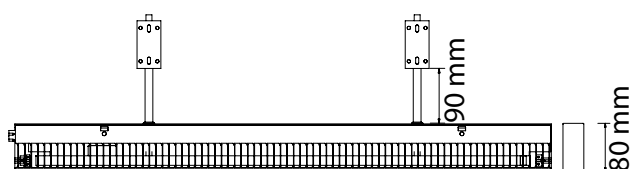

Für 2 Tragarme mit LED und Belüftung.
Armatur Gehäuse in Aluminium

Tragarme



Standard-Tragarm zur Montage am Holzabdeckboden

Tragarme - für Vorderkante







Tragarm zur Montage an der Vorderkante des vorgebohrten Holzabdeckbodens

BELEUCHTUNG

BOOK LED-BELEUCHTUNG

Im Folgenden finden Sie eine Liste von Produkten, die bei der Bestellung von 1, 2 oder 3 Sektionen benötigt werden. Für 4 oder mehr Sektionen müssen Sie eine Kombination der Armaturen für 1, 2 oder 3 Sektionen verwenden, indem Sie die Armaturen mit einem Verbindungsteil zusammenfügen.

1 Sektion	Bestell-Nr.
Armatur - Achsmaß 50	B3900170527 -
Armatur - Achsmaß 75	B3900170777 -
Armatur - Achsmaß 90	B3900170927 -
Armatur - Achsmaß 100	B3900171032 -
 Tragarme, 2 St., Standard oder Tragarme, 2 St., für Vorderkante	B39001512 - B39001522 -
Endabdeckungen, 2 St.	B390011 -
2 Sektionen	Bestell-Nr.
 Armatur - Achsmaß 50 + 50	B3900171054 -
Armatur - Achsmaß 75 + 75	B3900171554 -
Armatur - Achsmaß 90 + 90	B3900171854 -
Armatur - Achsmaß 100 + 100	B3900172064 -
 Tragarme, 2 St., Standard oder Tragarme, 2 St., für Vorderkante	B39001512 - B39001522 -
Endabdeckungen, 2 St.	B390011 -
3 Sektionen	Bestell-Nr.
Armatur - Achsmaß 50 + 50 + 50	B3900171580 -
Armatur - Achsmaß 75 + 75 + 75	B3900172330 -
Armatur - Achsmaß 90 + 90 + 90	B3900172780 -
Armatur - Achsmaß 100 + 100 + 100	B3900173095 -
 Tragarme, 3 St., Standard oder Tragarme, 3 St., für Vorderkante	B39001513 - B39001523 -
Endabdeckungen, 2 St.	B390011 -
Kabel 3 x 1.5 mm ² , L2500 mm	Bestell-Nr.
	B390013 -
Verbindungsmaterial	Bestell-Nr.
	B390012 -

LINGO ROUND SHELVING SYSTEM

BBN201 - 26° - STEEL BACK FRAME - ADJUSTABLE FEET - FOR TOP SHELF



LINGO ROUND SHELVING SYSTEM

BBN201 - 26° - STEEL BACK FRAME - ADJUSTABLE FEET - FOR TOP SHELF

Round shelving system with wooden panels and steel back frame. To be used with top shelf.
Freestanding bay includes 2 end wooden panels and 1 or 2 steel back frame depending on height.
Intermediate bay includes 1 intermediate wooden panel and 1 steel back frame.

- Prices based on steel price group 1 and wooden price group A (see Design Options pages 6-9).
- For top shelves, see from page 340
- For shelves, see from page 328

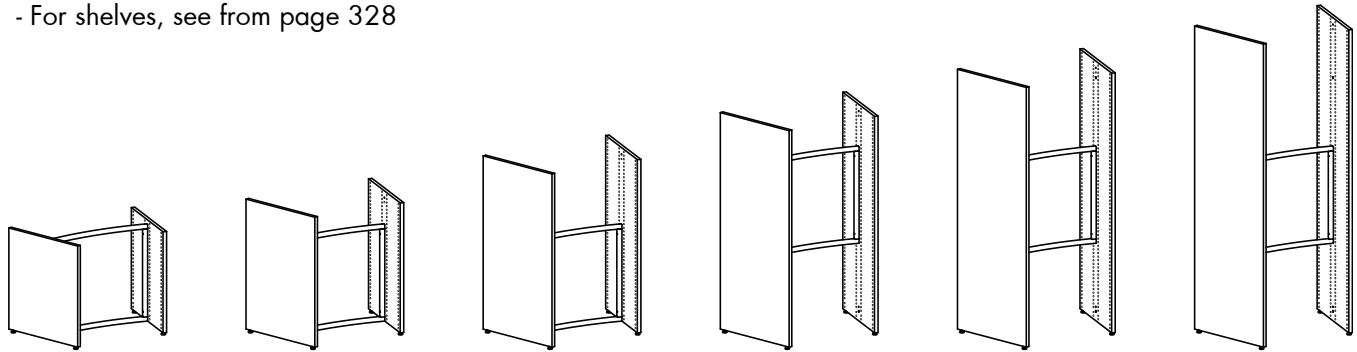

Double-sided freestanding bay - H720/920/1220/1520/1820/2120 mm

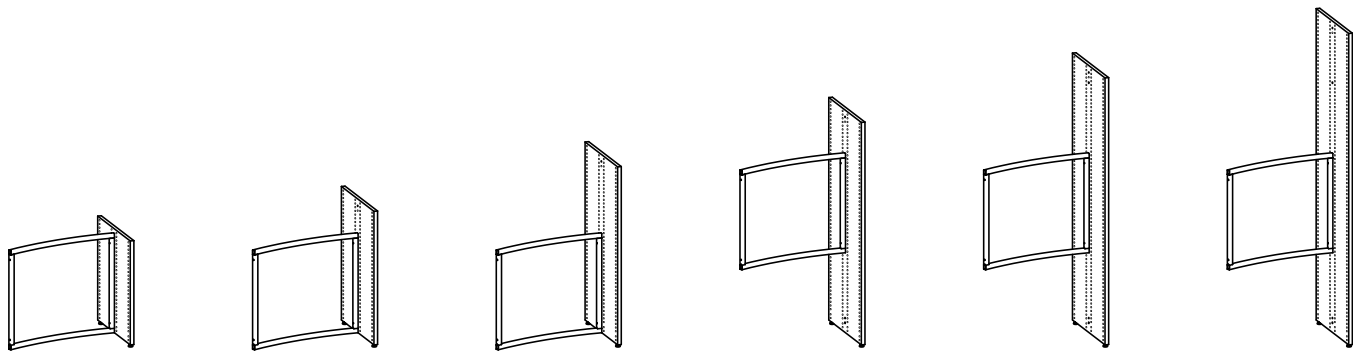

Double-sided intermediate bay - H720/920/1220/1520/1820/2120 mm

LINGO ROUND SHELVING SYSTEM

26° - STEEL BACK FRAME - ADJUSTABLE FEET - FOR TOP SHELF

Painted and veneered Lingo Shelving Systems are FSC-certified.

H720 mm

No. of bays	Item no. Freestanding bay	Melamine EUR	Painted EUR	Veneer EUR	Item no. Intermediate bay	Melamine EUR	Painted EUR	Veneer EUR
1	BBN2011260100060.	-	-	-	BBN2014260100060.	-	-	-
2	BBN2011260200060.	-	-	-	BBN2014260200060.	-	-	-
3	BBN2011260300060.	-	-	-	BBN2014260300060.	-	-	-
4	BBN2011260400060.	-	-	-	BBN2014260400060.	-	-	-
5	BBN2011260500060.	-	-	-	BBN2014260500060.	-	-	-
6	BBN2011260600060.	-	-	-	BBN2014260600060.	-	-	-
7	BBN2011260700060.	-	-	-	BBN2014260700060.	-	-	-
8	BBN2011260800060.	-	-	-				
9	BBN2011260900060.	-	-	-				
10	BBN2011261000060.	-	-	-				
11	BBN2011261100060.	-	-	-				
12	BBN2011261200060.	-	-	-				

H920 mm

No. of bays	Item no. Freestanding bay	Melamine EUR	Painted EUR	Veneer EUR	Item no. Intermediate bay	Melamine EUR	Painted EUR	Veneer EUR
1	BBN2011360100060.	-	-	-	BBN2014360100060.	-	-	-
2	BBN2011360200060.	-	-	-	BBN2014360200060.	-	-	-
3	BBN2011360300060.	-	-	-	BBN2014360300060.	-	-	-
4	BBN2011360400060.	-	-	-	BBN2014360400060.	-	-	-
5	BBN2011360500060.	-	-	-	BBN2014360500060.	-	-	-
6	BBN2011360600060.	-	-	-	BBN2014360600060.	-	-	-
7	BBN2011360700060.	-	-	-	BBN2014360700060.	-	-	-
8	BBN2011360800060.	-	-	-				
9	BBN2011360900060.	-	-	-				
10	BBN2011361000060.	-	-	-				
11	BBN2011361100060.	-	-	-				
12	BBN2011361200060.	-	-	-				

H1220 mm

No. of bays	Item no. Freestanding bay	Melamine EUR	Painted EUR	Veneer EUR	Item no. Intermediate bay	Melamine EUR	Painted EUR	Veneer EUR
1	BBN2011460100060.	-	-	-	BBN2014460100060.	-	-	-
2	BBN2011460200060.	-	-	-	BBN2014460200060.	-	-	-
3	BBN2011460300060.	-	-	-	BBN2014460300060.	-	-	-
4	BBN2011460400060.	-	-	-	BBN2014460400060.	-	-	-
5	BBN2011460500060.	-	-	-	BBN2014460500060.	-	-	-
6	BBN2011460600060.	-	-	-	BBN2014460600060.	-	-	-
7	BBN2011460700060.	-	-	-	BBN2014460700060.	-	-	-
8	BBN2011460800060.	-	-	-				
9	BBN2011460900060.	-	-	-				
10	BBN2011461000060.	-	-	-				
11	BBN2011461100060.	-	-	-				
12	BBN2011461200060.	-	-	-				

LINGO ROUND SHELVING SYSTEM

26° - STEEL BACK FRAME - ADJUSTABLE FEET - FOR TOP SHELF

Painted and veneered Lingo Shelving Systems are FSC-certified.

H1520 mm

No. of bays	Item no. Freestanding bay	Melamine EUR	Painted EUR	Veneer EUR	Item no. Intermediate bay	Melamine EUR	Painted EUR	Veneer EUR
1	BBN2011560100060.	-	-	-	BBN2014560100060.	-	-	-
2	BBN2011560200060.	-	-	-	BBN2014560200060.	-	-	-
3	BBN2011560300060.	-	-	-	BBN2014560300060.	-	-	-
4	BBN2011560400060.	-	-	-	BBN2014560400060.	-	-	-
5	BBN2011560500060.	-	-	-	BBN2014560500060.	-	-	-
6	BBN2011560600060.	-	-	-	BBN2014560600060.	-	-	-
7	BBN2011560700060.	-	-	-	BBN2014560700060.	-	-	-
8	BBN2011560800060.	-	-	-				
9	BBN2011560900060.	-	-	-				
10	BBN2011561000060.	-	-	-				
11	BBN2011561100060.	-	-	-				
12	BBN2011561200060.	-	-	-				

H1820 mm

No. of bays	Item no. Freestanding bay	Melamine EUR	Painted EUR	Veneer EUR	Item no. Intermediate bay	Melamine EUR	Painted EUR	Veneer EUR
1	BBN2011660100060.	-	-	-	BBN2014660100060.	-	-	-
2	BBN2011660200060.	-	-	-	BBN2014660200060.	-	-	-
3	BBN2011660300060.	-	-	-	BBN2014660300060.	-	-	-
4	BBN2011660400060.	-	-	-	BBN2014660400060.	-	-	-
5	BBN2011660500060.	-	-	-	BBN2014660500060.	-	-	-
6	BBN2011660600060.	-	-	-	BBN2014660600060.	-	-	-
7	BBN2011660700060.	-	-	-	BBN2014660700060.	-	-	-
8	BBN2011660800060.	-	-	-				
9	BBN2011660900060.	-	-	-				
10	BBN2011661000060.	-	-	-				
11	BBN2011661100060.	-	-	-				
12	BBN2011661200060.	-	-	-				

H2120 mm

No. of bays	Item no. Freestanding bay	Melamine EUR	Painted EUR	Veneer EUR	Item no. Intermediate bay	Melamine EUR	Painted EUR	Veneer EUR
1	BBN2011760100060.	-	-	-	BBN2014760100060.	-	-	-
2	BBN2011760200060.	-	-	-	BBN2014760200060.	-	-	-
3	BBN2011760300060.	-	-	-	BBN2014760300060.	-	-	-
4	BBN2011760400060.	-	-	-	BBN2014760400060.	-	-	-
5	BBN2011760500060.	-	-	-	BBN2014760500060.	-	-	-
6	BBN2011760600060.	-	-	-	BBN2014760600060.	-	-	-
7	BBN2011760700060.	-	-	-	BBN2014760700060.	-	-	-
8	BBN2011760800060.	-	-	-				
9	BBN2011760900060.	-	-	-				
10	BBN2011761000060.	-	-	-				
11	BBN2011761100060.	-	-	-				
12	BBN2011761200060.	-	-	-				

LINGO ROUND SHELVING SYSTEM

BBN201 - 26° - HIGH STEEL BACK PANEL - ADJUSTABLE FEET - FOR TOP SHELF



LINGO ROUND SHELVING SYSTEM

BBN201 - 26° - HIGH STEEL BACK PANEL - ADJUSTABLE FEET - FOR TOP SHELF

Round shelving system with wooden panels and high steel back panel.

To be used with top shelf WT5 standard depth top shelf.

Freestanding bay includes 2 wooden end panels and 1 high steel back panel.

Intermediate bay includes 1 intermediate wooden panel and 1 high steel back panel.

- Prices based on steel price group 1 and wooden price group A (see Design Options pages 6-9).

- For top shelves, see from page 340

- For shelves, see from page 328

- For castor frame, see page 347

- For end panel bay, see page 358

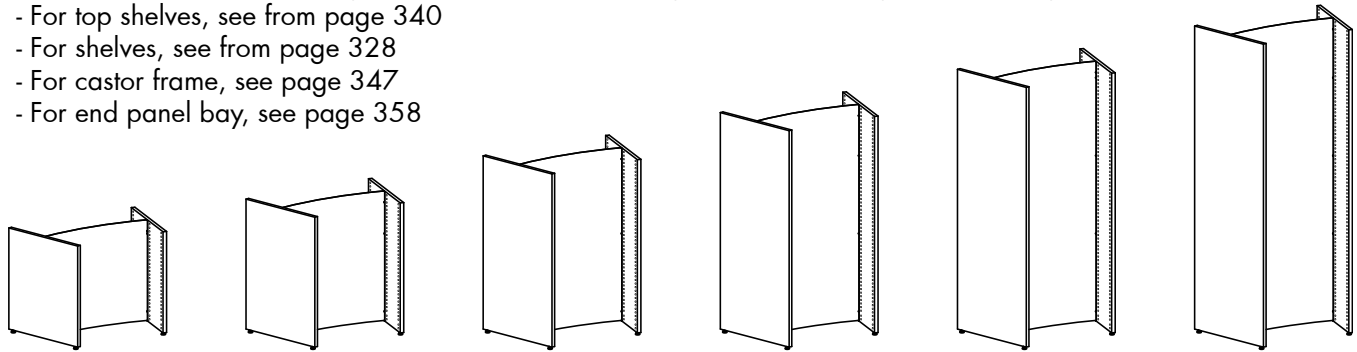

Double-sided freestanding bay - H720/920/1220/1520/1820/2120 mm

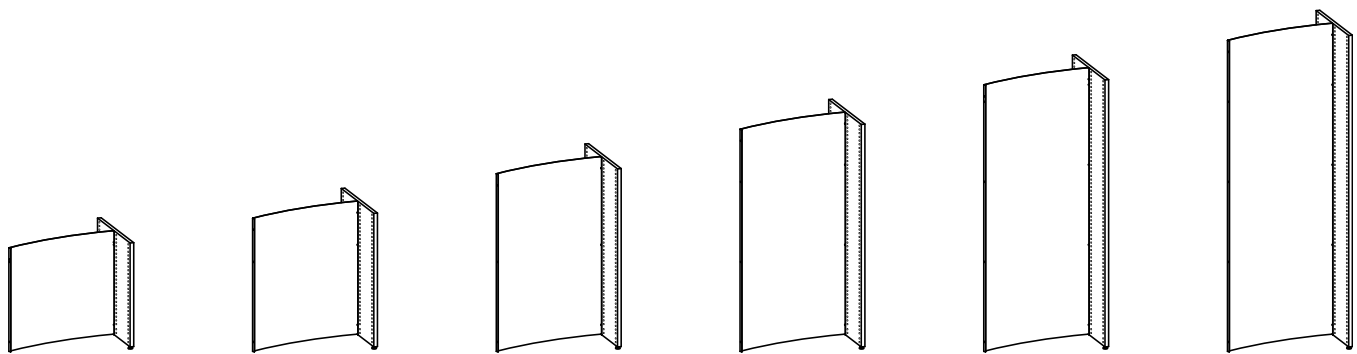

Double-sided intermediate bay - H720/920/1220/1520/1820/2120 mm

LINGO ROUND SHELVING SYSTEM

26° - HIGH STEEL BACK PANEL - ADJUSTABLE FEET - FOR TOP SHELF

Painted and veneered Lingo Shelving Systems are FSC-certified.

H720 mm

No. of bays	Item no. Freestanding bay	Melamine EUR	Painted EUR	Veneer EUR	Item no. Intermediate bay	Melamine EUR	Painted EUR	Veneer EUR
1	BBN2011260100070.	-	-	-	BBN2014260100070.	-	-	-
2	BBN2011260200070.	-	-	-	BBN2014260200070.	-	-	-
3	BBN2011260300070.	-	-	-	BBN2014260300070.	-	-	-
4	BBN2011260400070.	-	-	-	BBN2014260400070.	-	-	-
5	BBN2011260500070.	-	-	-	BBN2014260500070.	-	-	-
6	BBN2011260600070.	-	-	-	BBN2014260600070.	-	-	-
7	BBN2011260700070.	-	-	-	BBN2014260700070.	-	-	-
8	BBN2011260800070.	-	-	-				
9	BBN2011260900070.	-	-	-				
10	BBN2011261000070.	-	-	-				
11	BBN2011261100070.	-	-	-				
12	BBN2011261200070.	-	-	-				

H920 mm

No. of bays	Item no. Freestanding bay	Melamine EUR	Painted EUR	Veneer EUR	Item no. Intermediate bay	Melamine EUR	Painted EUR	Veneer EUR
1	BBN2011360100070.	-	-	-	BBN2014360100070.	-	-	-
2	BBN2011360200070.	-	-	-	BBN2014360200070.	-	-	-
3	BBN2011360300070.	-	-	-	BBN2014360300070.	-	-	-
4	BBN2011360400070.	-	-	-	BBN2014360400070.	-	-	-
5	BBN2011360500070.	-	-	-	BBN2014360500070.	-	-	-
6	BBN2011360600070.	-	-	-	BBN2014360600070.	-	-	-
7	BBN2011360700070.	-	-	-	BBN2014360700070.	-	-	-
8	BBN2011360800070.	-	-	-				
9	BBN2011360900070.	-	-	-				
10	BBN2011361000070.	-	-	-				
11	BBN2011361100070.	-	-	-				
12	BBN2011361200070.	-	-	-				

H1220 mm

No. of bays	Item no. Freestanding bay	Melamine EUR	Painted EUR	Veneer EUR	Item no. Intermediate bay	Melamine EUR	Painted EUR	Veneer EUR
1	BBN2011460100070.	-	-	-	BBN2014460100070.	-	-	-
2	BBN2011460200070.	-	-	-	BBN2014460200070.	-	-	-
3	BBN2011460300070.	-	-	-	BBN2014460300070.	-	-	-
4	BBN2011460400070.	-	-	-	BBN2014460400070.	-	-	-
5	BBN2011460500070.	-	-	-	BBN2014460500070.	-	-	-
6	BBN2011460600070.	-	-	-	BBN2014460600070.	-	-	-
7	BBN2011460700070.	-	-	-	BBN2014460700070.	-	-	-
8	BBN2011460800070.	-	-	-				
9	BBN2011460900070.	-	-	-				
10	BBN2011461000070.	-	-	-				
11	BBN2011461100070.	-	-	-				
12	BBN2011461200070.	-	-	-				

LINGO ROUND SHELVING SYSTEM

26° - HIGH STEEL BACK PANEL - ADJUSTABLE FEET - FOR TOP SHELF

Painted and veneered Lingo Shelving Systems are FSC-certified.

H1520 mm

No. of bays	Item no. Freestanding bay	Melamine EUR	Painted EUR	Veneer EUR	Item no. Intermediate bay	Melamine EUR	Painted EUR	Veneer EUR
1	BBN2011560100070.	-	-	-	BBN2014560100070.	-	-	-
2	BBN2011560200070.	-	-	-	BBN2014560200070.	-	-	-
3	BBN2011560300070.	-	-	-	BBN2014560300070.	-	-	-
4	BBN2011560400070.	-	-	-	BBN2014560400070.	-	-	-
5	BBN2011560500070.	-	-	-	BBN2014560500070.	-	-	-
6	BBN2011560600070.	-	-	-	BBN2014560600070.	-	-	-
7	BBN2011560700070.	-	-	-	BBN2014560700070.	-	-	-
8	BBN2011560800070.	-	-	-				
9	BBN2011560900070.	-	-	-				
10	BBN2011561000070.	-	-	-				
11	BBN2011561100070.	-	-	-				
12	BBN2011561200070.	-	-	-				

H1820 mm

No. of bays	Item no. Freestanding bay	Melamine EUR	Painted EUR	Veneer EUR	Item no. Intermediate bay	Melamine EUR	Painted EUR	Veneer EUR
1	BBN2011660100070.	-	-	-	BBN2014660100070.	-	-	-
2	BBN2011660200070.	-	-	-	BBN2014660200070.	-	-	-
3	BBN2011660300070.	-	-	-	BBN2014660300070.	-	-	-
4	BBN2011660400070.	-	-	-	BBN2014660400070.	-	-	-
5	BBN2011660500070.	-	-	-	BBN2014660500070.	-	-	-
6	BBN2011660600070.	-	-	-	BBN2014660600070.	-	-	-
7	BBN2011660700070.	-	-	-	BBN2014660700070.	-	-	-
8	BBN2011660800070.	-	-	-				
9	BBN2011660900070.	-	-	-				
10	BBN2011661000070.	-	-	-				
11	BBN2011661100070.	-	-	-				
12	BBN2011661200070.	-	-	-				

H2120 mm

No. of bays	Item no. Freestanding bay	Melamine EUR	Painted EUR	Veneer EUR	Item no. Intermediate bay	Melamine EUR	Painted EUR	Veneer EUR
1	BBN2011760100070.	-	-	-	BBN2014760100070.	-	-	-
2	BBN2011760200070.	-	-	-	BBN2014760200070.	-	-	-
3	BBN2011760300070.	-	-	-	BBN2014760300070.	-	-	-
4	BBN2011760400070.	-	-	-	BBN2014760400070.	-	-	-
5	BBN2011760500070.	-	-	-	BBN2014760500070.	-	-	-
6	BBN2011760600070.	-	-	-	BBN2014760600070.	-	-	-
7	BBN2011760700070.	-	-	-	BBN2014760700070.	-	-	-
8	BBN2011760800070.	-	-	-				
9	BBN2011760900070.	-	-	-				
10	BBN2011761000070.	-	-	-				
11	BBN2011761100070.	-	-	-				
12	BBN2011761200070.	-	-	-				

LINGO ROUND SHELVING SYSTEM

BBN201 - 26° - LOW STEEL BACK PANEL - ADJUSTABLE FEET - FOR TOP SHELF



LINGO ROUND SHELVING SYSTEM

BBN201 - 26° - LOW STEEL BACK PANEL - ADJUSTABLE FEET - FOR TOP SHELF

Round shelving system with wooden panels and low steel back panel.
To be used with top shelves WT5 full depth and WT5 double-sided top shelf.
Freestanding bay includes 2 end wooden panels and 1 low steel back panel.
Intermediate bay includes 1 intermediate wooden panel and 1 low steel back panel.

- Prices based on steel price group 1 and wooden price group A (see Design Options pages 6-9).
- For top shelves, see from page 340
- For shelves, see from page 328
- For plinths, see page 349

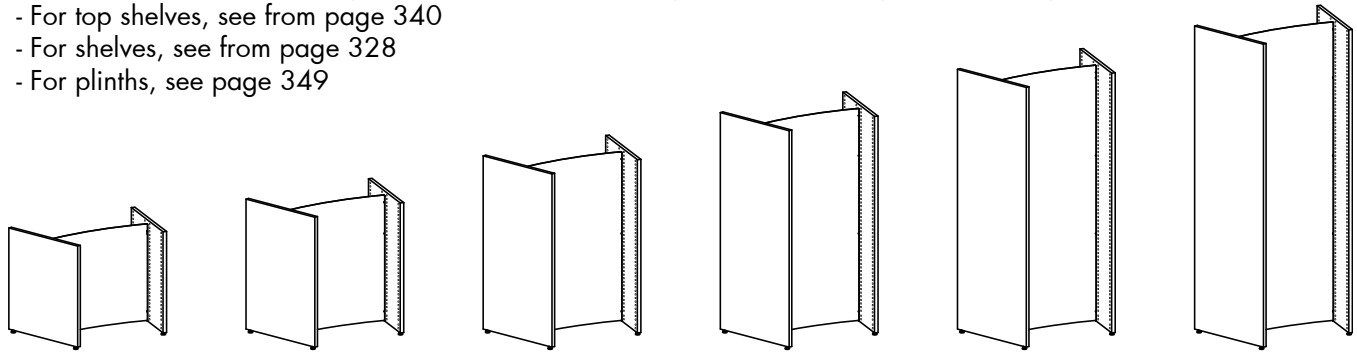

Double-sided freestanding bay - H720/920/1220/1520/1820/2120 mm

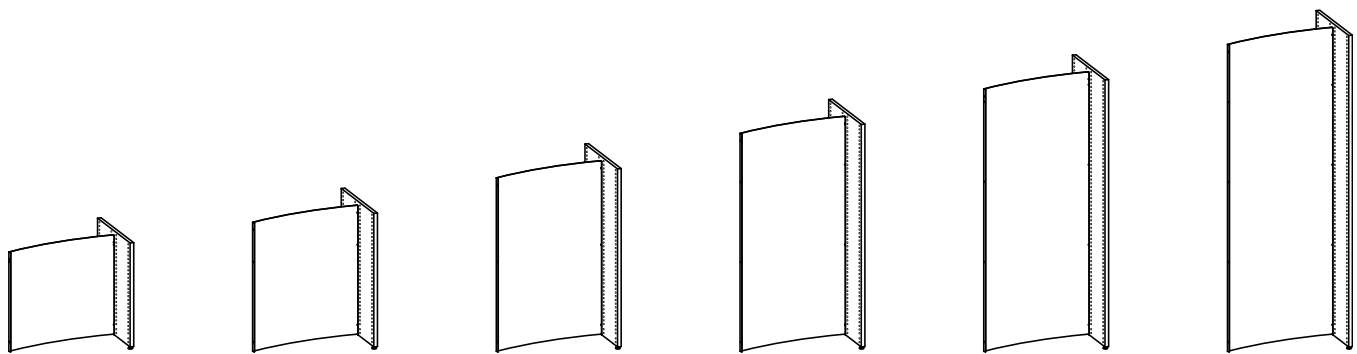

Double-sided intermediate bay - H720/920/1220/1520/1820/2120 mm

LINGO ROUND SHELVING SYSTEM

26° - LOW STEEL BACK PANEL - ADJUSTABLE FEET - FOR TOP SHELF

Painted and veneered Lingo Shelving Systems are FSC-certified.

H720 mm

No. of bays	Item no. Freestanding bay	Melamine EUR	Painted EUR	Veneer EUR	Item no. Intermediate bay	Melamine EUR	Painted EUR	Veneer EUR
1	BBN2011260100080.	-	-	-	BBN2014260100080.	-	-	-
2	BBN2011260200080.	-	-	-	BBN2014260200080.	-	-	-
3	BBN2011260300080.	-	-	-	BBN2014260300080.	-	-	-
4	BBN2011260400080.	-	-	-	BBN2014260400080.	-	-	-
5	BBN2011260500080.	-	-	-	BBN2014260500080.	-	-	-
6	BBN2011260600080.	-	-	-	BBN2014260600080.	-	-	-
7	BBN2011260700080.	-	-	-	BBN2014260700080.	-	-	-
8	BBN2011260800080.	-	-	-				
9	BBN2011260900080.	-	-	-				
10	BBN2011261000080.	-	-	-				
11	BBN2011261100080.	-	-	-				
12	BBN2011261200080.	-	-	-				

H920 mm

No. of bays	Item no. Freestanding bay	Melamine EUR	Painted EUR	Veneer EUR	Item no. Intermediate bay	Melamine EUR	Painted EUR	Veneer EUR
1	BBN2011360100080.	-	-	-	BBN2014360100080.	-	-	-
2	BBN2011360200080.	-	-	-	BBN2014360200080.	-	-	-
3	BBN2011360300080.	-	-	-	BBN2014360300080.	-	-	-
4	BBN2011360400080.	-	-	-	BBN2014360400080.	-	-	-
5	BBN2011360500080.	-	-	-	BBN2014360500080.	-	-	-
6	BBN2011360600080.	-	-	-	BBN2014360600080.	-	-	-
7	BBN2011360700080.	-	-	-	BBN2014360700080.	-	-	-
8	BBN2011360800080.	-	-	-				
9	BBN2011360900080.	-	-	-				
10	BBN2011361000080.	-	-	-				
11	BBN2011361100080.	-	-	-				
12	BBN2011361200080.	-	-	-				

H1220 mm

No. of bays	Item no. Freestanding bay	Melamine EUR	Painted EUR	Veneer EUR	Item no. Intermediate bay	Melamine EUR	Painted EUR	Veneer EUR
1	BBN2011460100080.	-	-	-	BBN2014460100080.	-	-	-
2	BBN2011460200080.	-	-	-	BBN2014460200080.	-	-	-
3	BBN2011460300080.	-	-	-	BBN2014460300080.	-	-	-
4	BBN2011460400080.	-	-	-	BBN2014460400080.	-	-	-
5	BBN2011460500080.	-	-	-	BBN2014460500080.	-	-	-
6	BBN2011460600080.	-	-	-	BBN2014460600080.	-	-	-
7	BBN2011460700080.	-	-	-	BBN2014460700080.	-	-	-
8	BBN2011460800080.	-	-	-				
9	BBN2011460900080.	-	-	-				
10	BBN2011461000080.	-	-	-				
11	BBN2011461100080.	-	-	-				
12	BBN2011461200080.	-	-	-				

LINGO ROUND SHELVING SYSTEM

26° - LOW STEEL BACK PANEL - ADJUSTABLE FEET - FOR TOP SHELF

Painted and veneered Lingo Shelving Systems are FSC-certified.

H1520 mm

No. of bays	Item no. Freestanding bay	Melamine EUR	Painted EUR	Veneer EUR	Item no. Intermediate bay	Melamine EUR	Painted EUR	Veneer EUR
1	BBN2011560100080.	-	-	-	BBN2014560100080.	-	-	-
2	BBN2011560200080.	-	-	-	BBN2014560200080.	-	-	-
3	BBN2011560300080.	-	-	-	BBN2014560300080.	-	-	-
4	BBN2011560400080.	-	-	-	BBN2014560400080.	-	-	-
5	BBN2011560500080.	-	-	-	BBN2014560500080.	-	-	-
6	BBN2011560600080.	-	-	-	BBN2014560600080.	-	-	-
7	BBN2011560700080.	-	-	-	BBN2014560700080.	-	-	-
8	BBN2011560800080.	-	-	-				
9	BBN2011560900080.	-	-	-				
10	BBN2011561000080.	-	-	-				
11	BBN2011561100080.	-	-	-				
12	BBN2011561200080.	-	-	-				

H1820 mm

No. of bays	Item no. Freestanding bay	Melamine EUR	Painted EUR	Veneer EUR	Item no. Intermediate bay	Melamine EUR	Painted EUR	Veneer EUR
1	BBN2011660100080.	-	-	-	BBN2014660100080.	-	-	-
2	BBN2011660200080.	-	-	-	BBN2014660200080.	-	-	-
3	BBN2011660300080.	-	-	-	BBN2014660300080.	-	-	-
4	BBN2011660400080.	-	-	-	BBN2014660400080.	-	-	-
5	BBN2011660500080.	-	-	-	BBN2014660500080.	-	-	-
6	BBN2011660600080.	-	-	-	BBN2014660600080.	-	-	-
7	BBN2011660700080.	-	-	-	BBN2014660700080.	-	-	-
8	BBN2011660800080.	-	-	-				
9	BBN2011660900080.	-	-	-				
10	BBN2011661000080.	-	-	-				
11	BBN2011661100080.	-	-	-				
12	BBN2011661200080.	-	-	-				

H2120 mm

No. of bays	Item no. Freestanding bay	Melamine EUR	Painted EUR	Veneer EUR	Item no. Intermediate bay	Melamine EUR	Painted EUR	Veneer EUR
1	BBN2011760100080.	-	-	-	BBN2014760100080.	-	-	-
2	BBN2011760200080.	-	-	-	BBN2014760200080.	-	-	-
3	BBN2011760300080.	-	-	-	BBN2014760300080.	-	-	-
4	BBN2011760400080.	-	-	-	BBN2014760400080.	-	-	-
5	BBN2011760500080.	-	-	-	BBN2014760500080.	-	-	-
6	BBN2011760600080.	-	-	-	BBN2014760600080.	-	-	-
7	BBN2011760700080.	-	-	-	BBN2014760700080.	-	-	-
8	BBN2011760800080.	-	-	-				
9	BBN2011760900080.	-	-	-				
10	BBN2011761000080.	-	-	-				
11	BBN2011761100080.	-	-	-				
12	BBN2011761200080.	-	-	-				

LINGO ROUND SHELVING SYSTEM

BBN202 - 26° - STEEL BACK FRAME - ADJUSTABLE FEET - WITH TOP PLATE



LINGO ROUND SHELVING SYSTEM

BBN202 - 26° - STEEL BACK FRAME - ADJUSTABLE FEET - WITH TOP PLATE

Round shelving system with wooden end panels, intermediate panels, steel back frame and overlaying top plate.
See further description on starter, intermediate and end sections on pages 26-27.

- Prices based on steel price group 1 and wooden price group A (see Design Options pages 6-9).
- For shelves, see from page 328
- For end panel bays, see page 378
- For plinths, see page 349

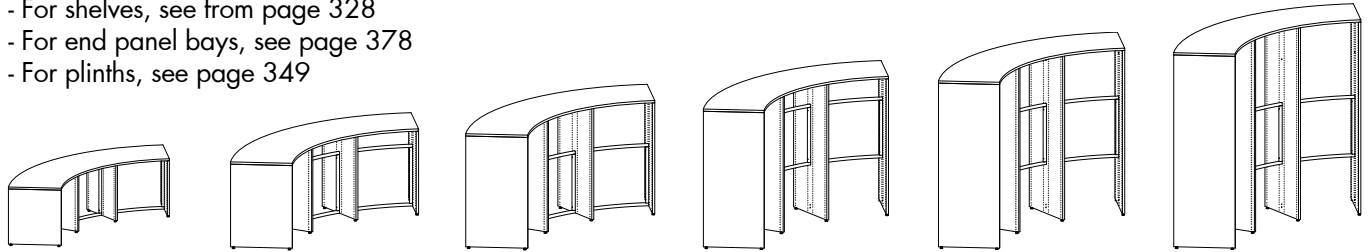

Freestanding 26° double-sided bays - H720/920/1220/1520/1820/2120 mm

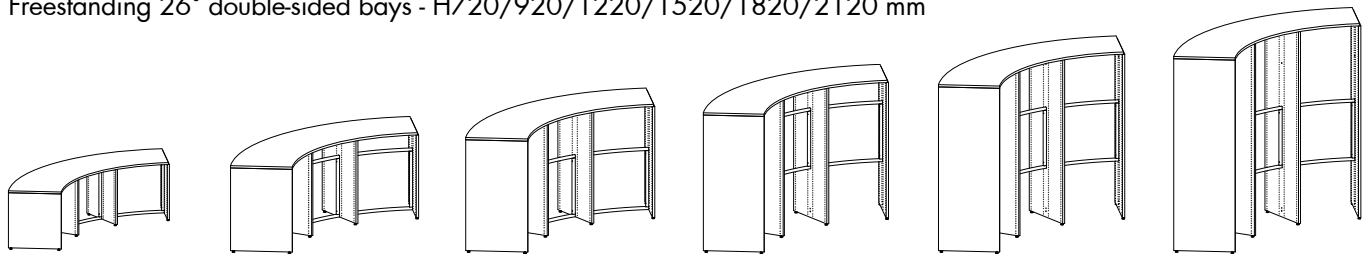

Left starter 26° double-sided bays - H720/920/1220/1520/1820/2120 mm

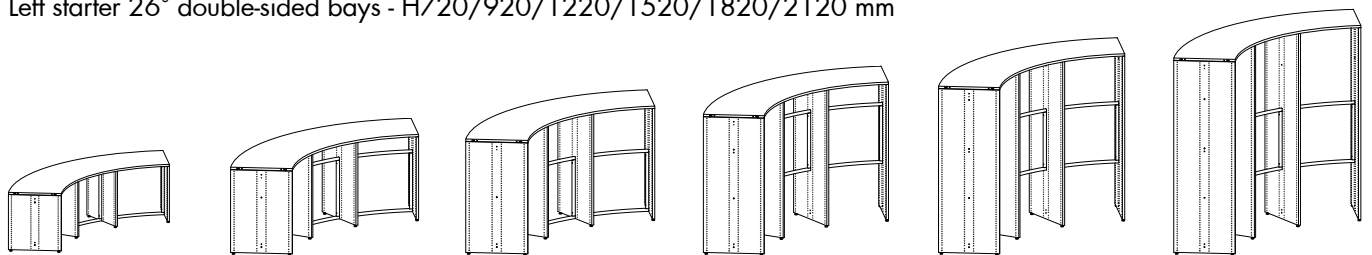

Right starter 26° double-sided bays - H720/920/1220/1520/1820/2120 mm

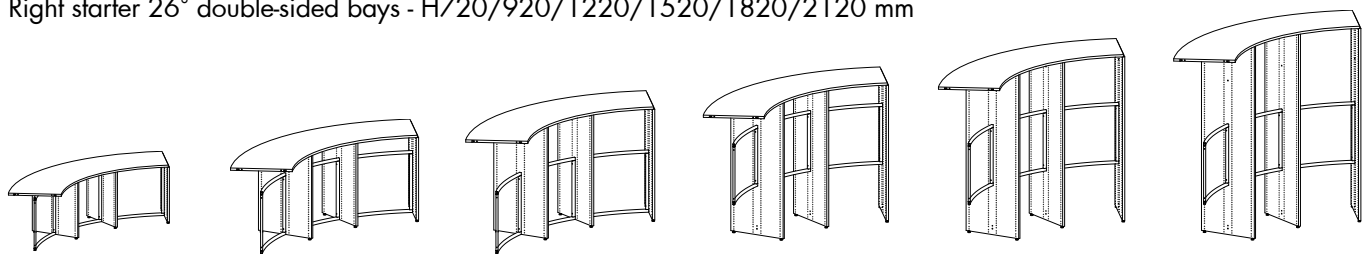

Intermediate 26° double-sided bays - H720/920/1220/1520/1820/2120 mm

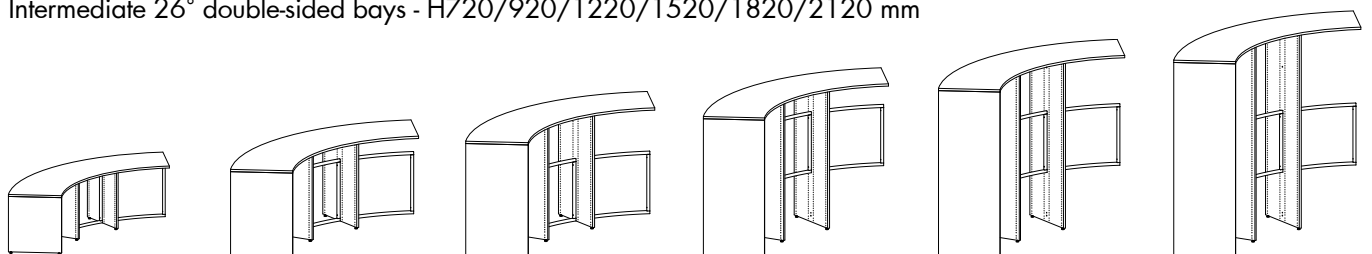

Left end 26° double-sided bays - H720/920/1220/1520/1820/2120 mm

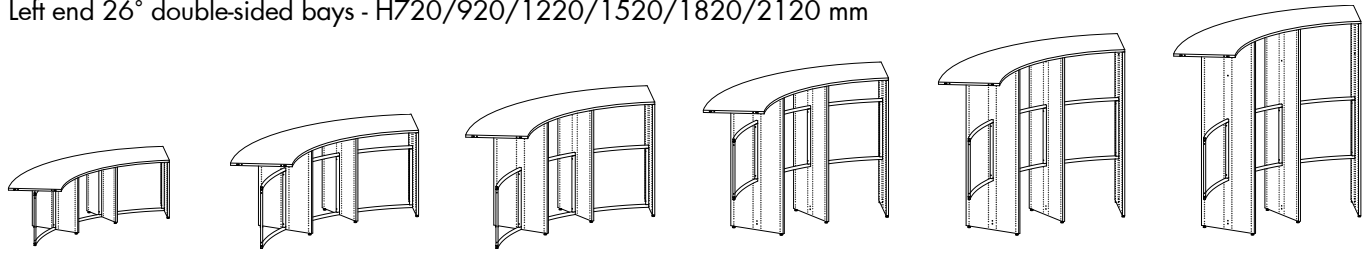

Right end 26° double-sided bays - H720/920/1220/1520/1820/2120 mm

LINGO ROUND SHELVING SYSTEM

26° - STEEL BACK FRAME - ADJUSTABLE FEET - WITH TOP PLATE - FREESTANDING SECTION

Painted and veneered Lingo Shelving Systems are FSC-certified.

H720 mm

No. of bays	Item no.	Melamine EUR	Painted EUR	Veneer EUR
1	BBN2021260110060.	-	-	-
2	BBN2021260210060.	-	-	-
3	BBN2021260310060.	-	-	-

H920 mm

No. of bays	Item no.	Melamine EUR	Painted EUR	Veneer EUR
1	BBN2021360110060.	-	-	-
2	BBN2021360210060.	-	-	-
3	BBN2021360310060.	-	-	-

H1220 mm

No. of bays	Item no.	Melamine EUR	Painted EUR	Veneer EUR
1	BBN2021460110060.	-	-	-
2	BBN2021460210060.	-	-	-
3	BBN2021460310060.	-	-	-

H1520 mm

No. of bays	Item no.	Melamine EUR	Painted EUR	Veneer EUR
1	BBN2021560110060.	-	-	-
2	BBN2021560210060.	-	-	-
3	BBN2021560310060.	-	-	-

H1820 mm

No. of bays	Item no.	Melamine EUR	Painted EUR	Veneer EUR
1	BBN2021660110060.	-	-	-
2	BBN2021660210060.	-	-	-
3	BBN2021660310060.	-	-	-

H2120 mm

No. of bays	Item no.	Melamine EUR	Painted EUR	Veneer EUR
1	BBN2021760110060.	-	-	-
2	BBN2021760210060.	-	-	-
3	BBN2021760310060.	-	-	-

LINGO ROUND SHELVING SYSTEM

26° - STEEL BACK FRAME - ADJUSTABLE FEET - WITH TOP PLATE - LEFT STARTER SECTION

Painted and veneered Lingo Shelving Systems are FSC-certified.

H720 mm

No. of bays	Item no.	Melamine EUR	Painted EUR	Veneer EUR
1	BBN2022260110060.	-	-	-
2	BBN2022260210060.	-	-	-
3	BBN2022260310060.	-	-	-

H920 mm

No. of bays	Item no.	Melamine EUR	Painted EUR	Veneer EUR
1	BBN2022360110060.	-	-	-
2	BBN2022360210060.	-	-	-
3	BBN2022360310060.	-	-	-

H1220 mm

No. of bays	Item no.	Melamine EUR	Painted EUR	Veneer EUR
1	BBN2022460110060.	-	-	-
2	BBN2022460210060.	-	-	-
3	BBN2022460310060.	-	-	-

H1520 mm

No. of bays	Item no.	Melamine EUR	Painted EUR	Veneer EUR
1	BBN2022560110060.	-	-	-
2	BBN2022560210060.	-	-	-
3	BBN2022560310060.	-	-	-

H1820 mm

No. of bays	Item no.	Melamine EUR	Painted EUR	Veneer EUR
1	BBN2022660110060.	-	-	-
2	BBN2022660210060.	-	-	-
3	BBN2022660310060.	-	-	-

H2120 mm

No. of bays	Item no.	Melamine EUR	Painted EUR	Veneer EUR
1	BBN2022760110060.	-	-	-
2	BBN2022760210060.	-	-	-
3	BBN2022760310060.	-	-	-

LINGO ROUND SHELVING SYSTEM

26° - STEEL BACK FRAME - ADJUSTABLE FEET - WITH TOP PLATE - RIGHT STARTER SECTION

Painted and veneered Lingo Shelving Systems are FSC-certified.

H720 mm

No. of bays	Item no.	Melamine EUR	Painted EUR	Veneer EUR
1	BBN2023260110060.	-	-	-
2	BBN2023260210060.	-	-	-
3	BBN2023260310060.	-	-	-

H920 mm

No. of bays	Item no.	Melamine EUR	Painted EUR	Veneer EUR
1	BBN2023360110060.	-	-	-
2	BBN2023360210060.	-	-	-
3	BBN2023360310060.	-	-	-

H1220 mm

No. of bays	Item no.	Melamine EUR	Painted EUR	Veneer EUR
1	BBN2023460110060.	-	-	-
2	BBN2023460210060.	-	-	-
3	BBN2023460310060.	-	-	-

H1520 mm

No. of bays	Item no.	Melamine EUR	Painted EUR	Veneer EUR
1	BBN2023560110060.	-	-	-
2	BBN2023560210060.	-	-	-
3	BBN2023560310060.	-	-	-

H1820 mm

No. of bays	Item no.	Melamine EUR	Painted EUR	Veneer EUR
1	BBN2023660110060.	-	-	-
2	BBN2023660210060.	-	-	-
3	BBN2023660310060.	-	-	-

H2120 mm

No. of bays	Item no.	Melamine EUR	Painted EUR	Veneer EUR
1	BBN2023760110060.	-	-	-
2	BBN2023760210060.	-	-	-
3	BBN2023760310060.	-	-	-

LINGO ROUND SHELVING SYSTEM

26° - STEEL BACK FRAME - ADJUSTABLE FEET - WITH TOP PLATE - INTERMEDIATE SECTION

Painted and veneered Lingo Shelving Systems are FSC-certified.

H720 mm

No. of bays	Item no.	Melamine EUR	Painted EUR	Veneer EUR
1	BBN2024260110060.	-	-	-
2	BBN2024260210060.	-	-	-
3	BBN2024260310060.	-	-	-

H920 mm

No. of bays	Item no.	Melamine EUR	Painted EUR	Veneer EUR
1	BBN2024360110060.	-	-	-
2	BBN2024360210060.	-	-	-
3	BBN2024360310060.	-	-	-

H1220 mm

No. of bays	Item no.	Melamine EUR	Painted EUR	Veneer EUR
1	BBN2024460110060.	-	-	-
2	BBN2024460210060.	-	-	-
3	BBN2024460310060.	-	-	-

H1520 mm

No. of bays	Item no.	Melamine EUR	Painted EUR	Veneer EUR
1	BBN2024560110060.	-	-	-
2	BBN2024560210060.	-	-	-
3	BBN2024560310060.	-	-	-

H1820 mm

No. of bays	Item no.	Melamine EUR	Painted EUR	Veneer EUR
1	BBN2024660110060.	-	-	-
2	BBN2024660210060.	-	-	-
3	BBN2024660310060.	-	-	-

H2120 mm

No. of bays	Item no.	Melamine EUR	Painted EUR	Veneer EUR
1	BBN2024760110060.	-	-	-
2	BBN2024760210060.	-	-	-
3	BBN2024760310060.	-	-	-

LINGO ROUND SHELVING SYSTEM

26° - STEEL BACK FRAME - ADJUSTABLE FEET - WITH TOP PLATE - LEFT END SECTION

Painted and veneered Lingo Shelving Systems are FSC-certified.

H720 mm

No. of bays	Item no.	Melamine EUR	Painted EUR	Veneer EUR
1	BBN2025260110060.	-	-	-
2	BBN2025260210060.	-	-	-
3	BBN2025260310060.	-	-	-

H920 mm

No. of bays	Item no.	Melamine EUR	Painted EUR	Veneer EUR
1	BBN2025360110060.	-	-	-
2	BBN2025360210060.	-	-	-
3	BBN2025360310060.	-	-	-

H1220 mm

No. of bays	Item no.	Melamine EUR	Painted EUR	Veneer EUR
1	BBN2025460110060.	-	-	-
2	BBN2025460210060.	-	-	-
3	BBN2025460310060.	-	-	-

H1520 mm

No. of bays	Item no.	Melamine EUR	Painted EUR	Veneer EUR
1	BBN2025560110060.	-	-	-
2	BBN2025560210060.	-	-	-
3	BBN2025560310060.	-	-	-

H1820 mm

No. of bays	Item no.	Melamine EUR	Painted EUR	Veneer EUR
1	BBN2025660110060.	-	-	-
2	BBN2025660210060.	-	-	-
3	BBN2025660310060.	-	-	-

H2120 mm

No. of bays	Item no.	Melamine EUR	Painted EUR	Veneer EUR
1	BBN2025760110060.	-	-	-
2	BBN2025760210060.	-	-	-
3	BBN2025760310060.	-	-	-

LINGO ROUND SHELVING SYSTEM

26° - STEEL BACK FRAME - ADJUSTABLE FEET - WITH TOP PLATE - RIGHT END SECTION

Painted and veneered Lingo Shelving Systems are FSC-certified.

H720 mm

No. of bays	Item no.	Melamine EUR	Painted EUR	Veneer EUR
1	BBN2026260110060.	-	-	-
2	BBN2026260210060.	-	-	-
3	BBN2026260310060.	-	-	-

H920 mm

No. of bays	Item no.	Melamine EUR	Painted EUR	Veneer EUR
1	BBN2026360110060.	-	-	-
2	BBN2026360210060.	-	-	-
3	BBN2026360310060.	-	-	-

H1220 mm

No. of bays	Item no.	Melamine EUR	Painted EUR	Veneer EUR
1	BBN2026460110060.	-	-	-
2	BBN2026460210060.	-	-	-
3	BBN2026460310060.	-	-	-

H1520 mm

No. of bays	Item no.	Melamine EUR	Painted EUR	Veneer EUR
1	BBN2026560110060.	-	-	-
2	BBN2026560210060.	-	-	-
3	BBN2026560310060.	-	-	-

H1820 mm

No. of bays	Item no.	Melamine EUR	Painted EUR	Veneer EUR
1	BBN2026660110060.	-	-	-
2	BBN2026660210060.	-	-	-
3	BBN2026660310060.	-	-	-

H2120 mm

No. of bays	Item no.	Melamine EUR	Painted EUR	Veneer EUR
1	BBN2026760110060.	-	-	-
2	BBN2026760210060.	-	-	-
3	BBN2026760310060.	-	-	-

LINGO ROUND SHELVING SYSTEM

BBN202 - 26° - STEEL BACK PANEL - ADJUSTABLE FEET - WITH TOP PLATE



LINGO ROUND SHELVING SYSTEM

BBN202 - 26° - STEEL BACK PANEL - ADJUSTABLE FEET - WITH TOP PLATE

Round shelving system with wooden end panels, intermediate panels, steel back panel and overlaying top plate.
See further description on starter, intermediate and end sections on pages 26-27.

- Prices based on steel price group 1 and wooden price group A (see Design Options pages 6-9).
- For shelves, see from page 328
- For castor frame, see page 347

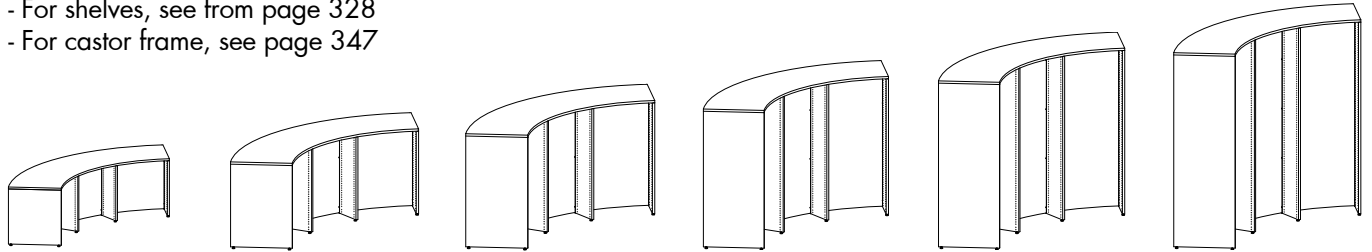

Freestanding 26° double-sided bays - H720/920/1220/1520/1820/2120 mm

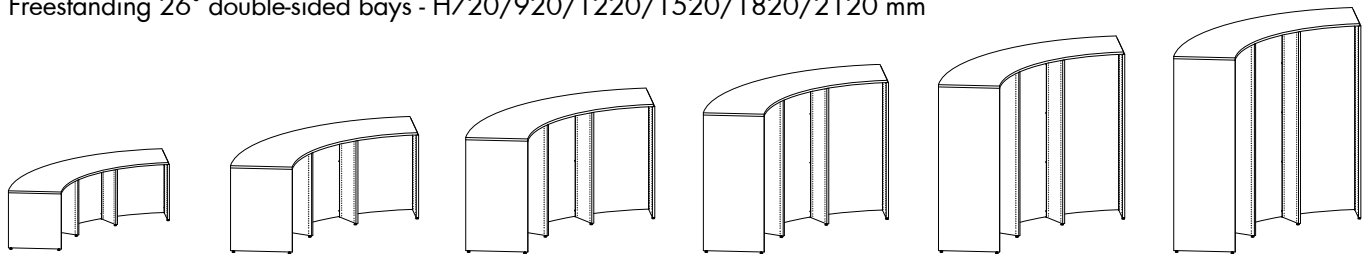

Left starter 26° double-sided bays - H720/920/1220/1520/1820/2120 mm

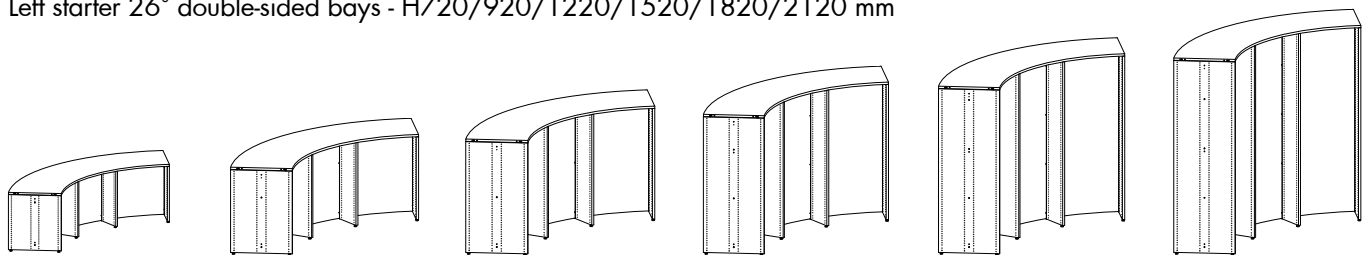

Right starter 26° double-sided bays - H720/920/1220/1520/1820/2120 mm

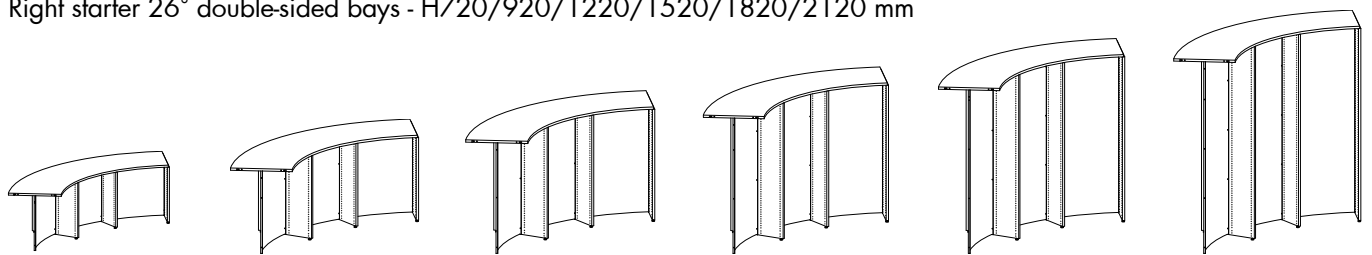

Intermediate 18° double-sided bays - H720/920/1220/1520/1820/2120 mm

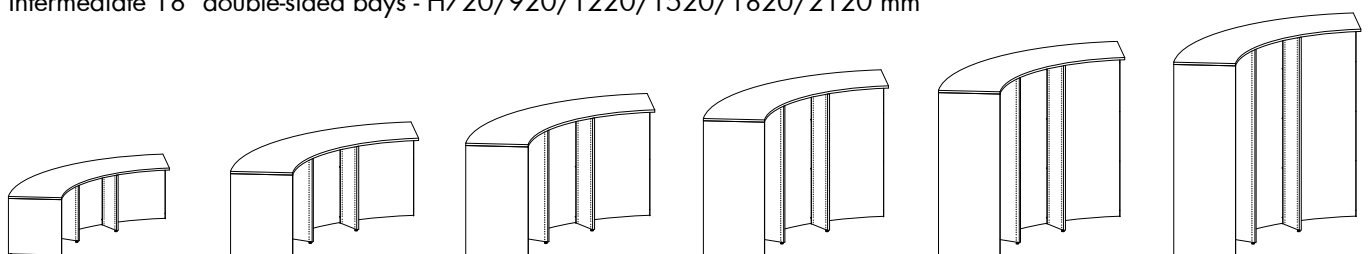

Left end 26° double-sided bays - H720/920/1220/1520/1820/2120 mm

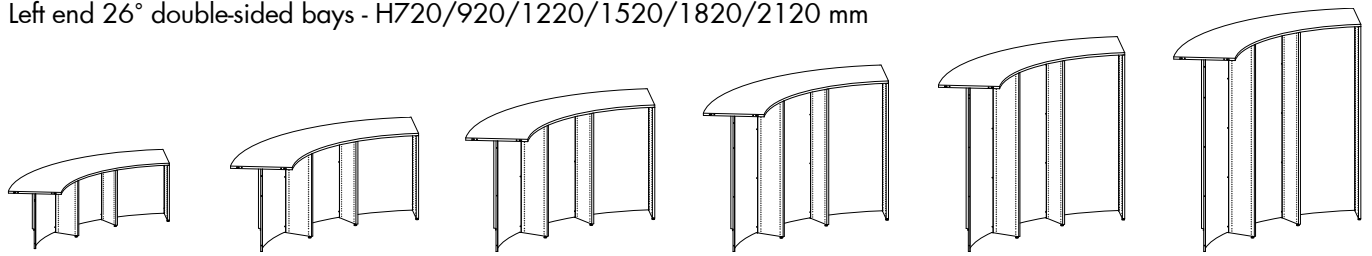

Right end 26° double-sided bays - H720/920/1220/1520/1820/2120 mm

LINGO ROUND SHELVING SYSTEM

26° - STEEL BACK PANEL - ADJUSTABLE FEET - WITH TOP PLATE - FREESTANDING SECTION

Painted and veneered Lingo Shelving Systems are FSC-certified.

H720 mm

No. of bays	Item no.	Melamine EUR	Painted EUR	Veneer EUR
1	BBN2021260110080.	-	-	-
2	BBN2021260210080.	-	-	-
3	BBN2021260310080.	-	-	-

H920 mm

No. of bays	Item no.	Melamine EUR	Painted EUR	Veneer EUR
1	BBN2021360110080.	-	-	-
2	BBN2021360210080.	-	-	-
3	BBN2021360310080.	-	-	-

H1220 mm

No. of bays	Item no.	Melamine EUR	Painted EUR	Veneer EUR
1	BBN2021460110080.	-	-	-
2	BBN2021460210080.	-	-	-
3	BBN2021460310080.	-	-	-

H1520 mm

No. of bays	Item no.	Melamine EUR	Painted EUR	Veneer EUR
1	BBN2021560110080.	-	-	-
2	BBN2021560210080.	-	-	-
3	BBN2021560310080.	-	-	-

H1820 mm

No. of bays	Item no.	Melamine EUR	Painted EUR	Veneer EUR
1	BBN2021660110080.	-	-	-
2	BBN2021660210080.	-	-	-
3	BBN2021660310080.	-	-	-

H2120 mm

No. of bays	Item no.	Melamine EUR	Painted EUR	Veneer EUR
1	BBN2021760110080.	-	-	-
2	BBN2021760210080.	-	-	-
3	BBN2021760310080.	-	-	-

LINGO ROUND SHELVING SYSTEM

26° - STEEL BACK PANEL - ADJUSTABLE FEET - WITH TOP PLATE - LEFT STARTER SECTION

Painted and veneered Lingo Shelving Systems are FSC-certified.

H720 mm

No. of bays	Item no.	Melamine EUR	Painted EUR	Veneer EUR
1	BBN2022260110080.	-	-	-
2	BBN2022260210080.	-	-	-
3	BBN2022260310080.	-	-	-

H920 mm

No. of bays	Item no.	Melamine EUR	Painted EUR	Veneer EUR
1	BBN2022360110080.	-	-	-
2	BBN2022360210080.	-	-	-
3	BBN2022360310080.	-	-	-

H1220 mm

No. of bays	Item no.	Melamine EUR	Painted EUR	Veneer EUR
1	BBN2022460110080.	-	-	-
2	BBN2022460210080.	-	-	-
3	BBN2022460310080.	-	-	-

H1520 mm

No. of bays	Item no.	Melamine EUR	Painted EUR	Veneer EUR
1	BBN2022560110080.	-	-	-
2	BBN2022560210080.	-	-	-
3	BBN2022560310080.	-	-	-

H1820 mm

No. of bays	Item no.	Melamine EUR	Painted EUR	Veneer EUR
1	BBN2022660110080.	-	-	-
2	BBN2022660210080.	-	-	-
3	BBN2022660310080.	-	-	-

H2120 mm

No. of bays	Item no.	Melamine EUR	Painted EUR	Veneer EUR
1	BBN2022760110080.	-	-	-
2	BBN2022760210080.	-	-	-
3	BBN2022760310080.	-	-	-

LINGO ROUND SHELVING SYSTEM

26° - STEEL BACK PANEL - ADJUSTABLE FEET - WITH TOP PLATE - RIGHT STARTER SECTION

Painted and veneered Lingo Shelving Systems are FSC-certified.

H720 mm

No. of bays	Item no.	Melamine EUR	Painted EUR	Veneer EUR
1	BBN2023260110080.	-	-	-
2	BBN2023260210080.	-	-	-
3	BBN2023260310080.	-	-	-

H920 mm

No. of bays	Item no.	Melamine EUR	Painted EUR	Veneer EUR
1	BBN2023360110080.	-	-	-
2	BBN2023360210080.	-	-	-
3	BBN2023360310080.	-	-	-

H1220 mm

No. of bays	Item no.	Melamine EUR	Painted EUR	Veneer EUR
1	BBN2023460110080.	-	-	-
2	BBN2023460210080.	-	-	-
3	BBN2023460310080.	-	-	-

H1520 mm

No. of bays	Item no.	Melamine EUR	Painted EUR	Veneer EUR
1	BBN2023560110080.	-	-	-
2	BBN2023560210080.	-	-	-
3	BBN2023560310080.	-	-	-

H1820 mm

No. of bays	Item no.	Melamine EUR	Painted EUR	Veneer EUR
1	BBN2023660110080.	-	-	-
2	BBN2023660210080.	-	-	-
3	BBN2023660310080.	-	-	-

H2120 mm

No. of bays	Item no.	Melamine EUR	Painted EUR	Veneer EUR
1	BBN2023760110080.	-	-	-
2	BBN2023760210080.	-	-	-
3	BBN2023760310080.	-	-	-

LINGO ROUND SHELVING SYSTEM

26° - STEEL BACK PANEL - ADJUSTABLE FEET - WITH TOP PLATE - INTERMEDIATE SECTION

Painted and veneered Lingo Shelving Systems are FSC-certified.

H720 mm

No. of bays	Item no.	Melamine EUR	Painted EUR	Veneer EUR
1	BBN2024260110080.	-	-	-
2	BBN2024260210080.	-	-	-
3	BBN2024260310080.	-	-	-

H920 mm

No. of bays	Item no.	Melamine EUR	Painted EUR	Veneer EUR
1	BBN2024360110080.	-	-	-
2	BBN2024360210080.	-	-	-
3	BBN2024360310080.	-	-	-

H1220 mm

No. of bays	Item no.	Melamine EUR	Painted EUR	Veneer EUR
1	BBN2024460110080.	-	-	-
2	BBN2024460210080.	-	-	-
3	BBN2024460310080.	-	-	-

H1520 mm

No. of bays	Item no.	Melamine EUR	Painted EUR	Veneer EUR
1	BBN2024560110080.	-	-	-
2	BBN2024560210080.	-	-	-
3	BBN2024560310080.	-	-	-

H1820 mm

No. of bays	Item no.	Melamine EUR	Painted EUR	Veneer EUR
1	BBN2024660110080.	-	-	-
2	BBN2024660210080.	-	-	-
3	BBN2024660310080.	-	-	-

H2120 mm

No. of bays	Item no.	Melamine EUR	Painted EUR	Veneer EUR
1	BBN2024760110080.	-	-	-
2	BBN2024760210080.	-	-	-
3	BBN2024760310080.	-	-	-

LINGO ROUND SHELVING SYSTEM

26° - STEEL BACK PANEL - ADJUSTABLE FEET - WITH TOP PLATE - LEFT END SECTION

Painted and veneered Lingo Shelving Systems are FSC-certified.

H720 mm

No. of bays	Item no.	Melamine EUR	Painted EUR	Veneer EUR
1	BBN2025260110080.	-	-	-
2	BBN2025260210080.	-	-	-
3	BBN2025260310080.	-	-	-

H920 mm

No. of bays	Item no.	Melamine EUR	Painted EUR	Veneer EUR
1	BBN2025360110080.	-	-	-
2	BBN2025360210080.	-	-	-
3	BBN2025360310080.	-	-	-

H1220 mm

No. of bays	Item no.	Melamine EUR	Painted EUR	Veneer EUR
1	BBN2025460110080.	-	-	-
2	BBN2025460210080.	-	-	-
3	BBN2025460310080.	-	-	-

H1520 mm

No. of bays	Item no.	Melamine EUR	Painted EUR	Veneer EUR
1	BBN2025560110080.	-	-	-
2	BBN2025560210080.	-	-	-
3	BBN2025560310080.	-	-	-

H1820 mm

No. of bays	Item no.	Melamine EUR	Painted EUR	Veneer EUR
1	BBN2025660110080.	-	-	-
2	BBN2025660210080.	-	-	-
3	BBN2025660310080.	-	-	-

H2120 mm

No. of bays	Item no.	Melamine EUR	Painted EUR	Veneer EUR
1	BBN2025760110080.	-	-	-
2	BBN2025760210080.	-	-	-
3	BBN2025760310080.	-	-	-

LINGO ROUND SHELVING SYSTEM

26° - STEEL BACK PANEL - ADJUSTABLE FEET - WITH TOP PLATE - RIGHT END SECTION

Painted and veneered Lingo Shelving Systems are FSC-certified.

H720 mm

No. of bays	Item no.	Melamine EUR	Painted EUR	Veneer EUR
1	BBN2026260110080.	-	-	-
2	BBN2026260210080.	-	-	-
3	BBN2026260310080.	-	-	-

H920 mm

No. of bays	Item no.	Melamine EUR	Painted EUR	Veneer EUR
1	BBN2026360110080.	-	-	-
2	BBN2026360210080.	-	-	-
3	BBN2026360310080.	-	-	-

H1220 mm

No. of bays	Item no.	Melamine EUR	Painted EUR	Veneer EUR
1	BBN2026460110080.	-	-	-
2	BBN2026460210080.	-	-	-
3	BBN2026460310080.	-	-	-

H1520 mm

No. of bays	Item no.	Melamine EUR	Painted EUR	Veneer EUR
1	BBN2026560110080.	-	-	-
2	BBN2026560210080.	-	-	-
3	BBN2026560310080.	-	-	-

H1820 mm

No. of bays	Item no.	Melamine EUR	Painted EUR	Veneer EUR
1	BBN2026660110080.	-	-	-
2	BBN2026660210080.	-	-	-
3	BBN2026660310080.	-	-	-

H2120 mm

No. of bays	Item no.	Melamine EUR	Painted EUR	Veneer EUR
1	BBN2026760110080.	-	-	-
2	BBN2026760210080.	-	-	-
3	BBN2026760310080.	-	-	-

LINGO ROUND SHELVING SYSTEM

BBN211 - 26° - STEEL BACK FRAME - CASTOR PLATE - FOR TOP SHELF



LINGO ROUND SHELVING SYSTEM

BBN211 - 26° - STEEL BACK FRAME - CASTOR PLATE - FOR TOP SHELF

Round shelving system with wooden panels, steel back frame and castor plate. To be used with top shelf.

- Prices based on steel price group 1 and wooden price group A (see Design Options pages 6-9).
- For top shelves, see from page 340
- For shelves, see from page 328

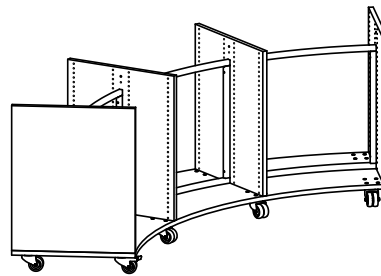
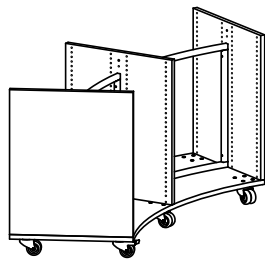
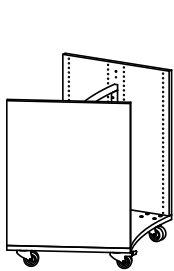

Double-sided H920 mm - 1/2/3 bays

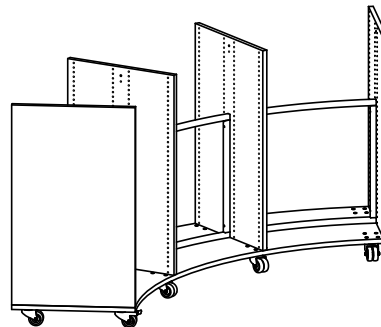
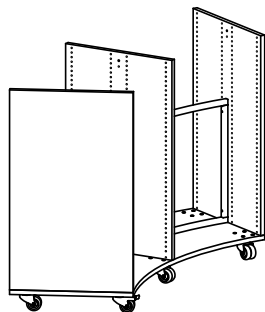
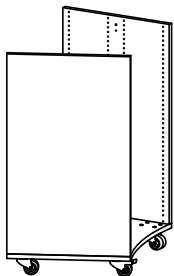

Double-sided H1220 mm - 1/2/3 bays

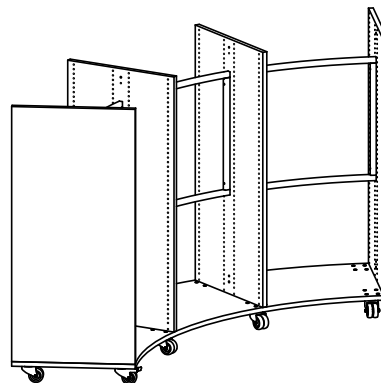
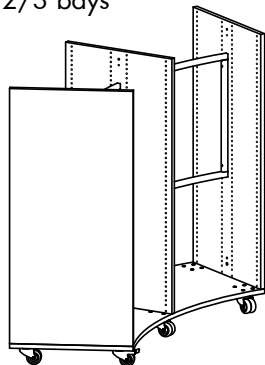
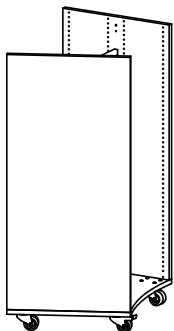

Double-sided H1520 mm - 1/2/3 bays

LINGO ROUND SHELVING SYSTEM

26° - STEEL BACK FRAME - CASTOR PLATE - FOR TOP SHELF

Painted and veneered Lingo Shelving Systems are FSC-certified.

H920 mm

No. of bays	Item no.	Melamine EUR	Painted EUR	Veneer EUR
1	BBN211136010006.	-	-	-
2	BBN211136020006.	-	-	-
3	BBN211136030006.	-	-	-

H1220 mm

No. of bays	Item no.	Melamine EUR	Painted EUR	Veneer EUR
1	BBN211146010006.	-	-	-
2	BBN211146020006.	-	-	-
3	BBN211146030006.	-	-	-

H1520 mm

No. of bays	Item no.	Melamine EUR	Painted EUR	Veneer EUR
1	BBN211156010006.	-	-	-
2	BBN211156020006.	-	-	-
3	BBN211156030006.	-	-	-

LINGO ROUND SHELVING SYSTEM

26° - STEEL BACK FRAME - CASTOR PLATE - FOR TOP SHELF

LINGO ROUND SHELVING SYSTEM

BBN211 - 26° - HIGH STEEL BACK PANEL - CASTOR PLATE - FOR TOP SHELF



LINGO ROUND SHELVING SYSTEM

BBN211 - 26° - HIGH STEEL BACK PANEL - CASTOR PLATE - FOR TOP SHELF

Round shelving system with wooden panels, high steel back panel and castor plate.
To be used with top shelves WT5 standard depth top shelf.

- Prices based on steel price group 1 and wooden price group A (see Design Options pages 6-9).
- For top shelves, see from page 340
- For shelves, see from page 328

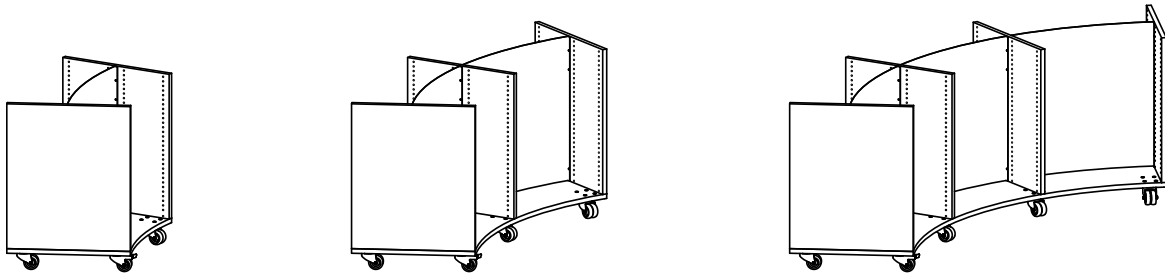

Double-sided H920 mm - 1/2/3 bays

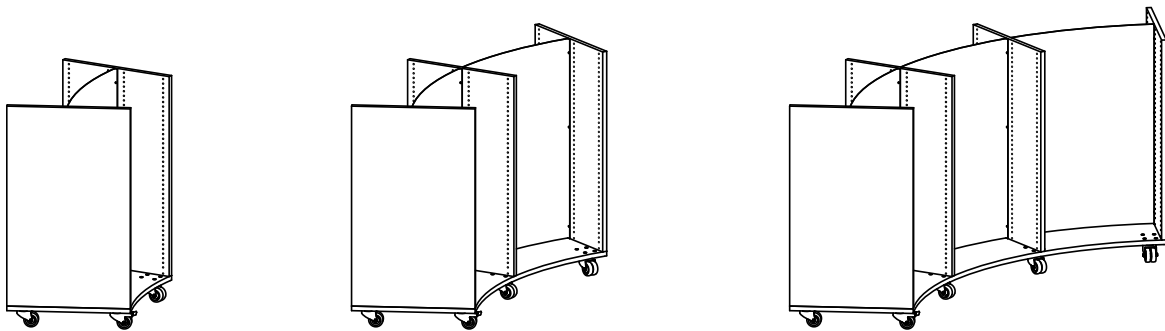

Double-sided H1220 mm - 1/2/3 bays

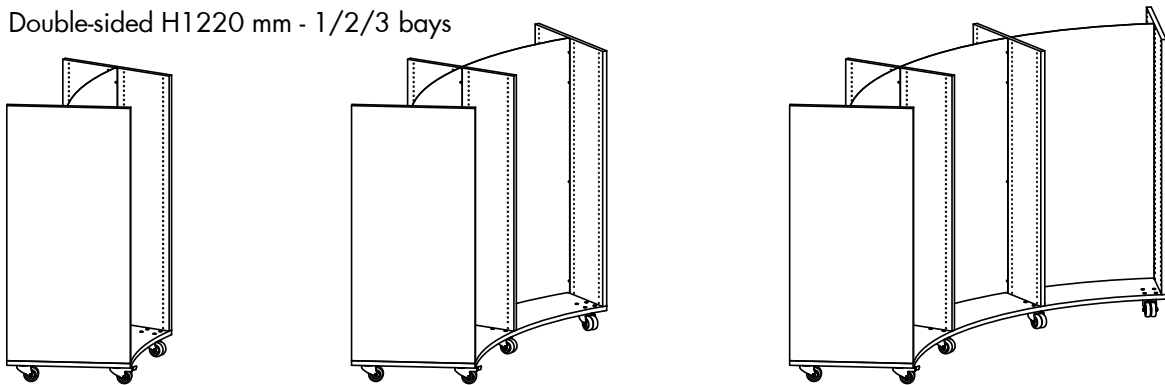

Double-sided H1520 mm - 1/2/3 bays

LINGO ROUND SHELVING SYSTEM

26° - HIGH STEEL BACK PANEL - CASTOR PLATE - FOR TOP SHELF

Painted and veneered Lingo Shelving Systems are FSC-certified.

H920 mm

No. of bays	Item no.	Melamine EUR	Painted EUR	Veneer EUR
1	BBN211136010008.	-	-	-
2	BBN211136020008.	-	-	-
3	BBN211136030008.	-	-	-

H1220 mm

No. of bays	Item no.	Melamine EUR	Painted EUR	Veneer EUR
1	BBN211146010008.	-	-	-
2	BBN211146020008.	-	-	-
3	BBN211146030008.	-	-	-

H1520 mm

No. of bays	Item no.	Melamine EUR	Painted EUR	Veneer EUR
1	BBN211156010008.	-	-	-
2	BBN211156020008.	-	-	-
3	BBN211156030008.	-	-	-

LINGO ROUND SHELVING SYSTEM

26° - HIGH STEEL BACK PANEL - CASTOR PLATE - FOR TOP SHELF

LINGO ROUND SHELVING SYSTEM

BBN211 - 26° - LOW STEEL BACK PANEL - CASTOR PLATE - FOR TOP SHELF



LINGO ROUND SHELVING SYSTEM

BBN211 - 26° - LOW STEEL BACK PANEL - CASTOR PLATE - FOR TOP SHELF

Round shelving system with wooden panels, low steel back panel and castor plate.
To be used with top shelves WT5 full depth and WT5 double-sided top shelf.

- Prices based on steel price group 1 and wooden price group A (see Design Options pages 6-9).
- For top shelves, see from page 340
- For shelves, see from page 328
- For slat panels, see from page 351 (note slate panel replaces outer panel)

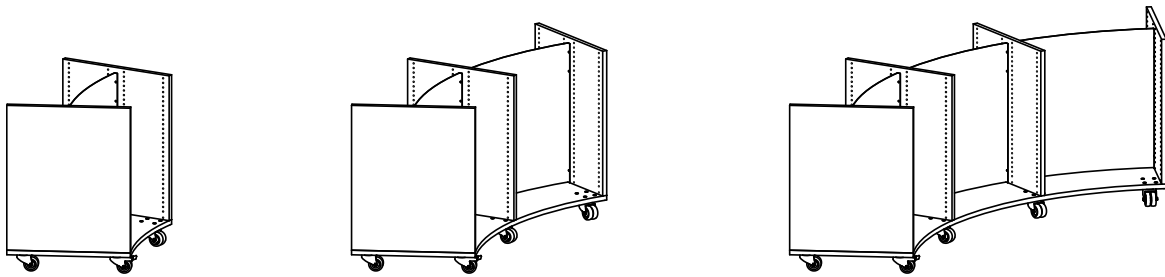

Double-sided H920 mm - 1/2/3 bays

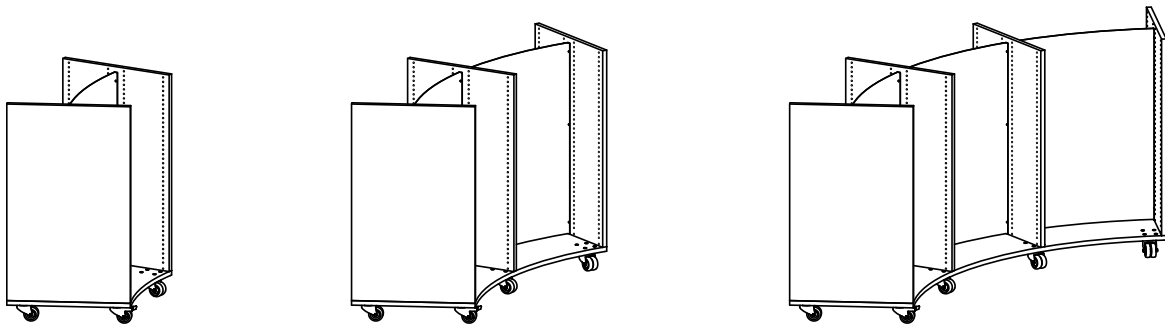

Double-sided H1220 mm - 1/2/3 bays

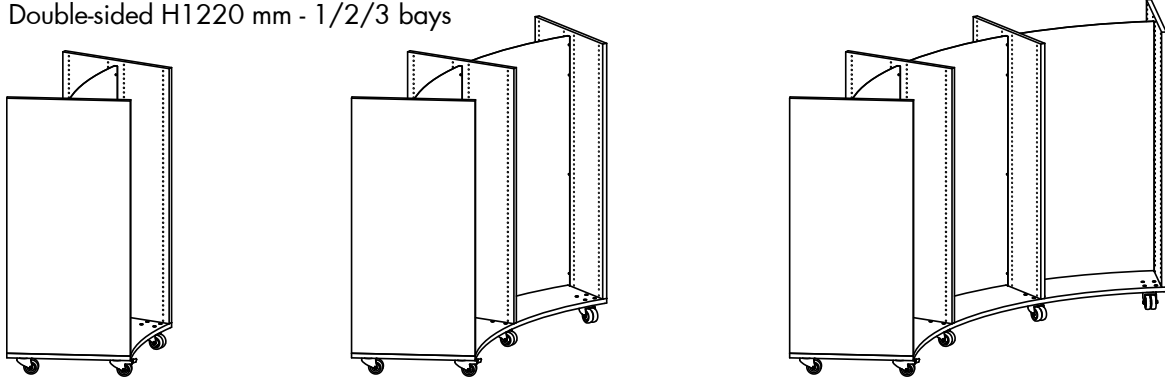

Double-sided H1520 mm - 1/2/3 bays

LINGO ROUND SHELVING SYSTEM

26° - LOW STEEL BACK PANEL - CASTOR PLATE - FOR TOP SHELF

Painted and veneered Lingo Shelving Systems are FSC-certified.

H920 mm

No. of bays	Item no.	Melamine EUR	Painted EUR	Veneer EUR
1	BBN211136010007.	-	-	-
2	BBN211136020007.	-	-	-
3	BBN211136030007.	-	-	-

H1220 mm

No. of bays	Item no.	Melamine EUR	Painted EUR	Veneer EUR
1	BBN211146010007.	-	-	-
2	BBN211146020007.	-	-	-
3	BBN211146030007.	-	-	-

H1520 mm

No. of bays	Item no.	Melamine EUR	Painted EUR	Veneer EUR
1	BBN211156010007.	-	-	-
2	BBN211156020007.	-	-	-
3	BBN211156030007.	-	-	-

LINGO ROUND SHELVING SYSTEM

26° - LOW STEEL BACK PANEL - CASTOR PLATE - FOR TOP SHELF

LINGO ROUND SHELVING SYSTEM

BBN212 - 26° - STEEL BACK FRAME - CASTOR PLATE - WITH OVERLAYING TOP PLATE



LINGO ROUND SHELVING SYSTEM

BBN212 - 26° - STEEL BACK FRAME - CASTOR PLATE - WITH OVERLAYING TOP PLATE

Round shelving system with wooden panels, steel back frame, castor plate and overlaying top plate.

- Prices based on steel price group 1 and wooden price group A (see Design Options pages 6-9).
- For shelves, see from page 328

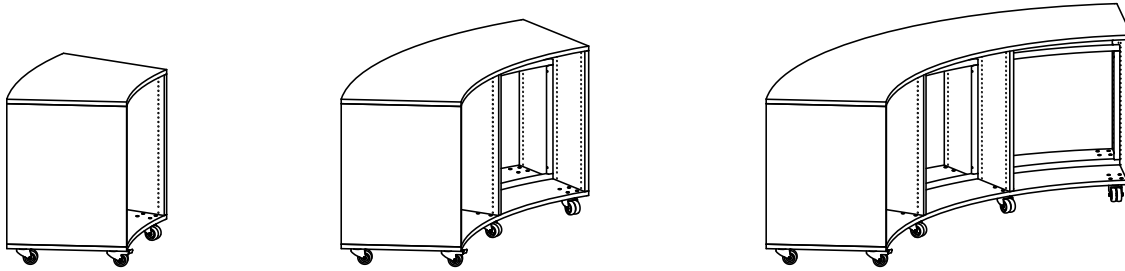

Double-sided H920 mm - 1/2/3 bays

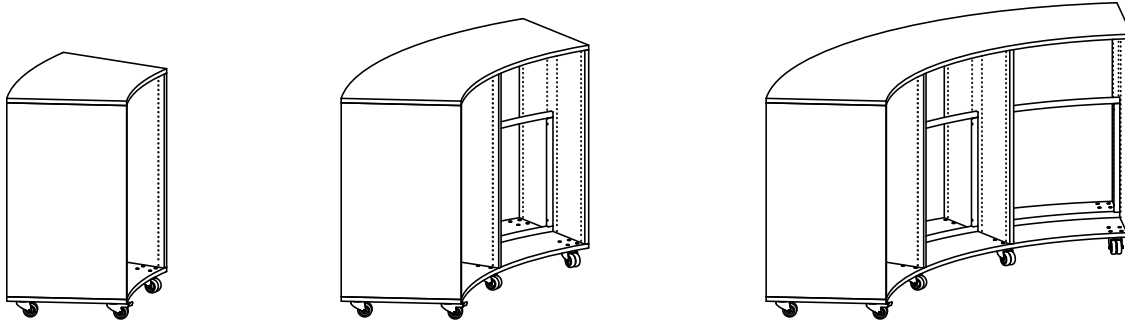

Double-sided H1220 mm - 1/2/3 bays

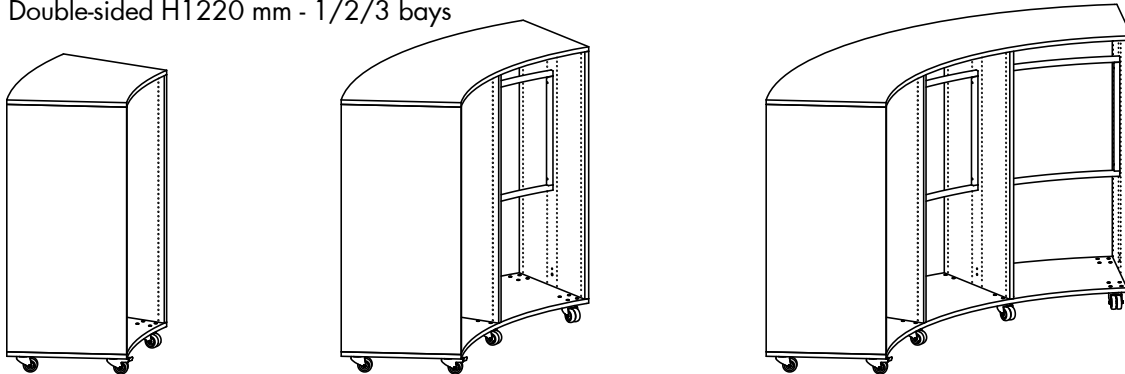

Double-sided H1520 mm - 1/2/3 bays

LINGO ROUND SHELVING SYSTEM

26° - STEEL BACK FRAME - CASTOR PLATE - WITH OVERLAYING TOP PLATE

Painted and veneered Lingo Shelving Systems are FSC-certified.

H920 mm

No. of bays	Item no.	Melamine EUR	Painted EUR	Veneer EUR
1	BBN212136011006.	-	-	-
2	BBN212136021006.	-	-	-
3	BBN212136031006.	-	-	-

H1220 mm

No. of bays	Item no.	Melamine EUR	Painted EUR	Veneer EUR
1	BBN212146011006.	-	-	-
2	BBN212146021006.	-	-	-
3	BBN212146031006.	-	-	-

H1520 mm

No. of bays	Item no.	Melamine EUR	Painted EUR	Veneer EUR
1	BBN212156011006.	-	-	-
2	BBN212156021006.	-	-	-
3	BBN212156031006.	-	-	-

LINGO ROUND SHELVING SYSTEM

26° - STEEL BACK FRAME - CASTOR PLATE - WITH OVERLAYING TOP PLATE

LINGO ROUND SHELVING SYSTEM

BBN212 - 26° - STEEL BACK PANEL - CASTOR PLATE - WITH OVERLAYING TOP PLATE



LINGO ROUND SHELVING SYSTEM

BBN212 - 26° - STEEL BACK PANEL - CASTOR PLATE - WITH OVERLAYING TOP PLATE

Round shelving system with wooden panels, steel back panel, castor plate and overlaying top plate.

- Prices based on steel price group 1 and wooden price group A (see Design Options pages 6-9).
- For shelves, see from page 328

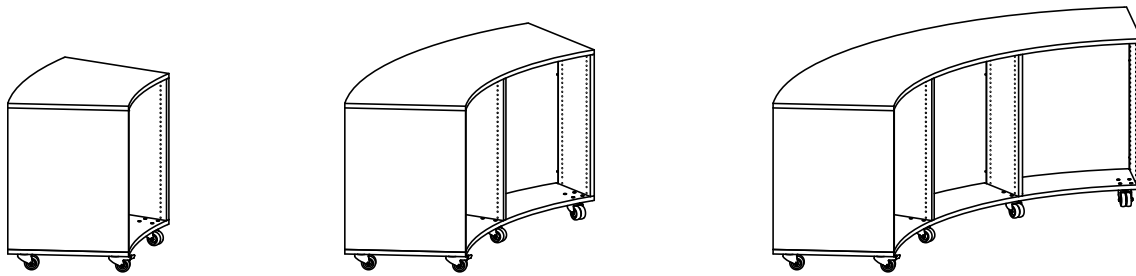

Double-sided H920 mm - 1/2/3 bays

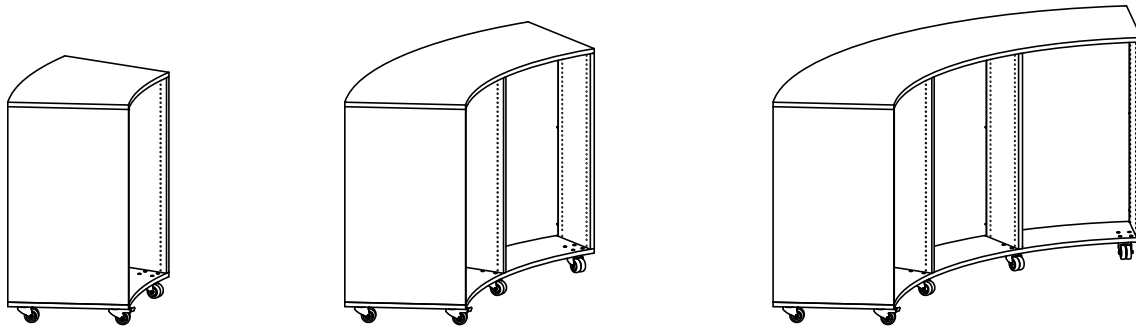

Double-sided H1220 mm - 1/2/3 bays

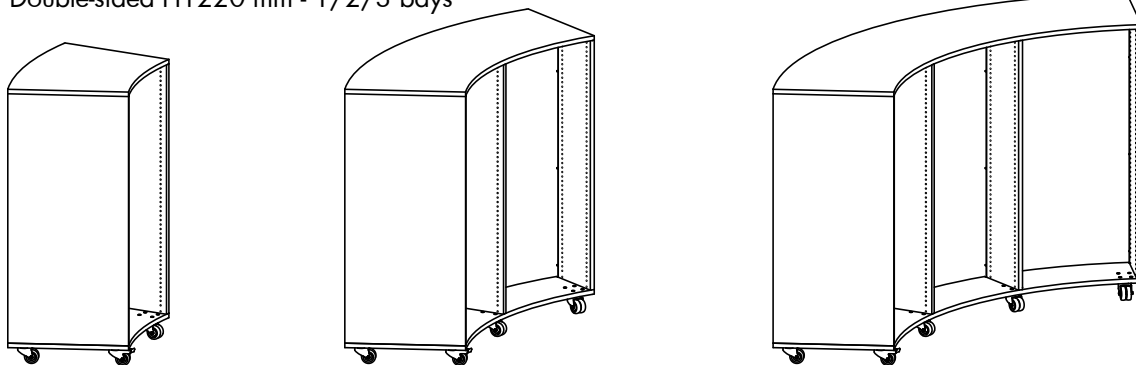

Double-sided H1520 mm - 1/2/3 bays

LINGO ROUND SHELVING SYSTEM

26° - STEEL BACK PANEL - CASTOR PLATE - WITH OVERLAYING TOP PLATE

Painted and veneered Lingo Shelving Systems are FSC-certified.

H920 mm

No. of bays	Item no.	Melamine EUR	Painted EUR	Veneer EUR
1	BBN212136011008.	-	-	-
2	BBN212136021008.	-	-	-
3	BBN212136031008.	-	-	-

H1220 mm

No. of bays	Item no.	Melamine EUR	Painted EUR	Veneer EUR
1	BBN212146011008.	-	-	-
2	BBN212146021008.	-	-	-
3	BBN212146031008.	-	-	-

H1520 mm

No. of bays	Item no.	Melamine EUR	Painted EUR	Veneer EUR
1	BBN212156011008.	-	-	-
2	BBN212156021008.	-	-	-
3	BBN212156031008.	-	-	-

LINGO ROUND SHELVING SYSTEM

26° - STEEL BACK PANEL - CASTOR PLATE - WITH OVERLAYING TOP PLATE

LINGO ROUND SHELVING SYSTEM

BBN221 - 18° - STEEL BACK FRAME - ADJUSTABLE FEET - FOR TOP SHELF



LINGO ROUND SHELVING SYSTEM

BBN221 - 18° - STEEL BACK FRAME - ADJUSTABLE FEET - FOR TOP SHELF

Round shelving system with wooden panels and steel back frame. To be used with top shelf.
Freestanding bay includes 2 end wooden panels and 1 or 2 steel back frame depending on height.
Intermediate bay includes 1 intermediate wooden panel and 1 steel back frame.

- Prices based on steel price group 1 and wooden price group A (see Design Options pages 6-9).
- For top shelves, see from page 340
- For shelves, see from page 328

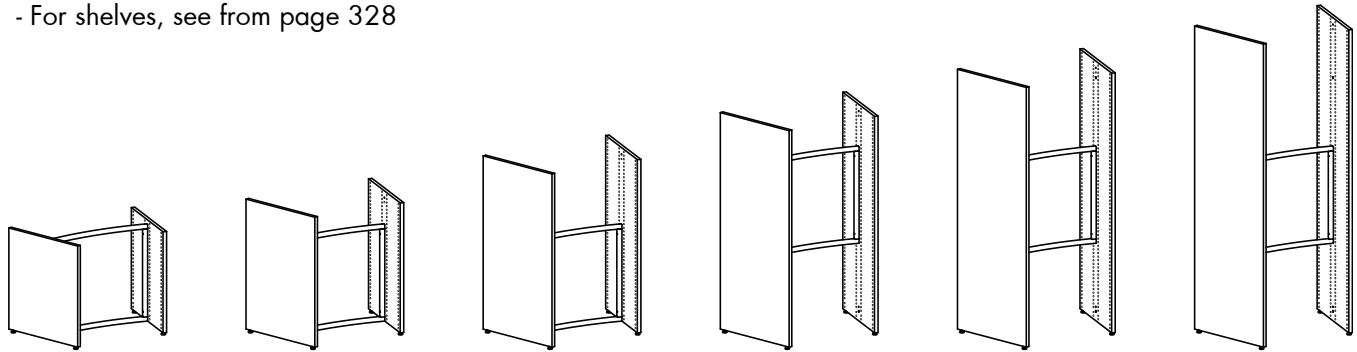

Double-sided freestanding bay - H720/920/1220/1520/1820/2120 mm

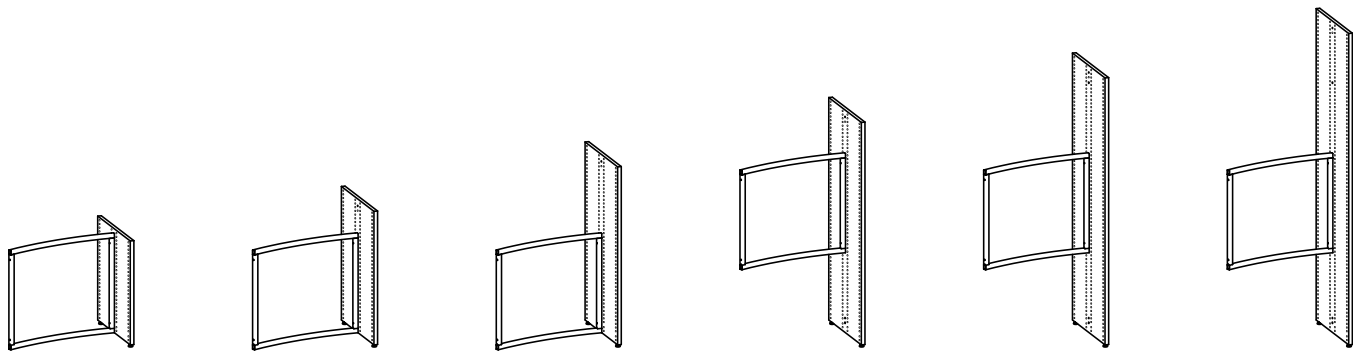

Double-sided intermediate bay - H720/920/1220/1520/1820/2120 mm

LINGO ROUND SHELVING SYSTEM

18° - STEEL BACK FRAME - ADJUSTABLE FEET - FOR TOP SHELF

Painted and veneered Lingo Shelving Systems are FSC-certified.

H720 mm

No. of bays	Item no. Freestanding bay	Melamine EUR	Painted EUR	Veneer EUR	Item no. Intermediate bay	Melamine EUR	Painted EUR	Veneer EUR
1	BBN2211260100060.	-	-	-	BBN2214260100060.	-	-	-
2	BBN2211260200060.	-	-	-	BBN2214260200060.	-	-	-
3	BBN2211260300060.	-	-	-	BBN2214260300060.	-	-	-
4	BBN2211260400060.	-	-	-	BBN2214260400060.	-	-	-
5	BBN2211260500060.	-	-	-	BBN2214260500060.	-	-	-
6	BBN2211260600060.	-	-	-	BBN2214260600060.	-	-	-
7	BBN2211260700060.	-	-	-	BBN2214260700060.	-	-	-
8	BBN2211260800060.	-	-	-	BBN2214260800060.	-	-	-
9	BBN2211260900060.	-	-	-	BBN2214260900060.	-	-	-
10	BBN2211261000060.	-	-	-	BBN2214261000060.	-	-	-
11	BBN2211261100060.	-	-	-				
12	BBN2211261200060.	-	-	-				
13	BBN2211261300060.	-	-	-				
14	BBN2211261400060.	-	-	-				
15	BBN2211261500060.	-	-	-				
16	BBN2211261600060.	-	-	-				
17	BBN2211261700060.	-	-	-				
18	BBN2211261800060.	-	-	-				

H920 mm

No. of bays	Item no. Freestanding bay	Melamine EUR	Painted EUR	Veneer EUR	Item no. Intermediate bay	Melamine EUR	Painted EUR	Veneer EUR
1	BBN2211360100060.	-	-	-	BBN2214360100060.	-	-	-
2	BBN2211360200060.	-	-	-	BBN2214360200060.	-	-	-
3	BBN2211360300060.	-	-	-	BBN2214360300060.	-	-	-
4	BBN2211360400060.	-	-	-	BBN2214360400060.	-	-	-
5	BBN2211360500060.	-	-	-	BBN2214360500060.	-	-	-
6	BBN2211360600060.	-	-	-	BBN2214360600060.	-	-	-
7	BBN2211360700060.	-	-	-	BBN2214360700060.	-	-	-
8	BBN2211360800060.	-	-	-	BBN2214360800060.	-	-	-
9	BBN2211360900060.	-	-	-	BBN2214360900060.	-	-	-
10	BBN2211361000060.	-	-	-	BBN2214361000060.	-	-	-
11	BBN2211361100060.	-	-	-				
12	BBN2211361200060.	-	-	-				
13	BBN2211361300060.	-	-	-				
14	BBN2211361400060.	-	-	-				
15	BBN2211361500060.	-	-	-				
16	BBN2211361600060.	-	-	-				
17	BBN2211361700060.	-	-	-				
18	BBN2211361800060.	-	-	-				

H1220 mm

No. of bays	Item no. Freestanding bay	Melamine EUR	Painted EUR	Veneer EUR	Item no. Intermediate bay	Melamine EUR	Painted EUR	Veneer EUR
1	BBN2211460100060.	-	-	-	BBN2214460100060.	-	-	-
2	BBN2211460200060.	-	-	-	BBN2214460200060.	-	-	-
3	BBN2211460300060.	-	-	-	BBN2214460300060.	-	-	-
4	BBN2211460400060.	-	-	-	BBN2214460400060.	-	-	-
5	BBN2211460500060.	-	-	-	BBN2214460500060.	-	-	-
6	BBN2211460600060.	-	-	-	BBN2214460600060.	-	-	-
7	BBN2211460700060.	-	-	-	BBN2214460700060.	-	-	-
8	BBN2211460800060.	-	-	-	BBN2214460800060.	-	-	-
9	BBN2211460900060.	-	-	-	BBN2214460900060.	-	-	-
10	BBN2211461000060.	-	-	-	BBN2214461000060.	-	-	-
11	BBN2211461100060.	-	-	-				
12	BBN2211461200060.	-	-	-				
13	BBN2211461300060.	-	-	-				
14	BBN2211461400060.	-	-	-				
15	BBN2211461500060.	-	-	-				
16	BBN2211461600060.	-	-	-				
17	BBN2211461700060.	-	-	-				
18	BBN2211461800060.	-	-	-				

LINGO ROUND SHELVING SYSTEM

18° - STEEL BACK FRAME - ADJUSTABLE FEET - FOR TOP SHELF

Painted and veneered Lingo Shelving Systems are FSC-certified.

H1520 mm

No. of bays	Item no. Freestanding bay	Melamine EUR	Painted EUR	Veneer EUR	Item no. Intermediate bay	Melamine EUR	Painted EUR	Veneer EUR
1	BBN2211560100060.	-	-	-	BBN2214560100060.	-	-	-
2	BBN2211560200060.	-	-	-	BBN2214560200060.	-	-	-
3	BBN2211560300060.	-	-	-	BBN2214560300060.	-	-	-
4	BBN2211560400060.	-	-	-	BBN2214560400060.	-	-	-
5	BBN2211560500060.	-	-	-	BBN2214560500060.	-	-	-
6	BBN2211560600060.	-	-	-	BBN2214560600060.	-	-	-
7	BBN2211560700060.	-	-	-	BBN2214560700060.	-	-	-
8	BBN2211560800060.	-	-	-	BBN2214560800060.	-	-	-
9	BBN2211560900060.	-	-	-	BBN2214560900060.	-	-	-
10	BBN2211561000060.	-	-	-	BBN2214561000060.	-	-	-
11	BBN2211561100060.	-	-	-				
12	BBN2211561200060.	-	-	-				
13	BBN2211561300060.	-	-	-				
14	BBN2211561400060.	-	-	-				
15	BBN2211561500060.	-	-	-				
16	BBN2211561600060.	-	-	-				
17	BBN2211561700060.	-	-	-				
18	BBN2211561800060.	-	-	-				

H1820 mm

No. of bays	Item no. Freestanding bay	Melamine EUR	Painted EUR	Veneer EUR	Item no. Intermediate bay	Melamine EUR	Painted EUR	Veneer EUR
1	BBN2211660100060.	-	-	-	BBN2214660100060.	-	-	-
2	BBN2211660200060.	-	-	-	BBN2214660200060.	-	-	-
3	BBN2211660300060.	-	-	-	BBN2214660300060.	-	-	-
4	BBN2211660400060.	-	-	-	BBN2214660400060.	-	-	-
5	BBN2211660500060.	-	-	-	BBN2214660500060.	-	-	-
6	BBN2211660600060.	-	-	-	BBN2214660600060.	-	-	-
7	BBN2211660700060.	-	-	-	BBN2214660700060.	-	-	-
8	BBN2211660800060.	-	-	-	BBN2214660800060.	-	-	-
9	BBN2211660900060.	-	-	-	BBN2214660900060.	-	-	-
10	BBN2211661000060.	-	-	-	BBN2214661000060.	-	-	-
11	BBN2211661100060.	-	-	-				
12	BBN2211661200060.	-	-	-				
13	BBN2211661300060.	-	-	-				
14	BBN2211661400060.	-	-	-				
15	BBN2211661500060.	-	-	-				
16	BBN2211661600060.	-	-	-				
17	BBN2211661700060.	-	-	-				
18	BBN2211661800060.	-	-	-				

H2120 mm

No. of bays	Item no. Freestanding bay	Melamine EUR	Painted EUR	Veneer EUR	Item no. Intermediate bay	Melamine EUR	Painted EUR	Veneer EUR
1	BBN2211760100060.	-	-	-	BBN2214760100060.	-	-	-
2	BBN2211760200060.	-	-	-	BBN2214760200060.	-	-	-
3	BBN2211760300060.	-	-	-	BBN2214760300060.	-	-	-
4	BBN2211760400060.	-	-	-	BBN2214760400060.	-	-	-
5	BBN2211760500060.	-	-	-	BBN2214760500060.	-	-	-
6	BBN2211760600060.	-	-	-	BBN2214760600060.	-	-	-
7	BBN2211760700060.	-	-	-	BBN2214760700060.	-	-	-
8	BBN2211760800060.	-	-	-	BBN2214760800060.	-	-	-
9	BBN2211760900060.	-	-	-	BBN2214760900060.	-	-	-
10	BBN2211761000060.	-	-	-	BBN2214761000060.	-	-	-
11	BBN2211761100060.	-	-	-				
12	BBN2211761200060.	-	-	-				
13	BBN2211761300060.	-	-	-				
14	BBN2211761400060.	-	-	-				
15	BBN2211761500060.	-	-	-				
16	BBN2211761600060.	-	-	-				
17	BBN2211761700060.	-	-	-				
18	BBN2211761800060.	-	-	-				

LINGO ROUND SHELVING SYSTEM

BBN221 - 18° - HIGH STEEL BACK PANEL - ADJUSTABLE FEET - FOR TOP SHELF



LINGO ROUND SHELVING SYSTEM

BBN221 - 18° - HIGH STEEL BACK PANEL - ADJUSTABLE FEET - FOR TOP SHELF

Round shelving system with wooden panels and high steel back panel.

To be used with top shelf WT5 standard depth top shelf.

Freestanding bay includes 2 wooden end panels and 1 high steel back panel.

Intermediate bay includes 1 intermediate wooden panel and 1 high steel back panel.

- Prices based on steel price group 1 and wooden price group A (see Design Options pages 6-9).

- For top shelves, see from page 340

- For shelves, see from page 328

- For castor frame, see page 347

- For end panel bay, see page 358

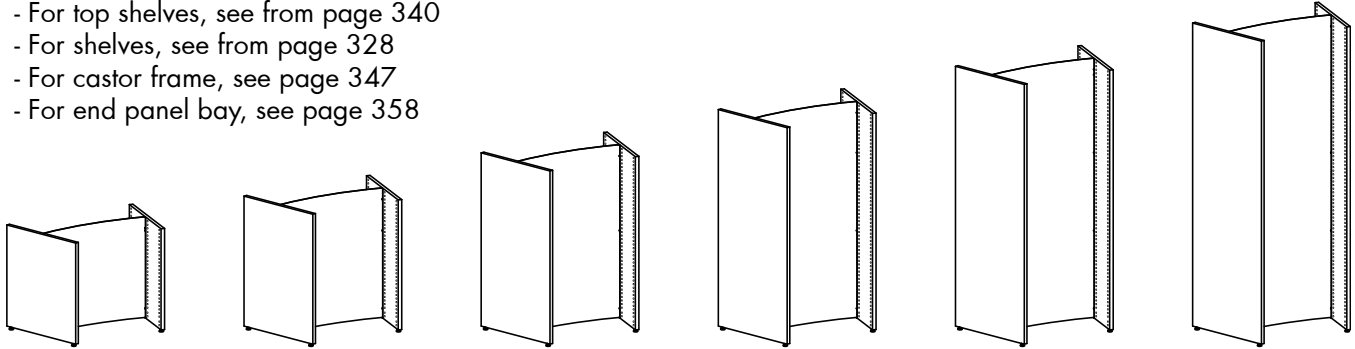

Double-sided freestanding bay - H720/920/1220/1520/1820/2120 mm

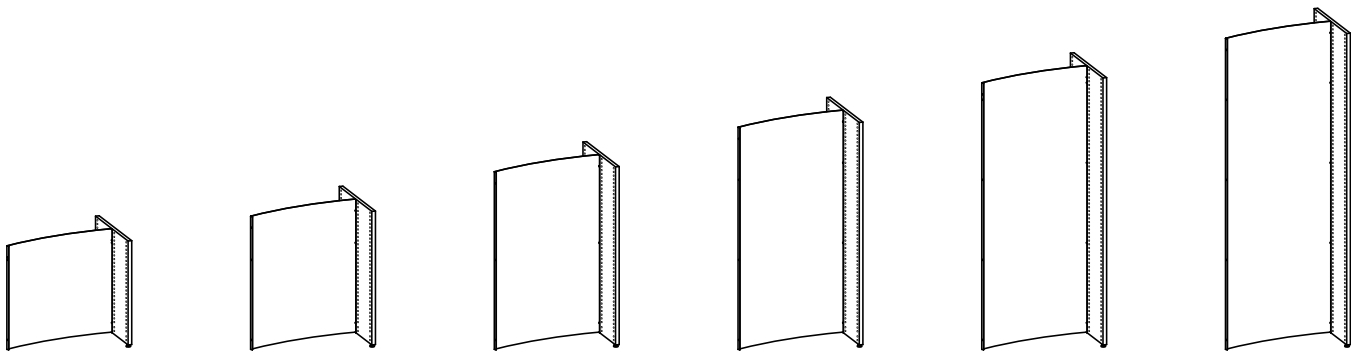

Double-sided intermediate bay - H720/920/1220/1520/1820/2120 mm

LINGO ROUND SHELVING SYSTEM

18° - HIGH STEEL BACK PANEL - ADJUSTABLE FEET - FOR TOP SHELF

Painted and veneered Lingo Shelving Systems are FSC-certified.

H720 mm

No. of bays	Item no. Freestanding bay	Melamine EUR	Painted EUR	Veneer EUR	Item no. Intermediate bay	Melamine EUR	Painted EUR	Veneer EUR
1	BBN2211260100070.	-	-	-	BBN2214260100070.	-	-	-
2	BBN2211260200070.	-	-	-	BBN2214260200070.	-	-	-
3	BBN2211260300070.	-	-	-	BBN2214260300070.	-	-	-
4	BBN2211260400070.	-	-	-	BBN2214260400070.	-	-	-
5	BBN2211260500070.	-	-	-	BBN2214260500070.	-	-	-
6	BBN2211260600070.	-	-	-	BBN2214260600070.	-	-	-
7	BBN2211260700070.	-	-	-	BBN2214260700070.	-	-	-
8	BBN2211260800070.	-	-	-	BBN2214260800070.	-	-	-
9	BBN2211260900070.	-	-	-	BBN2214260900070.	-	-	-
10	BBN2211261000070.	-	-	-	BBN2214261000070.	-	-	-
11	BBN2211261100070.	-	-	-				
12	BBN2211261200070.	-	-	-				
13	BBN2211261300070.	-	-	-				
14	BBN2211261400070.	-	-	-				
15	BBN2211261500070.	-	-	-				
16	BBN2211261600070.	-	-	-				
17	BBN2211261700070.	-	-	-				
18	BBN2211261800070.	-	-	-				

H920 mm

No. of bays	Item no. Freestanding bay	Melamine EUR	Painted EUR	Veneer EUR	Item no. Intermediate bay	Melamine EUR	Painted EUR	Veneer EUR
1	BBN2211360100070.	-	-	-	BBN2214360100070.	-	-	-
2	BBN2211360200070.	-	-	-	BBN2214360200070.	-	-	-
3	BBN2211360300070.	-	-	-	BBN2214360300070.	-	-	-
4	BBN2211360400070.	-	-	-	BBN2214360400070.	-	-	-
5	BBN2211360500070.	-	-	-	BBN2214360500070.	-	-	-
6	BBN2211360600070.	-	-	-	BBN2214360600070.	-	-	-
7	BBN2211360700070.	-	-	-	BBN2214360700070.	-	-	-
8	BBN2211360800070.	-	-	-	BBN2214360800070.	-	-	-
9	BBN2211360900070.	-	-	-	BBN2214360900070.	-	-	-
10	BBN2211361000070.	-	-	-	BBN2214361000070.	-	-	-
11	BBN2211361100070.	-	-	-				
12	BBN2211361200070.	-	-	-				
13	BBN2211361300070.	-	-	-				
14	BBN2211361400070.	-	-	-				
15	BBN2211361500070.	-	-	-				
16	BBN2211361600070.	-	-	-				
17	BBN2211361700070.	-	-	-				
18	BBN2211361800070.	-	-	-				

H1220 mm

No. of bays	Item no. Freestanding bay	Melamine EUR	Painted EUR	Veneer EUR	Item no. Intermediate bay	Melamine EUR	Painted EUR	Veneer EUR
1	BBN2211460100070.	-	-	-	BBN2214460100070.	-	-	-
2	BBN2211460200070.	-	-	-	BBN2214460200070.	-	-	-
3	BBN2211460300070.	-	-	-	BBN2214460300070.	-	-	-
4	BBN2211460400070.	-	-	-	BBN2214460400070.	-	-	-
5	BBN2211460500070.	-	-	-	BBN2214460500070.	-	-	-
6	BBN2211460600070.	-	-	-	BBN2214460600070.	-	-	-
7	BBN2211460700070.	-	-	-	BBN2214460700070.	-	-	-
8	BBN2211460800070.	-	-	-	BBN2214460800070.	-	-	-
9	BBN2211460900070.	-	-	-	BBN2214460900070.	-	-	-
10	BBN2211461000070.	-	-	-	BBN2214461000070.	-	-	-
11	BBN2211461100070.	-	-	-				
12	BBN2211461200070.	-	-	-				
13	BBN2211461300070.	-	-	-				
14	BBN2211461400070.	-	-	-				
15	BBN2211461500070.	-	-	-				
16	BBN2211461600070.	-	-	-				
17	BBN2211461700070.	-	-	-				
18	BBN2211461800070.	-	-	-				

LINGO ROUND SHELVING SYSTEM

18° - HIGH STEEL BACK PANEL - ADJUSTABLE FEET - FOR TOP SHELF

Painted and veneered Lingo Shelving Systems are FSC-certified.

H1520 mm

No. of bays	Item no. Freestanding bay	Melamine EUR	Painted EUR	Veneer EUR	Item no. Intermediate bay	Melamine EUR	Painted EUR	Veneer EUR
1	BBN2211560100070.	-	-	-	BBN2214560100070.	-	-	-
2	BBN2211560200070.	-	-	-	BBN2214560200070.	-	-	-
3	BBN2211560300070.	-	-	-	BBN2214560300070.	-	-	-
4	BBN2211560400070.	-	-	-	BBN2214560400070.	-	-	-
5	BBN2211560500070.	-	-	-	BBN2214560500070.	-	-	-
6	BBN2211560600070.	-	-	-	BBN2214560600070.	-	-	-
7	BBN2211560700070.	-	-	-	BBN2214560700070.	-	-	-
8	BBN2211560800070.	-	-	-	BBN2214560800070.	-	-	-
9	BBN2211560900070.	-	-	-	BBN2214560900070.	-	-	-
10	BBN2211561000070.	-	-	-	BBN2214561000070.	-	-	-
11	BBN2211561100070.	-	-	-				
12	BBN2211561200070.	-	-	-				
13	BBN2211561300070.	-	-	-				
14	BBN2211561400070.	-	-	-				
15	BBN2211561500070.	-	-	-				
16	BBN2211561600070.	-	-	-				
17	BBN2211561700070.	-	-	-				
18	BBN2211561800070.	-	-	-				

H1820 mm

No. of bays	Item no. Freestanding bay	Melamine EUR	Painted EUR	Veneer EUR	Item no. Intermediate bay	Melamine EUR	Painted EUR	Veneer EUR
1	BBN2211660100070.	-	-	-	BBN2214660100070.	-	-	-
2	BBN2211660200070.	-	-	-	BBN2214660200070.	-	-	-
3	BBN2211660300070.	-	-	-	BBN2214660300070.	-	-	-
4	BBN2211660400070.	-	-	-	BBN2214660400070.	-	-	-
5	BBN2211660500070.	-	-	-	BBN2214660500070.	-	-	-
6	BBN2211660600070.	-	-	-	BBN2214660600070.	-	-	-
7	BBN2211660700070.	-	-	-	BBN2214660700070.	-	-	-
8	BBN2211660800070.	-	-	-	BBN2214660800070.	-	-	-
9	BBN2211660900070.	-	-	-	BBN2214660900070.	-	-	-
10	BBN2211661000070.	-	-	-	BBN2214661000070.	-	-	-
11	BBN2211661100070.	-	-	-				
12	BBN2211661200070.	-	-	-				
13	BBN2211661300070.	-	-	-				
14	BBN2211661400070.	-	-	-				
15	BBN2211661500070.	-	-	-				
16	BBN2211661600070.	-	-	-				
17	BBN2211661700070.	-	-	-				
18	BBN2211661800070.	-	-	-				

H2120 mm

No. of bays	Item no. Freestanding bay	Melamine EUR	Painted EUR	Veneer EUR	Item no. Intermediate bay	Melamine EUR	Painted EUR	Veneer EUR
1	BBN2211760100070.	-	-	-	BBN2214760100070.	-	-	-
2	BBN2211760200070.	-	-	-	BBN2214760200070.	-	-	-
3	BBN2211760300070.	-	-	-	BBN2214760300070.	-	-	-
4	BBN2211760400070.	-	-	-	BBN2214760400070.	-	-	-
5	BBN2211760500070.	-	-	-	BBN2214760500070.	-	-	-
6	BBN2211760600070.	-	-	-	BBN2214760600070.	-	-	-
7	BBN2211760700070.	-	-	-	BBN2214760700070.	-	-	-
8	BBN2211760800070.	-	-	-	BBN2214760800070.	-	-	-
9	BBN2211760900070.	-	-	-	BBN2214760900070.	-	-	-
10	BBN2211761000070.	-	-	-	BBN2214761000070.	-	-	-
11	BBN2211761100070.	-	-	-				
12	BBN2211761200070.	-	-	-				
13	BBN2211761300070.	-	-	-				
14	BBN2211761400070.	-	-	-				
15	BBN2211761500070.	-	-	-				
16	BBN2211761600070.	-	-	-				
17	BBN2211761700070.	-	-	-				
18	BBN2211761800070.	-	-	-				

LINGO ROUND SHELVING SYSTEM

BBN221 - 18° - LOW STEEL BACK PANEL - ADJUSTABLE FEET - FOR TOP SHELF



LINGO ROUND SHELVING SYSTEM

BBN221 - 18° - LOW STEEL BACK PANEL - ADJUSTABLE FEET - FOR TOP SHELF

Round shelving system with wooden panels and low steel back panel.

To be used with top shelves WT5 full depth and WT5 double-sided top shelf.

Freestanding bay includes 2 end wooden panels and 1 low steel back panel.

Intermediate bay includes 1 intermediate wooden panel and 1 low steel back panel.

- Prices based on steel price group 1 and wooden price group A (see Design Options pages 6-9).

- For top shelves, see from page 340

- For shelves, see from page 328

- For plinths, see page 349

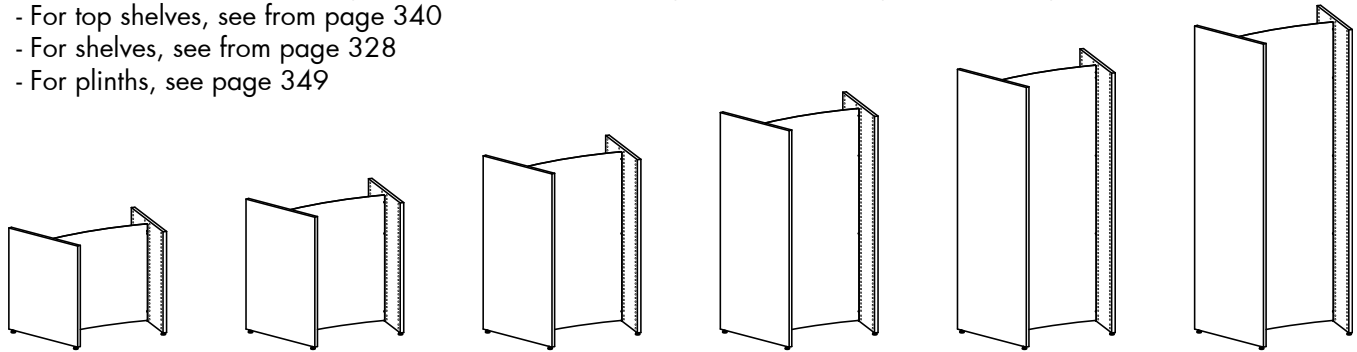

Double-sided freestanding bay - H720/920/1220/1520/1820/2120 mm

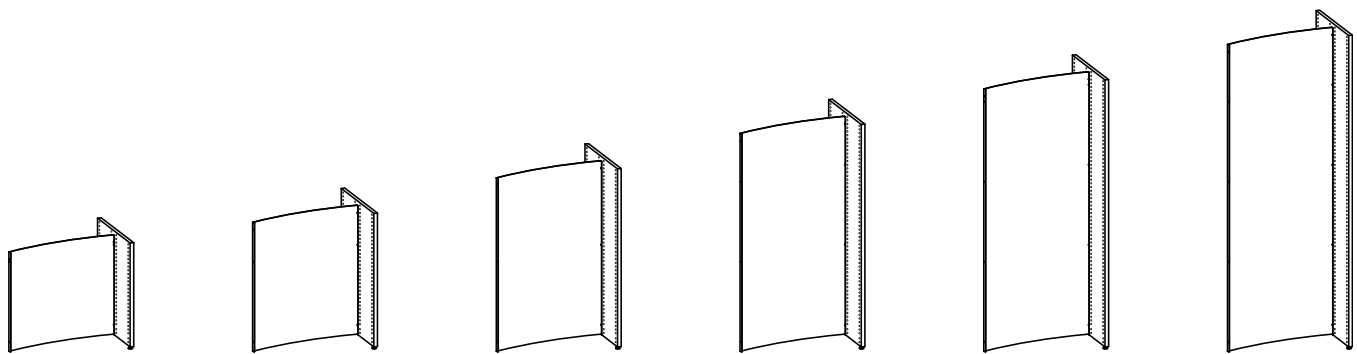

Double-sided intermediate bay - H720/920/1220/1520/1820/2120 mm

LINGO ROUND SHELVING SYSTEM

18° - LOW STEEL BACK PANEL - ADJUSTABLE FEET - FOR TOP SHELF

Painted and veneered Lingo Shelving Systems are FSC-certified.

H720 mm

No. of bays	Item no. Freestanding bay	Melamine EUR	Painted EUR	Veneer EUR	Item no. Intermediate bay	Melamine EUR	Painted EUR	Veneer EUR
1	BBN2211260100080.	-	-	-	BBN2214260100080.	-	-	-
2	BBN2211260200080.	-	-	-	BBN2214260200080.	-	-	-
3	BBN2211260300080.	-	-	-	BBN2214260300080.	-	-	-
4	BBN2211260400080.	-	-	-	BBN2214260400080.	-	-	-
5	BBN2211260500080.	-	-	-	BBN2214260500080.	-	-	-
6	BBN2211260600080.	-	-	-	BBN2214260600080.	-	-	-
7	BBN2211260700080.	-	-	-	BBN2214260700080.	-	-	-
8	BBN2211260800080.	-	-	-	BBN2214260800080.	-	-	-
9	BBN2211260900080.	-	-	-	BBN2214260900080.	-	-	-
10	BBN2211261000080.	-	-	-	BBN2214261000080.	-	-	-
11	BBN2211261100080.	-	-	-				
12	BBN2211261200080.	-	-	-				
13	BBN2211261300080.	-	-	-				
14	BBN2211261400080.	-	-	-				
15	BBN2211261500080.	-	-	-				
16	BBN2211261600080.	-	-	-				
17	BBN2211261700080.	-	-	-				
18	BBN2211261800080.	-	-	-				

H920 mm

No. of bays	Item no. Freestanding bay	Melamine EUR	Painted EUR	Veneer EUR	Item no. Intermediate bay	Melamine EUR	Painted EUR	Veneer EUR
1	BBN2211360100080.	-	-	-	BBN2214360100080.	-	-	-
2	BBN2211360200080.	-	-	-	BBN2214360200080.	-	-	-
3	BBN2211360300080.	-	-	-	BBN2214360300080.	-	-	-
4	BBN2211360400080.	-	-	-	BBN2214360400080.	-	-	-
5	BBN2211360500080.	-	-	-	BBN2214360500080.	-	-	-
6	BBN2211360600080.	-	-	-	BBN2214360600080.	-	-	-
7	BBN2211360700080.	-	-	-	BBN2214360700080.	-	-	-
8	BBN2211360800080.	-	-	-	BBN2214360800080.	-	-	-
9	BBN2211360900080.	-	-	-	BBN2214360900080.	-	-	-
10	BBN2211361000080.	-	-	-	BBN2214361000080.	-	-	-
11	BBN2211361100080.	-	-	-				
12	BBN2211361200080.	-	-	-				
13	BBN2211361300080.	-	-	-				
14	BBN2211361400080.	-	-	-				
15	BBN2211361500080.	-	-	-				
16	BBN2211361600080.	-	-	-				
17	BBN2211361700080.	-	-	-				
18	BBN2211361800080.	-	-	-				

H1220 mm

No. of bays	Item no. Freestanding bay	Melamine EUR	Painted EUR	Veneer EUR	Item no. Intermediate bay	Melamine EUR	Painted EUR	Veneer EUR
1	BBN2211460100080.	-	-	-	BBN2214460100080.	-	-	-
2	BBN2211460200080.	-	-	-	BBN2214460200080.	-	-	-
3	BBN2211460300080.	-	-	-	BBN2214460300080.	-	-	-
4	BBN2211460400080.	-	-	-	BBN2214460400080.	-	-	-
5	BBN2211460500080.	-	-	-	BBN2214460500080.	-	-	-
6	BBN2211460600080.	-	-	-	BBN2214460600080.	-	-	-
7	BBN2211460700080.	-	-	-	BBN2214460700080.	-	-	-
8	BBN2211460800080.	-	-	-	BBN2214460800080.	-	-	-
9	BBN2211460900080.	-	-	-	BBN2214460900080.	-	-	-
10	BBN2211461000080.	-	-	-	BBN2214461000080.	-	-	-
11	BBN2211461100080.	-	-	-				
12	BBN2211461200080.	-	-	-				
13	BBN2211461300080.	-	-	-				
14	BBN2211461400080.	-	-	-				
15	BBN2211461500080.	-	-	-				
16	BBN2211461600080.	-	-	-				
17	BBN2211461700080.	-	-	-				
18	BBN2211461800080.	-	-	-				

LINGO ROUND SHELVING SYSTEM

18° - LOW STEEL BACK PANEL - ADJUSTABLE FEET - FOR TOP SHELF

Painted and veneered Lingo Shelving Systems are FSC-certified.

H1520 mm

No. of bays	Item no. Freestanding bay	Melamine EUR	Painted EUR	Veneer EUR	Item no. Intermediate bay	Melamine EUR	Painted EUR	Veneer EUR
1	BBN2211560100080.	-	-	-	BBN2214560100080.	-	-	-
2	BBN2211560200080.	-	-	-	BBN2214560200080.	-	-	-
3	BBN2211560300080.	-	-	-	BBN2214560300080.	-	-	-
4	BBN2211560400080.	-	-	-	BBN2214560400080.	-	-	-
5	BBN2211560500080.	-	-	-	BBN2214560500080.	-	-	-
6	BBN2211560600080.	-	-	-	BBN2214560600080.	-	-	-
7	BBN2211560700080.	-	-	-	BBN2214560700080.	-	-	-
8	BBN2211560800080.	-	-	-	BBN2214560800080.	-	-	-
9	BBN2211560900080.	-	-	-	BBN2214560900080.	-	-	-
10	BBN2211561000080.	-	-	-	BBN2214561000080.	-	-	-
11	BBN2211561100080.	-	-	-				
12	BBN2211561200080.	-	-	-				
13	BBN2211561300080.	-	-	-				
14	BBN2211561400080.	-	-	-				
15	BBN2211561500080.	-	-	-				
16	BBN2211561600080.	-	-	-				
17	BBN2211561700080.	-	-	-				
18	BBN2211561800080.	-	-	-				

H1820 mm

No. of bays	Item no. Freestanding bay	Melamine EUR	Painted EUR	Veneer EUR	Item no. Intermediate bay	Melamine EUR	Painted EUR	Veneer EUR
1	BBN2211660100080.	-	-	-	BBN2214660100080.	-	-	-
2	BBN2211660200080.	-	-	-	BBN2214660200080.	-	-	-
3	BBN2211660300080.	-	-	-	BBN2214660300080.	-	-	-
4	BBN2211660400080.	-	-	-	BBN2214660400080.	-	-	-
5	BBN2211660500080.	-	-	-	BBN2214660500080.	-	-	-
6	BBN2211660600080.	-	-	-	BBN2214660600080.	-	-	-
7	BBN2211660700080.	-	-	-	BBN2214660700080.	-	-	-
8	BBN2211660800080.	-	-	-	BBN2214660800080.	-	-	-
9	BBN2211660900080.	-	-	-	BBN2214660900080.	-	-	-
10	BBN2211661000080.	-	-	-	BBN2214661000080.	-	-	-
11	BBN2211661100080.	-	-	-				
12	BBN2211661200080.	-	-	-				
13	BBN2211661300080.	-	-	-				
14	BBN2211661400080.	-	-	-				
15	BBN2211661500080.	-	-	-				
16	BBN2211661600080.	-	-	-				
17	BBN2211661700080.	-	-	-				
18	BBN2211661800080.	-	-	-				

H2120 mm

No. of bays	Item no. Freestanding bay	Melamine EUR	Painted EUR	Veneer EUR	Item no. Intermediate bay	Melamine EUR	Painted EUR	Veneer EUR
1	BBN2211760100080.	-	-	-	BBN2214760100080.	-	-	-
2	BBN2211760200080.	-	-	-	BBN2214760200080.	-	-	-
3	BBN2211760300080.	-	-	-	BBN2214760300080.	-	-	-
4	BBN2211760400080.	-	-	-	BBN2214760400080.	-	-	-
5	BBN2211760500080.	-	-	-	BBN2214760500080.	-	-	-
6	BBN2211760600080.	-	-	-	BBN2214760600080.	-	-	-
7	BBN2211760700080.	-	-	-	BBN2214760700080.	-	-	-
8	BBN2211760800080.	-	-	-	BBN2214760800080.	-	-	-
9	BBN2211760900080.	-	-	-	BBN2214760900080.	-	-	-
10	BBN2211761000080.	-	-	-	BBN2214761000080.	-	-	-
11	BBN2211761100080.	-	-	-				
12	BBN2211761200080.	-	-	-				
13	BBN2211761300080.	-	-	-				
14	BBN2211761400080.	-	-	-				
15	BBN2211761500080.	-	-	-				
16	BBN2211761600080.	-	-	-				
17	BBN2211761700080.	-	-	-				
18	BBN2211761800080.	-	-	-				

LINGO ROUND SHELVING SYSTEM

BBN222 - 18° - STEEL BACK FRAME - ADJUSTABLE FEET - WITH TOP PLATE



LINGO ROUND SHELVING SYSTEM

BBN222 - 18° - STEEL BACK FRAME - ADJUSTABLE FEET - WITH TOP PLATE

Round shelving system with wooden end panels, intermediate panels, steel back frame and overlaying top plate. See further description on starter, intermediate and end sections on pages 26-27.

- Prices based on steel price group 1 and wooden price group A (see Design Options pages 6-9).
- For shelves, see from page 328
- For end panel bays, see page 378
- For plinths, see page 349

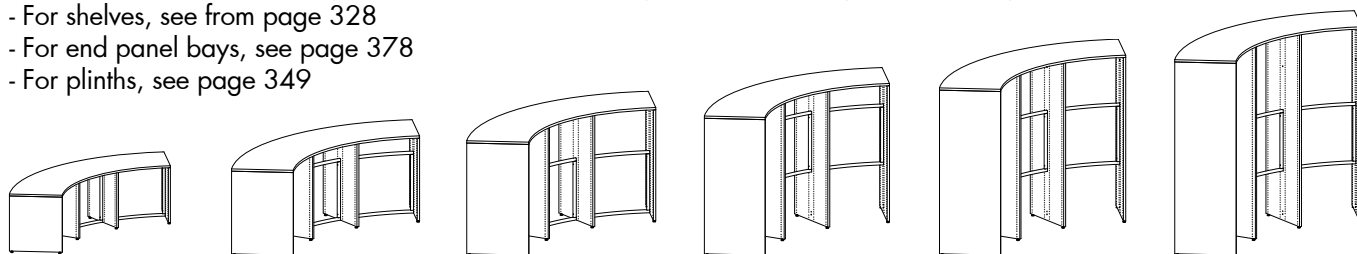

Freestanding 26° double-sided bays - H720/920/1220/1520/1820/2120 mm

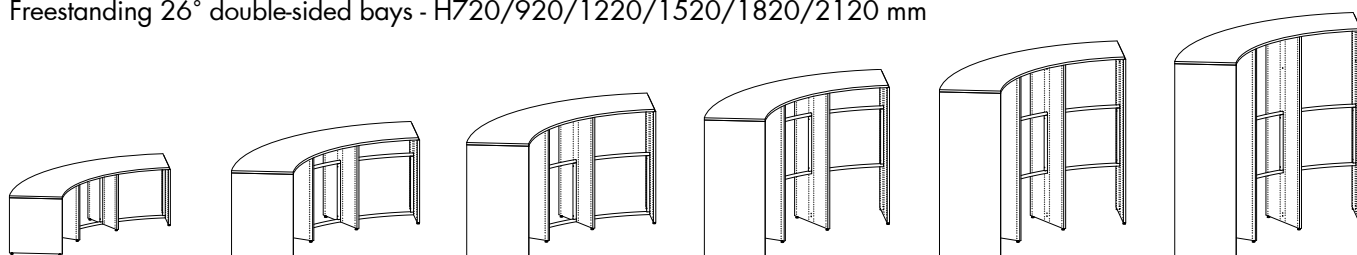

Left starter 26° double-sided bays - H720/920/1220/1520/1820/2120 mm

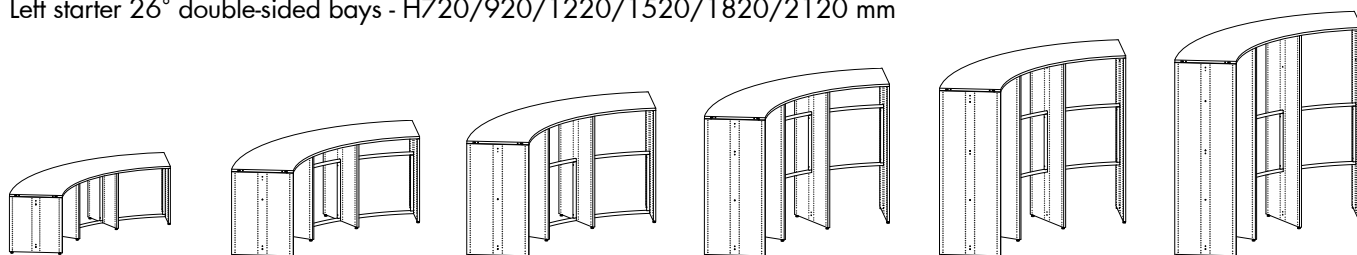

Right starter 26° double-sided bays - H720/920/1220/1520/1820/2120 mm

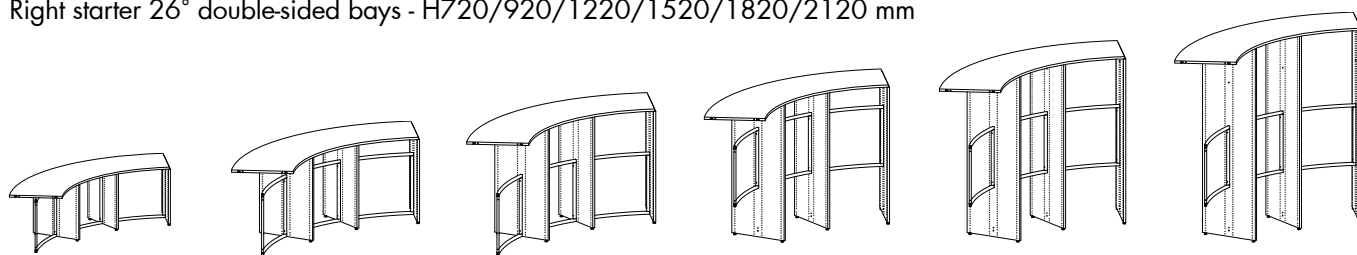

Intermediate 26° double-sided bays - H720/920/1220/1520/1820/2120 mm

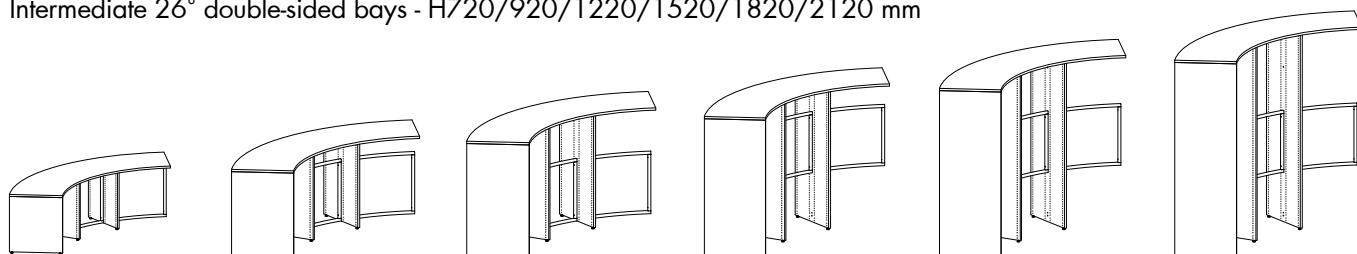

Left end 26° double-sided bays - H720/920/1220/1520/1820/2120 mm

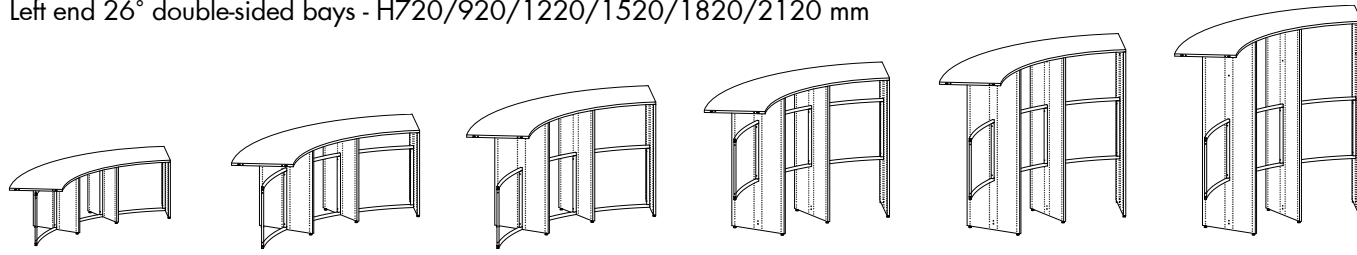

Right end 26° double-sided bays - H720/920/1220/1520/1820/2120 mm

LINGO ROUND SHELVING SYSTEM

18° - STEEL BACK FRAME - ADJUSTABLE FEET - WITH TOP PLATE - FREESTANDING SECTION

Painted and veneered Lingo Shelving Systems are FSC-certified.

H720 mm

No. of bays	Item no.	Melamine EUR	Painted EUR	Veneer EUR
1	BBN2221260110060.	-	-	-
2	BBN2221260210060.	-	-	-
3	BBN2221260310060.	-	-	-

H920 mm

No. of bays	Item no.	Melamine EUR	Painted EUR	Veneer EUR
1	BBN2221360110060.	-	-	-
2	BBN2221360210060.	-	-	-
3	BBN2221360310060.	-	-	-

H1220 mm

No. of bays	Item no.	Melamine EUR	Painted EUR	Veneer EUR
1	BBN2221460110060.	-	-	-
2	BBN2221460210060.	-	-	-
3	BBN2221460310060.	-	-	-

H1520 mm

No. of bays	Item no.	Melamine EUR	Painted EUR	Veneer EUR
1	BBN2221560110060.	-	-	-
2	BBN2221560210060.	-	-	-
3	BBN2221560310060.	-	-	-

H1820 mm

No. of bays	Item no.	Melamine EUR	Painted EUR	Veneer EUR
1	BBN2221660110060.	-	-	-
2	BBN2221660210060.	-	-	-
3	BBN2221660310060.	-	-	-

H2120 mm

No. of bays	Item no.	Melamine EUR	Painted EUR	Veneer EUR
1	BBN2221760110060.	-	-	-
2	BBN2221760210060.	-	-	-
3	BBN2221760310060.	-	-	-

LINGO ROUND SHELVING SYSTEM

18° - STEEL BACK FRAME - ADJUSTABLE FEET - WITH TOP PLATE - LEFT STARTER SECTION

Painted and veneered Lingo Shelving Systems are FSC-certified.

H720 mm

No. of bays	Item no.	Melamine EUR	Painted EUR	Veneer EUR
1	BBN2222260110060.	-	-	-
2	BBN2222260210060.	-	-	-
3	BBN2222260310060.	-	-	-

H920 mm

No. of bays	Item no.	Melamine EUR	Painted EUR	Veneer EUR
1	BBN2222360110060.	-	-	-
2	BBN2222360210060.	-	-	-
3	BBN2222360310060.	-	-	-

H1220 mm

No. of bays	Item no.	Melamine EUR	Painted EUR	Veneer EUR
1	BBN2222460110060.	-	-	-
2	BBN2222460210060.	-	-	-
3	BBN2222460310060.	-	-	-

H1520 mm

No. of bays	Item no.	Melamine EUR	Painted EUR	Veneer EUR
1	BBN2222560110060.	-	-	-
2	BBN2222560210060.	-	-	-
3	BBN2222560310060.	-	-	-

H1820 mm

No. of bays	Item no.	Melamine EUR	Painted EUR	Veneer EUR
1	BBN2222660110060.	-	-	-
2	BBN2222660210060.	-	-	-
3	BBN2222660310060.	-	-	-

H2120 mm

No. of bays	Item no.	Melamine EUR	Painted EUR	Veneer EUR
1	BBN2222760110060.	-	-	-
2	BBN2222760210060.	-	-	-
3	BBN2222760310060.	-	-	-

LINGO ROUND SHELVING SYSTEM

18° - STEEL BACK FRAME - ADJUSTABLE FEET - WITH TOP PLATE - RIGHT STARTER SECTION

Painted and veneered Lingo Shelving Systems are FSC-certified.

H720 mm

No. of bays	Item no.	Melamine EUR	Painted EUR	Veneer EUR
1	BBN2223260110060.	-	-	-
2	BBN2223260210060.	-	-	-
3	BBN2223260310060.	-	-	-

H920 mm

No. of bays	Item no.	Melamine EUR	Painted EUR	Veneer EUR
1	BBN2223360110060.	-	-	-
2	BBN2223360210060.	-	-	-
3	BBN2223360310060.	-	-	-

H1220 mm

No. of bays	Item no.	Melamine EUR	Painted EUR	Veneer EUR
1	BBN2223460110060.	-	-	-
2	BBN2223460210060.	-	-	-
3	BBN2223460310060.	-	-	-

H1520 mm

No. of bays	Item no.	Melamine EUR	Painted EUR	Veneer EUR
1	BBN2223560110060.	-	-	-
2	BBN2223560210060.	-	-	-
3	BBN2223560310060.	-	-	-

H1820 mm

No. of bays	Item no.	Melamine EUR	Painted EUR	Veneer EUR
1	BBN2223660110060.	-	-	-
2	BBN2223660210060.	-	-	-
3	BBN2223660310060.	-	-	-

H2120 mm

No. of bays	Item no.	Melamine EUR	Painted EUR	Veneer EUR
1	BBN2223760110060.	-	-	-
2	BBN2223760210060.	-	-	-
3	BBN2223760310060.	-	-	-

LINGO ROUND SHELVING SYSTEM

18° - STEEL BACK FRAME - ADJUSTABLE FEET - WITH TOP PLATE - INTERMEDIATE SECTION

Painted and veneered Lingo Shelving Systems are FSC-certified.

H720 mm

No. of bays	Item no.	Melamine EUR	Painted EUR	Veneer EUR
1	BBN2224260110060.	-	-	-
2	BBN2224260210060.	-	-	-
3	BBN2224260310060.	-	-	-

H920 mm

No. of bays	Item no.	Melamine EUR	Painted EUR	Veneer EUR
1	BBN2224360110060.	-	-	-
2	BBN2224360210060.	-	-	-
3	BBN2224360310060.	-	-	-

H1220 mm

No. of bays	Item no.	Melamine EUR	Painted EUR	Veneer EUR
1	BBN2224460110060.	-	-	-
2	BBN2224460210060.	-	-	-
3	BBN2224460310060.	-	-	-

H1520 mm

No. of bays	Item no.	Melamine EUR	Painted EUR	Veneer EUR
1	BBN2224560110060.	-	-	-
2	BBN2224560210060.	-	-	-
3	BBN2224560310060.	-	-	-

H1820 mm

No. of bays	Item no.	Melamine EUR	Painted EUR	Veneer EUR
1	BBN2224660110060.	-	-	-
2	BBN2224660210060.	-	-	-
3	BBN2224660310060.	-	-	-

H2120 mm

No. of bays	Item no.	Melamine EUR	Painted EUR	Veneer EUR
1	BBN2224760110060.	-	-	-
2	BBN2224760210060.	-	-	-
3	BBN2224760310060.	-	-	-

LINGO ROUND SHELVING SYSTEM

18° - STEEL BACK FRAME - ADJUSTABLE FEET - WITH TOP PLATE - LEFT END SECTION

Painted and veneered Lingo Shelving Systems are FSC-certified.

H720 mm

No. of bays	Item no.	Melamine EUR	Painted EUR	Veneer EUR
1	BBN2225260110060.	-	-	-
2	BBN2225260210060.	-	-	-
3	BBN2225260310060.	-	-	-

H920 mm

No. of bays	Item no.	Melamine EUR	Painted EUR	Veneer EUR
1	BBN2225360110060.	-	-	-
2	BBN2225360210060.	-	-	-
3	BBN2225360310060.	-	-	-

H1220 mm

No. of bays	Item no.	Melamine EUR	Painted EUR	Veneer EUR
1	BBN2225460110060.	-	-	-
2	BBN2225460210060.	-	-	-
3	BBN2225460310060.	-	-	-

H1520 mm

No. of bays	Item no.	Melamine EUR	Painted EUR	Veneer EUR
1	BBN2225560110060.	-	-	-
2	BBN2225560210060.	-	-	-
3	BBN2225560310060.	-	-	-

H1820 mm

No. of bays	Item no.	Melamine EUR	Painted EUR	Veneer EUR
1	BBN2225660110060.	-	-	-
2	BBN2225660210060.	-	-	-
3	BBN2225660310060.	-	-	-

H2120 mm

No. of bays	Item no.	Melamine EUR	Painted EUR	Veneer EUR
1	BBN2225760110060.	-	-	-
2	BBN2225760210060.	-	-	-
3	BBN2225760310060.	-	-	-

LINGO ROUND SHELVING SYSTEM

18° - STEEL BACK FRAME - ADJUSTABLE FEET - WITH TOP PLATE - RIGHT END SECTION

Painted and veneered Lingo Shelving Systems are FSC-certified.

H720 mm

No. of bays	Item no.	Melamine EUR	Painted EUR	Veneer EUR
1	BBN2226260110060.	-	-	-
2	BBN2226260210060.	-	-	-
3	BBN2226260310060.	-	-	-

H920 mm

No. of bays	Item no.	Melamine EUR	Painted EUR	Veneer EUR
1	BBN2226360110060.	-	-	-
2	BBN2226360210060.	-	-	-
3	BBN2226360310060.	-	-	-

H1220 mm

No. of bays	Item no.	Melamine EUR	Painted EUR	Veneer EUR
1	BBN2226460110060.	-	-	-
2	BBN2226460210060.	-	-	-
3	BBN2226460310060.	-	-	-

H1520 mm

No. of bays	Item no.	Melamine EUR	Painted EUR	Veneer EUR
1	BBN2226560110060.	-	-	-
2	BBN2226560210060.	-	-	-
3	BBN2226560310060.	-	-	-

H1820 mm

No. of bays	Item no.	Melamine EUR	Painted EUR	Veneer EUR
1	BBN2226660110060.	-	-	-
2	BBN2226660210060.	-	-	-
3	BBN2226660310060.	-	-	-

H2120 mm

No. of bays	Item no.	Melamine EUR	Painted EUR	Veneer EUR
1	BBN2226760110060.	-	-	-
2	BBN2226760210060.	-	-	-
3	BBN2226760310060.	-	-	-

LINGO ROUND SHELVING SYSTEM

BBN222 - 18° - STEEL BACK PANEL - ADJUSTABLE FEET - WITH TOP PLATE



LINGO ROUND SHELVING SYSTEM

BBN222 - 18° - STEEL BACK PANEL - ADJUSTABLE FEET - WITH TOP PLATE

Round shelving system with wooden end panels, intermediate panels, steel back panel and overlaying top plate.
See further description on starter, intermediate and end sections on pages 26-27.

- Prices based on steel price group 1 and wooden price group A (see Design Options pages 6-9).
- For shelves, see from page 328
- For castor frame, see page 347

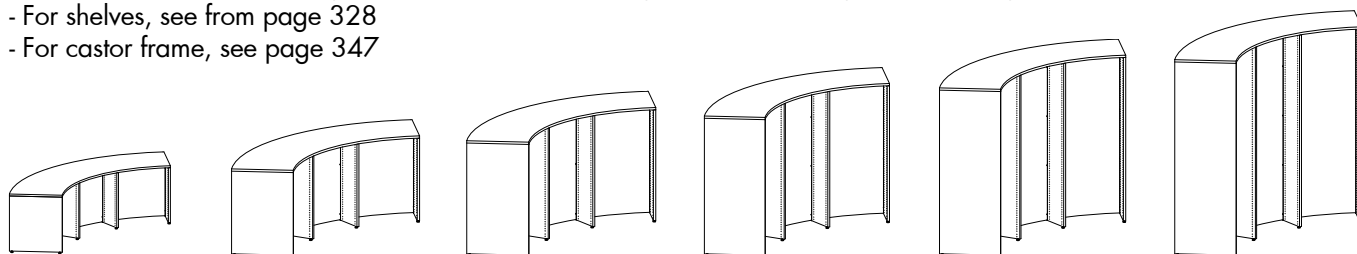

Freestanding 26° double-sided bays - H720/920/1220/1520/1820/2120 mm

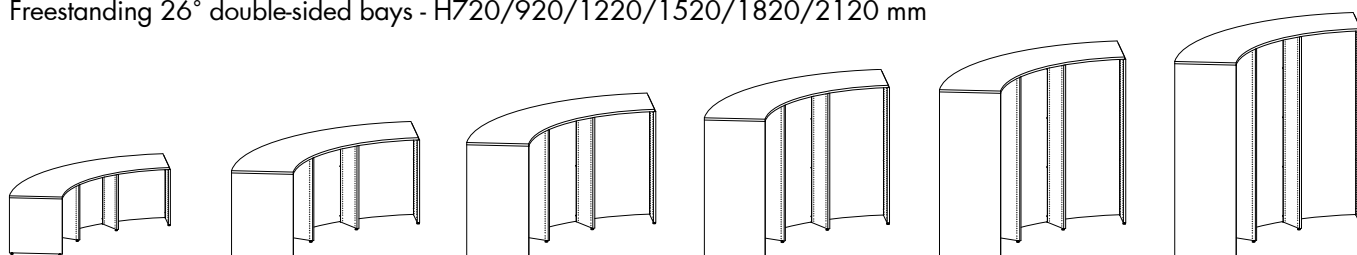

Left starter 26° double-sided bays - H720/920/1220/1520/1820/2120 mm

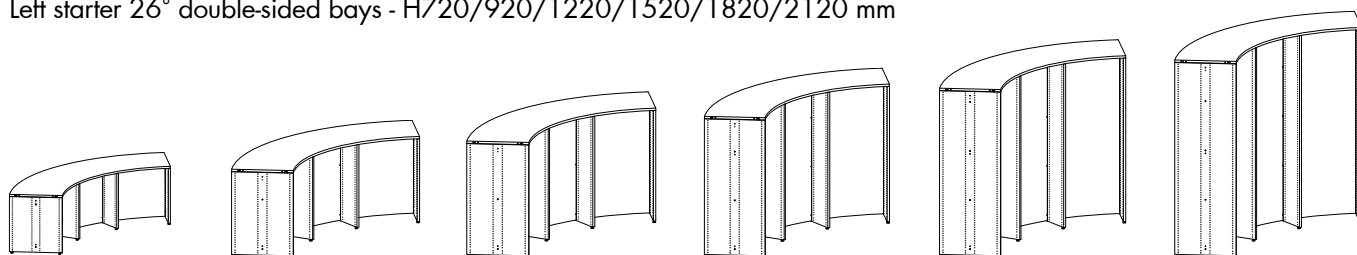

Right starter 26° double-sided bays - H720/920/1220/1520/1820/2120 mm

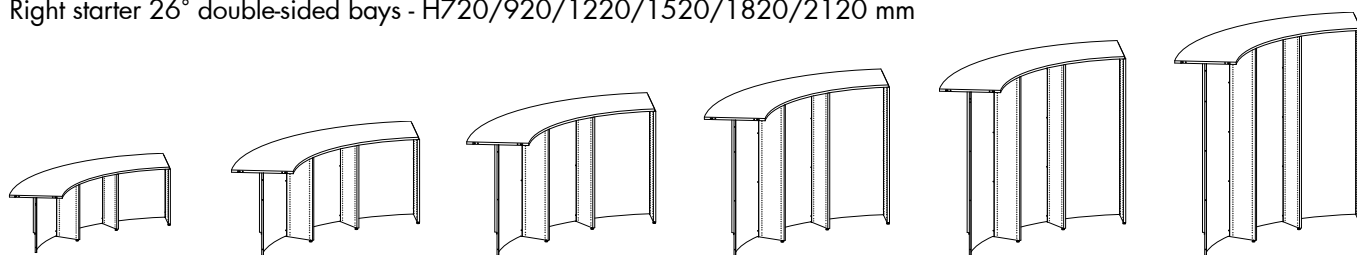

Intermediate 18° double-sided bays - H720/920/1220/1520/1820/2120 mm

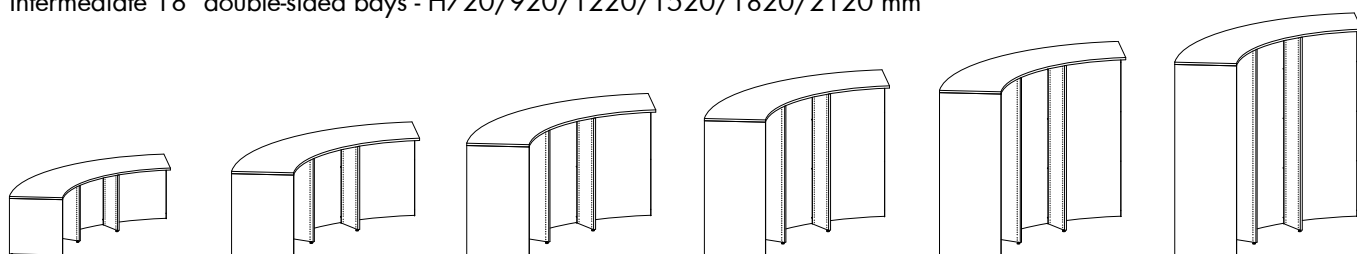

Left end 26° double-sided bays - H720/920/1220/1520/1820/2120 mm

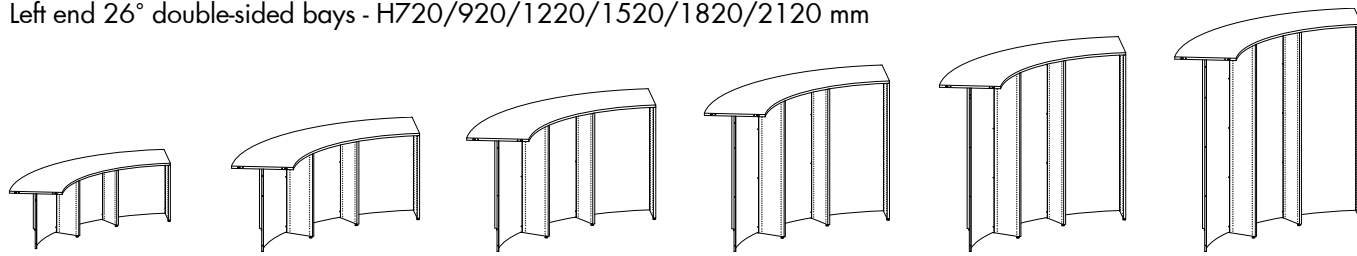

Right end 26° double-sided bays - H720/920/1220/1520/1820/2120 mm

LINGO ROUND SHELVING SYSTEM

18° - STEEL BACK PANEL - ADJUSTABLE FEET - WITH TOP PLATE - FREESTANDING SECTION

Painted and veneered Lingo Shelving Systems are FSC-certified.

H720 mm

No. of bays	Item no.	Melamine EUR	Painted EUR	Veneer EUR
1	BBN2221260110080.	-	-	-
2	BBN2221260210080.	-	-	-
3	BBN2221260310080.	-	-	-

H920 mm

No. of bays	Item no.	Melamine EUR	Painted EUR	Veneer EUR
1	BBN2221360110080.	-	-	-
2	BBN2221360210080.	-	-	-
3	BBN2221360310080.	-	-	-

H1220 mm

No. of bays	Item no.	Melamine EUR	Painted EUR	Veneer EUR
1	BBN2221460110080.	-	-	-
2	BBN2221460210080.	-	-	-
3	BBN2221460310080.	-	-	-

H1520 mm

No. of bays	Item no.	Melamine EUR	Painted EUR	Veneer EUR
1	BBN2221560110080.	-	-	-
2	BBN2221560210080.	-	-	-
3	BBN2221560310080.	-	-	-

H1820 mm

No. of bays	Item no.	Melamine EUR	Painted EUR	Veneer EUR
1	BBN2221660110080.	-	-	-
2	BBN2221660210080.	-	-	-
3	BBN2221660310080.	-	-	-

H2120 mm

No. of bays	Item no.	Melamine EUR	Painted EUR	Veneer EUR
1	BBN2221760110080.	-	-	-
2	BBN2221760210080.	-	-	-
3	BBN2221760310080.	-	-	-

LINGO ROUND SHELVING SYSTEM

18° - STEEL BACK PANEL - ADJUSTABLE FEET - WITH TOP PLATE - LEFT STARTER SECTION

Painted and veneered Lingo Shelving Systems are FSC-certified.

H720 mm

No. of bays	Item no.	Melamine EUR	Painted EUR	Veneer EUR
1	BBN2222260110080.	-	-	-
2	BBN2222260210080.	-	-	-
3	BBN2222260310080.	-	-	-

H920 mm

No. of bays	Item no.	Melamine EUR	Painted EUR	Veneer EUR
1	BBN2222360110080.	-	-	-
2	BBN2222360210080.	-	-	-
3	BBN2222360310080.	-	-	-

H1220 mm

No. of bays	Item no.	Melamine EUR	Painted EUR	Veneer EUR
1	BBN2222460110080.	-	-	-
2	BBN2222460210080.	-	-	-
3	BBN2222460310080.	-	-	-

H1520 mm

No. of bays	Item no.	Melamine EUR	Painted EUR	Veneer EUR
1	BBN2222560110080.	-	-	-
2	BBN2222560210080.	-	-	-
3	BBN2222560310080.	-	-	-

H1820 mm

No. of bays	Item no.	Melamine EUR	Painted EUR	Veneer EUR
1	BBN2222660110080.	-	-	-
2	BBN2222660210080.	-	-	-
3	BBN2222660310080.	-	-	-

H2120 mm

No. of bays	Item no.	Melamine EUR	Painted EUR	Veneer EUR
1	BBN2222760110080.	-	-	-
2	BBN2222760210080.	-	-	-
3	BBN2222760310080.	-	-	-

LINGO ROUND SHELVING SYSTEM

18° - STEEL BACK PANEL - ADJUSTABLE FEET - WITH TOP PLATE - RIGHT STARTER SECTION

Painted and veneered Lingo Shelving Systems are FSC-certified.

H720 mm

No. of bays	Item no.	Melamine EUR	Painted EUR	Veneer EUR
1	BBN2223260110080.	-	-	-
2	BBN2223260210080.	-	-	-
3	BBN2223260310080.	-	-	-

H920 mm

No. of bays	Item no.	Melamine EUR	Painted EUR	Veneer EUR
1	BBN2223360110080.	-	-	-
2	BBN2223360210080.	-	-	-
3	BBN2223360310080.	-	-	-

H1220 mm

No. of bays	Item no.	Melamine EUR	Painted EUR	Veneer EUR
1	BBN2223460110080.	-	-	-
2	BBN2223460210080.	-	-	-
3	BBN2223460310080.	-	-	-

H1520 mm

No. of bays	Item no.	Melamine EUR	Painted EUR	Veneer EUR
1	BBN2223560110080.	-	-	-
2	BBN2223560210080.	-	-	-
3	BBN2223560310080.	-	-	-

H1820 mm

No. of bays	Item no.	Melamine EUR	Painted EUR	Veneer EUR
1	BBN2223660110080.	-	-	-
2	BBN2223660210080.	-	-	-
3	BBN2223660310080.	-	-	-

H2120 mm

No. of bays	Item no.	Melamine EUR	Painted EUR	Veneer EUR
1	BBN2223760110080.	-	-	-
2	BBN2223760210080.	-	-	-
3	BBN2223760310080.	-	-	-

LINGO ROUND SHELVING SYSTEM

18° - STEEL BACK PANEL - ADJUSTABLE FEET - WITH TOP PLATE - INTERMEDIATE SECTION

Painted and veneered Lingo Shelving Systems are FSC-certified.

H720 mm

No. of bays	Item no.	Melamine EUR	Painted EUR	Veneer EUR
1	BBN2224260110080.	-	-	-
2	BBN2224260210080.	-	-	-
3	BBN2224260310080.	-	-	-

H920 mm

No. of bays	Item no.	Melamine EUR	Painted EUR	Veneer EUR
1	BBN2224360110080.	-	-	-
2	BBN2224360210080.	-	-	-
3	BBN2224360310080.	-	-	-

H1220 mm

No. of bays	Item no.	Melamine EUR	Painted EUR	Veneer EUR
1	BBN2224460110080.	-	-	-
2	BBN2224460210080.	-	-	-
3	BBN2224460310080.	-	-	-

H1520 mm

No. of bays	Item no.	Melamine EUR	Painted EUR	Veneer EUR
1	BBN2224560110080.	-	-	-
2	BBN2224560210080.	-	-	-
3	BBN2224560310080.	-	-	-

H1820 mm

No. of bays	Item no.	Melamine EUR	Painted EUR	Veneer EUR
1	BBN2224660110080.	-	-	-
2	BBN2224660210080.	-	-	-
3	BBN2224660310080.	-	-	-

H2120 mm

No. of bays	Item no.	Melamine EUR	Painted EUR	Veneer EUR
1	BBN2224760110080.	-	-	-
2	BBN2224760210080.	-	-	-
3	BBN2224760310080.	-	-	-

LINGO ROUND SHELVING SYSTEM

18° - STEEL BACK PANEL - ADJUSTABLE FEET - WITH TOP PLATE - LEFT END SECTION

Painted and veneered Lingo Shelving Systems are FSC-certified.

H720 mm

No. of bays	Item no.	Melamine EUR	Painted EUR	Veneer EUR
1	BBN2225260110080.	-	-	-
2	BBN2225260210080.	-	-	-
3	BBN2225260310080.	-	-	-

H920 mm

No. of bays	Item no.	Melamine EUR	Painted EUR	Veneer EUR
1	BBN2225360110080.	-	-	-
2	BBN2225360210080.	-	-	-
3	BBN2225360310080.	-	-	-

H1220 mm

No. of bays	Item no.	Melamine EUR	Painted EUR	Veneer EUR
1	BBN2225460110080.	-	-	-
2	BBN2225460210080.	-	-	-
3	BBN2225460310080.	-	-	-

H1520 mm

No. of bays	Item no.	Melamine EUR	Painted EUR	Veneer EUR
1	BBN2225560110080.	-	-	-
2	BBN2225560210080.	-	-	-
3	BBN2225560310080.	-	-	-

H1820 mm

No. of bays	Item no.	Melamine EUR	Painted EUR	Veneer EUR
1	BBN2225660110080.	-	-	-
2	BBN2225660210080.	-	-	-
3	BBN2225660310080.	-	-	-

H2120 mm

No. of bays	Item no.	Melamine EUR	Painted EUR	Veneer EUR
1	BBN2225760110080.	-	-	-
2	BBN2225760210080.	-	-	-
3	BBN2225760310080.	-	-	-

LINGO ROUND SHELVING SYSTEM

18° - STEEL BACK PANEL - ADJUSTABLE FEET - WITH TOP PLATE - RIGHT END SECTION

Painted and veneered Lingo Shelving Systems are FSC-certified.

H720 mm

No. of bays	Item no.	Melamine EUR	Painted EUR	Veneer EUR
1	BBN2226260110080.	-	-	-
2	BBN2226260210080.	-	-	-
3	BBN2226260310080.	-	-	-

H920 mm

No. of bays	Item no.	Melamine EUR	Painted EUR	Veneer EUR
1	BBN2226360110080.	-	-	-
2	BBN2226360210080.	-	-	-
3	BBN2226360310080.	-	-	-

H1220 mm

No. of bays	Item no.	Melamine EUR	Painted EUR	Veneer EUR
1	BBN2226460110080.	-	-	-
2	BBN2226460210080.	-	-	-
3	BBN2226460310080.	-	-	-

H1520 mm

No. of bays	Item no.	Melamine EUR	Painted EUR	Veneer EUR
1	BBN2226560110080.	-	-	-
2	BBN2226560210080.	-	-	-
3	BBN2226560310080.	-	-	-

H1820 mm

No. of bays	Item no.	Melamine EUR	Painted EUR	Veneer EUR
1	BBN2226660110080.	-	-	-
2	BBN2226660210080.	-	-	-
3	BBN2226660310080.	-	-	-

H2120 mm

No. of bays	Item no.	Melamine EUR	Painted EUR	Veneer EUR
1	BBN2226760110080.	-	-	-
2	BBN2226760210080.	-	-	-
3	BBN2226760310080.	-	-	-

LINGO ROUND SHELVING SYSTEM

BBN231 - 18° - STEEL BACK FRAME - CASTOR PLATE - FOR TOP SHELF



LINGO ROUND SHELVING SYSTEM

BBN231 - 18° - STEEL BACK FRAME - CASTOR PLATE - FOR TOP SHELF

Round shelving system with wooden panels, steel back frame and castor plate. To be used with top shelf.

- Prices based on steel price group 1 and wooden price group A (see Design Options pages 6-9).
- For top shelves, see from page 340
- For shelves, see from page 328

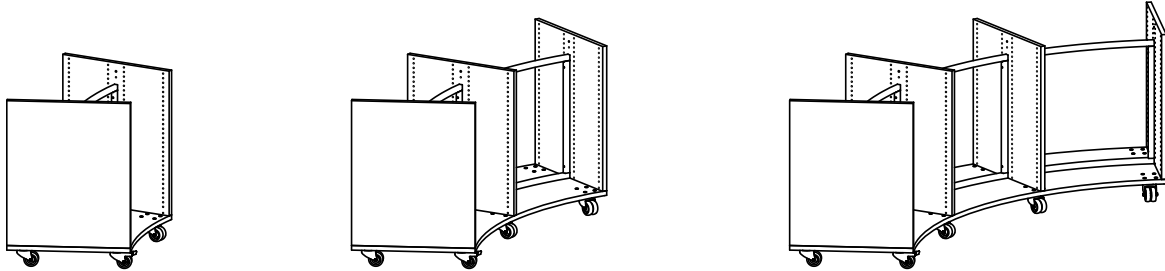

Double-sided H920 mm - 1/2/3 bays

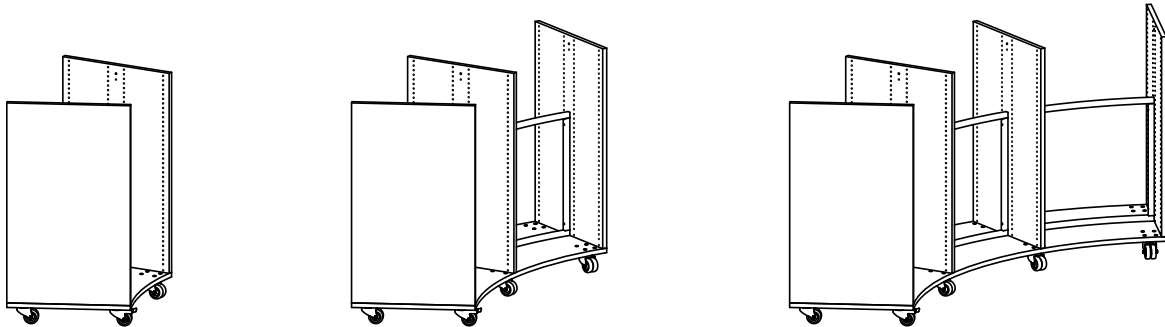

Double-sided H1220 mm - 1/2/3 bays

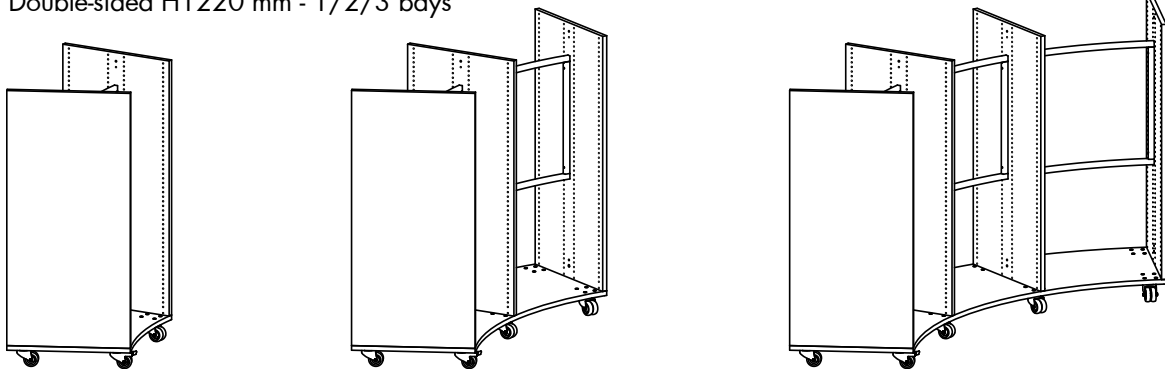

Double-sided H1520 mm - 1/2/3 bays

LINGO ROUND SHELVING SYSTEM

18° - STEEL BACK FRAME - CASTOR PLATE - FOR TOP SHELF

Painted and veneered Lingo Shelving Systems are FSC-certified.

H920 mm

No. of bays	Item no.	Melamine EUR	Painted EUR	Veneer EUR
1	BBN231136010006.	-	-	-
2	BBN231136020006.	-	-	-
3	BBN231136030006.	-	-	-

H1220 mm

No. of bays	Item no.	Melamine EUR	Painted EUR	Veneer EUR
1	BBN231146010006.	-	-	-
2	BBN231146020006.	-	-	-
3	BBN231146030006.	-	-	-

H1520 mm

No. of bays	Item no.	Melamine EUR	Painted EUR	Veneer EUR
1	BBN231156010006.	-	-	-
2	BBN231156020006.	-	-	-
3	BBN231156030006.	-	-	-

LINGO ROUND SHELVING SYSTEM

18° - STEEL BACK FRAME - CASTOR PLATE - FOR TOP SHELF

LINGO ROUND SHELVING SYSTEM

BBN231 - 18° - HIGH STEEL BACK PANEL - CASTOR PLATE - FOR TOP SHELF



LINGO ROUND SHELVING SYSTEM

BBN231 - 18° - HIGH STEEL BACK PANEL - CASTOR PLATE - FOR TOP SHELF

Round shelving system with wooden panels, high steel back panel and castor plate.
To be used with top shelves WT5 standard depth top shelf.

- Prices based on steel price group 1 and wooden price group A (see Design Options pages 6-9).
- For top shelves, see from page 340
- For shelves, see from page 328

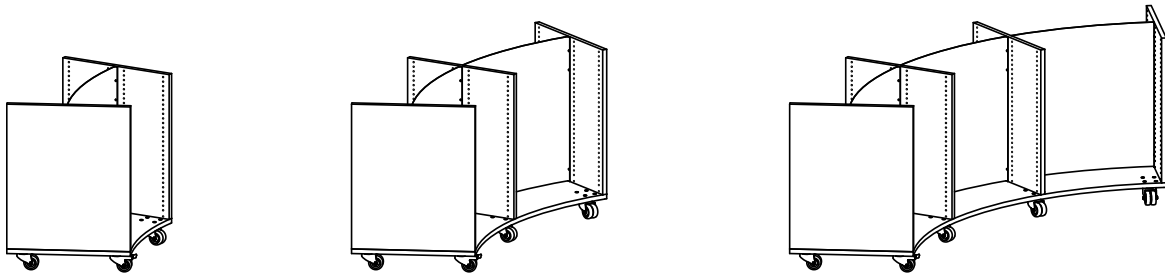

Double-sided H920 mm - 1/2/3 bays

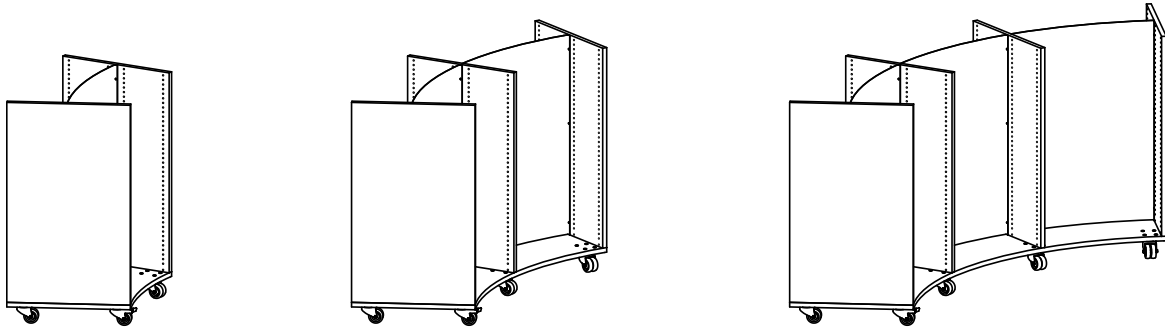

Double-sided H1220 mm - 1/2/3 bays

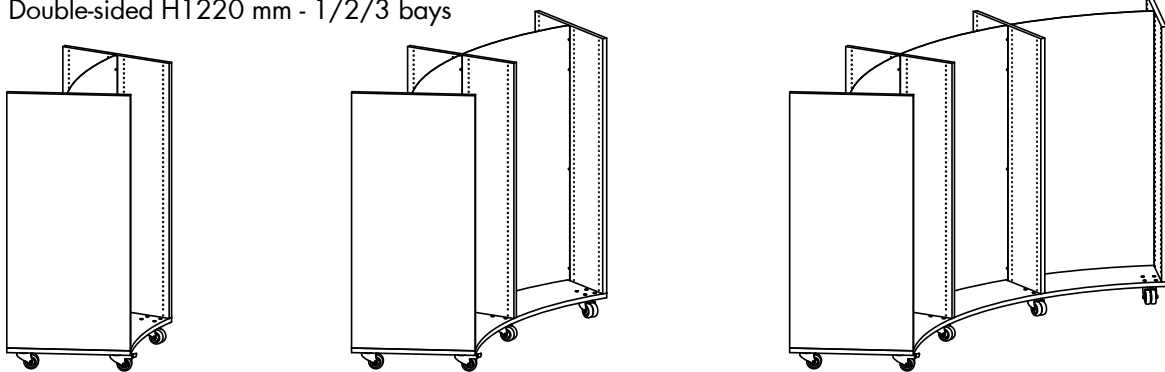

Double-sided H1520 mm - 1/2/3 bays

LINGO ROUND SHELVING SYSTEM

18° - HIGH STEEL BACK PANEL - CASTOR PLATE - FOR TOP SHELF

Painted and veneered Lingo Shelving Systems are FSC-certified.

H920 mm

No. of bays	Item no.	Melamine EUR	Painted EUR	Veneer EUR
1	BBN231136010008.	-	-	-
2	BBN231136020008.	-	-	-
3	BBN231136030008.	-	-	-

H1220 mm

No. of bays	Item no.	Melamine EUR	Painted EUR	Veneer EUR
1	BBN231146010008.	-	-	-
2	BBN231146020008.	-	-	-
3	BBN231146030008.	-	-	-

H1520 mm

No. of bays	Item no.	Melamine EUR	Painted EUR	Veneer EUR
1	BBN231156010008.	-	-	-
2	BBN231156020008.	-	-	-
3	BBN231156030008.	-	-	-

LINGO ROUND SHELVING SYSTEM

18° - HIGH STEEL BACK PANEL - CASTOR PLATE - FOR TOP SHELF

LINGO ROUND SHELVING SYSTEM

BBN231 - 18° - LOW STEEL BACK PANEL - CASTOR PLATE - FOR TOP SHELF



LINGO ROUND SHELVING SYSTEM

BBN231 - 18° - LOW STEEL BACK PANEL - CASTOR PLATE - FOR TOP SHELF

Round shelving system with wooden panels, low steel back panel and castor plate.
To be used with top shelves WT5 full depth and WT5 double-sided top shelf.

- Prices based on steel price group 1 and wooden price group A (see Design Options pages 6-9).
- For top shelves, see from page 340
- For shelves, see from page 328
- For slat panels, see from page 351 (note slate panel replaces outer panel)

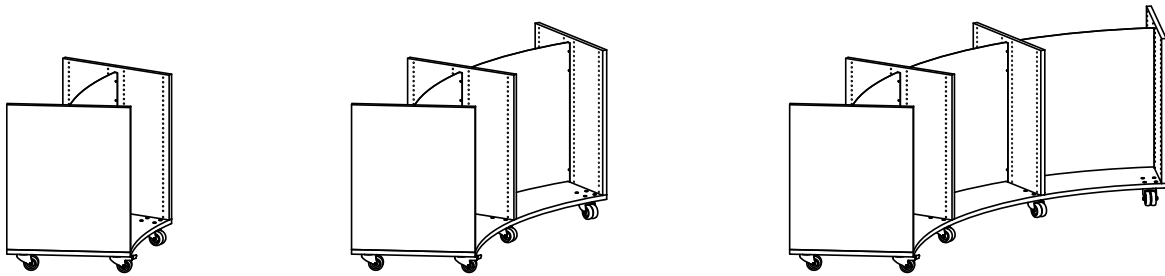

Double-sided H920 mm - 1/2/3 bays

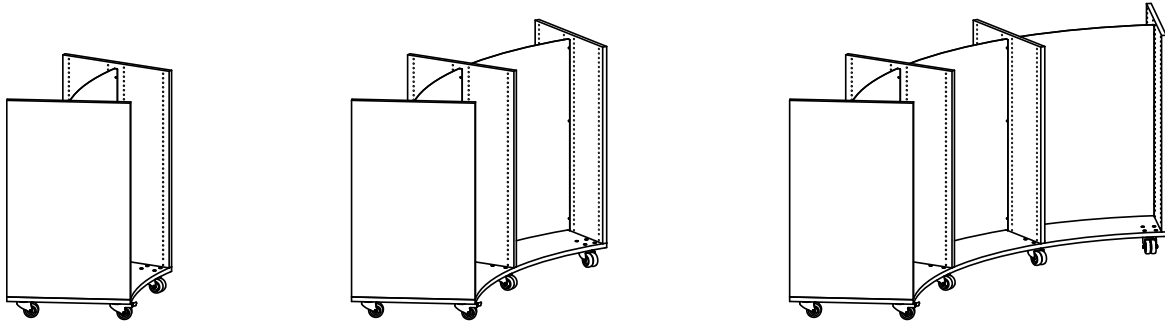

Double-sided H1220 mm - 1/2/3 bays

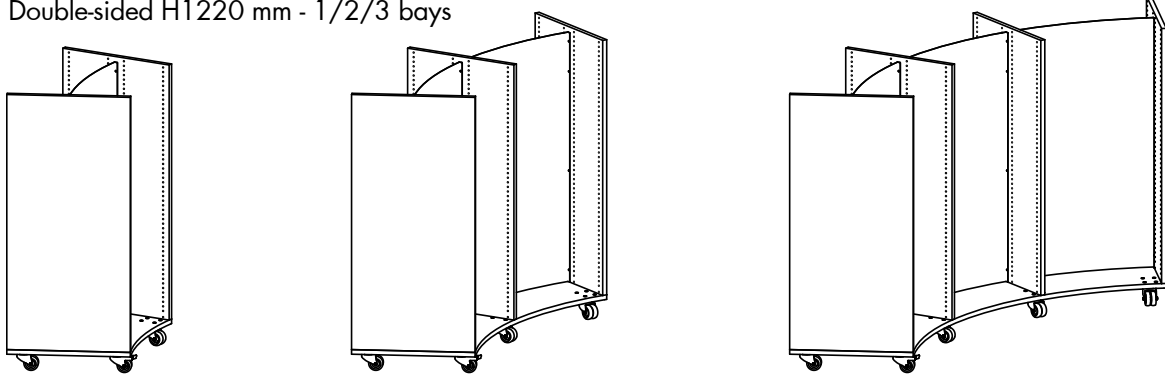

Double-sided H1520 mm - 1/2/3 bays

LINGO ROUND SHELVING SYSTEM

18° - LOW STEEL BACK PANEL - CASTOR PLATE - FOR TOP SHELF

Painted and veneered Lingo Shelving Systems are FSC-certified.

H920 mm

No. of bays	Item no.	Melamine EUR	Painted EUR	Veneer EUR
1	BBN231136010007.	-	-	-
2	BBN231136020007.	-	-	-
3	BBN231136030007.	-	-	-

H1220 mm

No. of bays	Item no.	Melamine EUR	Painted EUR	Veneer EUR
1	BBN231146010007.	-	-	-
2	BBN231146020007.	-	-	-
3	BBN231146030007.	-	-	-

H1520 mm

No. of bays	Item no.	Melamine EUR	Painted EUR	Veneer EUR
1	BBN231156010007.	-	-	-
2	BBN231156020007.	-	-	-
3	BBN231156030007.	-	-	-

LINGO ROUND SHELVING SYSTEM

18° - LOW STEEL BACK PANEL - CASTOR PLATE - FOR TOP SHELF

LINGO ROUND SHELVING SYSTEM

BBN232 - 18° - STEEL BACK FRAME - CASTOR PLATE - WITH OVERLAYING TOP PLATE



LINGO ROUND SHELVING SYSTEM

BBN232 - 18° - STEEL BACK FRAME - CASTOR PLATE - WITH OVERLAYING TOP PLATE

Round shelving system with wooden panels, steel back frame, castor plate and overlaying top plate.

- Prices based on steel price group 1 and wooden price group A (see Design Options pages 6-9).
- For shelves, see from page 328

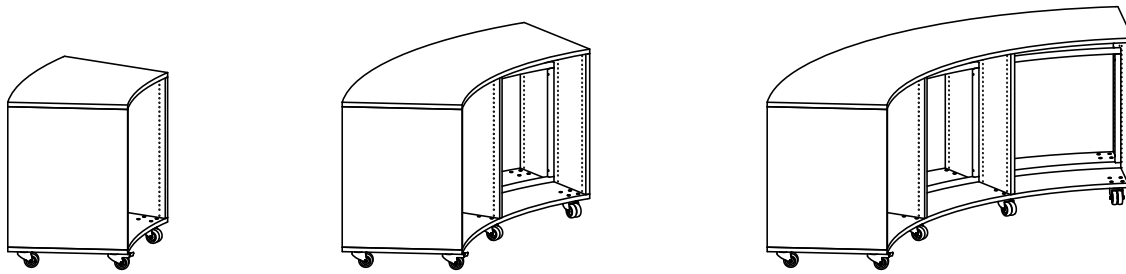

Double-sided H920 mm - 1/2/3 bays

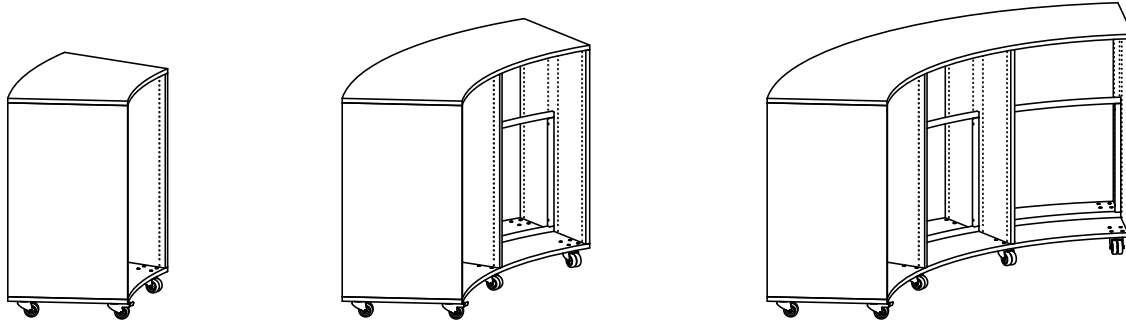

Double-sided H1220 mm - 1/2/3 bays

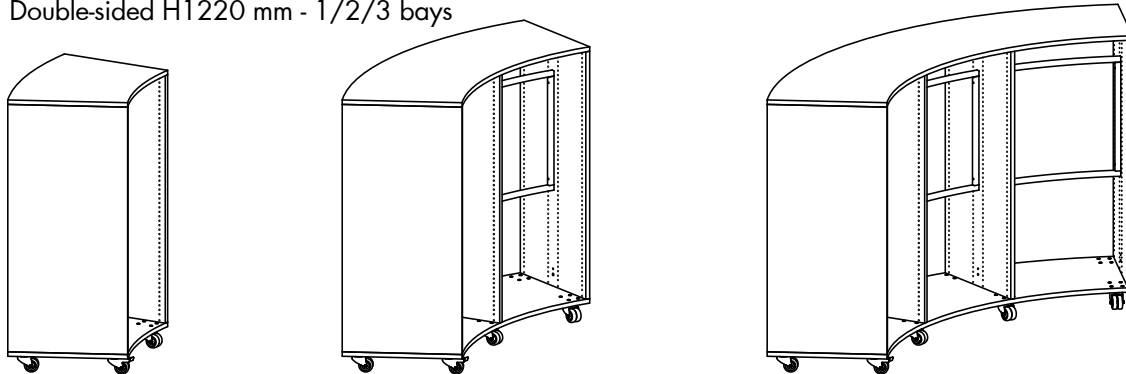

Double-sided H1520 mm - 1/2/3 bays

LINGO ROUND SHELVING SYSTEM

18° - STEEL BACK FRAME - CASTOR PLATE - WITH OVERLAYING TOP PLATE

Painted and veneered Lingo Shelving Systems are FSC-certified.

H920 mm

No. of bays	Item no.	Melamine EUR	Painted EUR	Veneer EUR
1	BBN232136011006.	-	-	-
2	BBN232136021006.	-	-	-
3	BBN232136031006.	-	-	-

H1220 mm

No. of bays	Item no.	Melamine EUR	Painted EUR	Veneer EUR
1	BBN232146011006.	-	-	-
2	BBN232146021006.	-	-	-
3	BBN232146031006.	-	-	-

H1520 mm

No. of bays	Item no.	Melamine EUR	Painted EUR	Veneer EUR
1	BBN232156011006.	-	-	-
2	BBN232156021006.	-	-	-
3	BBN232156031006.	-	-	-

LINGO ROUND SHELVING SYSTEM

18° - STEEL BACK FRAME - CASTOR PLATE - WITH OVERLAYING TOP PLATE

LINGO ROUND SHELVING SYSTEM

BBN232 - 18° - STEEL BACK PANEL - CASTOR PLATE - WITH OVERLAYING TOP PLATE



LINGO ROUND SHELVING SYSTEM

BBN232 - 18° - STEEL BACK PANEL - CASTOR PLATE - WITH OVERLAYING TOP PLATE

Round shelving system with wooden panels, steel back panel, castor plate and overlaying top plate.

- Prices based on steel price group 1 and wooden price group A (see Design Options pages 6-9).
- For shelves, see from page 328

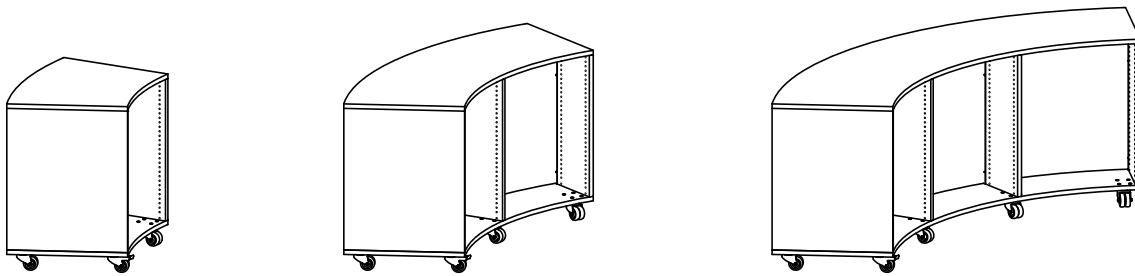

Double-sided H920 mm - 1/2/3 bays

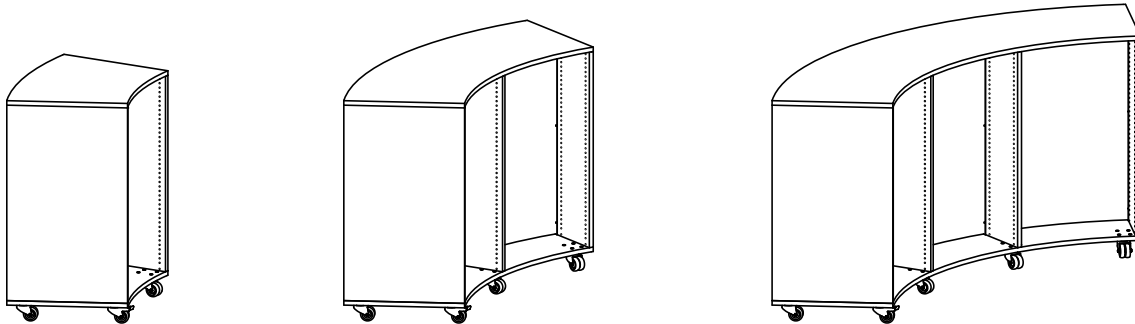

Double-sided H1220 mm - 1/2/3 bays

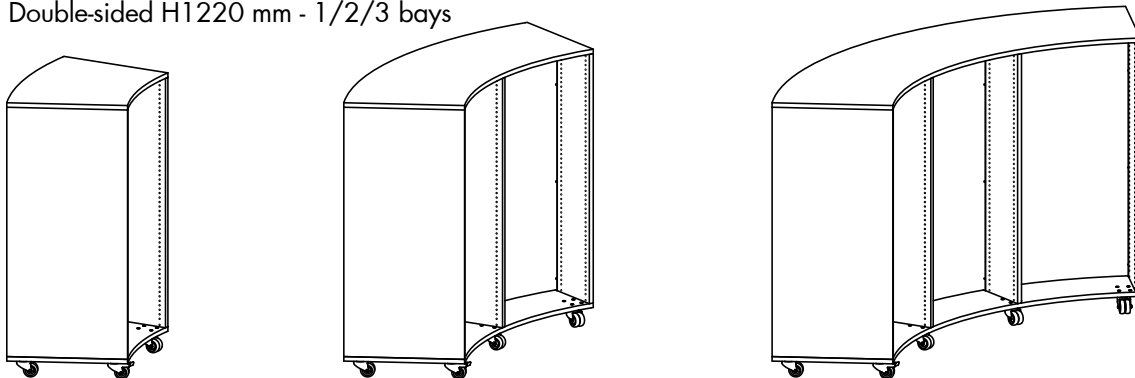

Double-sided H1520 mm - 1/2/3 bays

LINGO ROUND SHELVING SYSTEM

18° - STEEL BACK PANEL - CASTOR PLATE - WITH OVERLAYING TOP PLATE

Painted and veneered Lingo Shelving Systems are FSC-certified.

H920 mm

No. of bays	Item no.	Melamine EUR	Painted EUR	Veneer EUR
1	BBN232136011008.	-	-	-
2	BBN232136021008.	-	-	-
3	BBN232136031008.	-	-	-

H1220 mm

No. of bays	Item no.	Melamine EUR	Painted EUR	Veneer EUR
1	BBN232146011008.	-	-	-
2	BBN232146021008.	-	-	-
3	BBN232146031008.	-	-	-

H1520 mm

No. of bays	Item no.	Melamine EUR	Painted EUR	Veneer EUR
1	BBN232156011008.	-	-	-
2	BBN232156021008.	-	-	-
3	BBN232156031008.	-	-	-

LINGO ROUND SHELVING SYSTEM

18° - STEEL BACK PANEL - CASTOR PLATE - WITH OVERLAYING TOP PLATE



COMPONENTS

CHECK LIST

When constructing your round shelving, there are many factors to be taken into consideration and most importantly, you must remember to order all parts. Below you will find a check list of components you need to consider when constructing your round wooden shelving.

SHELVES

The following factors are all to be considered before choosing the shelf:

- steel or wooden shelf
- steel or wooden topshelf, or wooden overlaying top plate

CASTORS

Extra components to complete the function and design of shelving:

- castor frame with castors
- castor plate with castors
- plinth

PANELS

The following factors are all to be considered before choosing the panel:

- height (720/920/1220/1520/1820/2120 mm)
- stationary or mobile (adjustable feet/castor frame/castor plate)
- top (top shelf/overlaying top plate)

CONNECTION ELEMENTS

To support the shelving and determine the design of shelving system, you must choose between one of the 2 connection elements. Note that if you wish to combine straight and round shelving and maintain the same design, you must use the steel back frame.:

- steel back frame/ steel back panel

SHELVES

S5 - ROUND STEEL SHELVES

See below for overview of standard round steel shelves:

S5 - ROUND STEEL SHELF WITH STEEL BACKEDGE

Details:

- 26°/18°
- Inner & outer
- Depth 300 mm
- Steel backedge H47 mm
- Steel brackets
- Max. weight 80 kg.

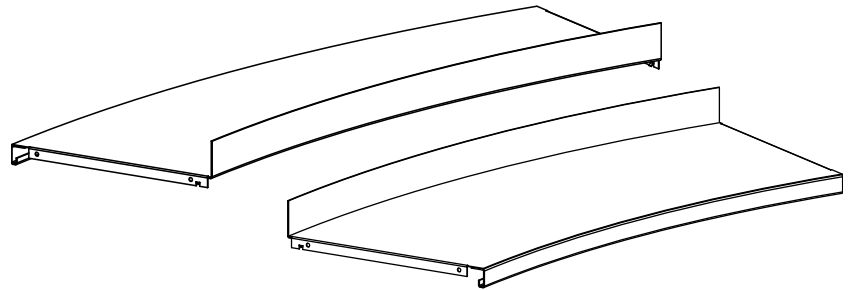

Use with:

- WT5 - wooden top shelf
- WO5 - wooden overlaying top plate

Note:

- Steel shelves placed at the bottom, must always be fixed with screws.

SHELVES

S6 - ROUND STEEL SHELVES

See below for overview of standard round steel shelves:

S6 - ROUND STEEL SHELF

Details:

- 26°/18°
- Inner & outer
- Depth 300 mm
- Steel brackets
- Max. weight 80 kg.

Use with:

- WT5 - wooden top shelf
- WO5 - wooden overlaying top plate

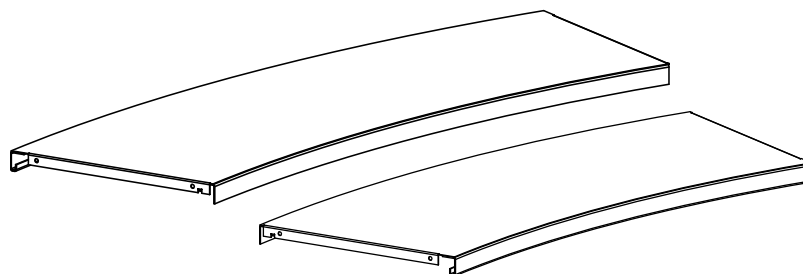

Note:

- Steel shelves placed at the bottom, must always be fixed with screws.

SHELVES

S5 - ROUND STEEL SHELF WITH STEEL BACKEDGE

S5 - intermediate, round, steel shelf with steel backedge and steel brackets - inner

Steel backedge 47 mm.
With brackets and fittings.

Degree	Shelf depth mm
26	300
18	300

Item no.

BBN290611 -
BBN290811 -

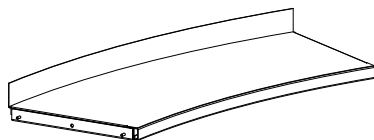

S5 - intermediate, round, steel shelf with steel backedge and steel brackets - outer

Steel backedge 47 mm.
With brackets, fittings and shelf
strengthner.

Degree	Shelf depth mm
26	300
18	300

Item no.

BBN290621 -
BBN290821 -

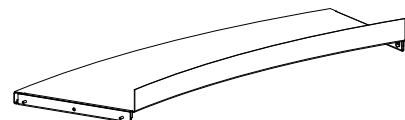

SHELVES

S5 - ROUND STEEL SHELF WITH STEEL BACKEDGE & BRACKETS

S5 - intermediate, round, steel shelf with steel backedge - inner

Steel backedge 47 mm.
Brackets to be ordered
separately, see below.

Degree	Shelf depth mm
26	300
18	300

Item no.

BN26561
BN26581

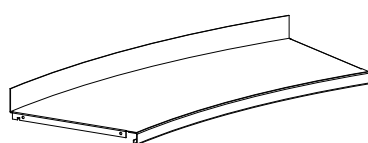

S5 - intermediate, round, steel shelf with steel backedge - outer

Steel backedge 47 mm.
With shelf strengthner.
Brackets to be ordered
separately, see below.

Degree	Shelf depth mm
26	300
18	300

Item no.

BN26562
BN26582

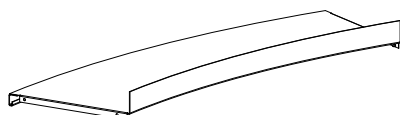

Steel bracket - for S5 & S6

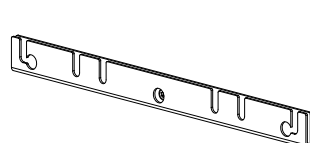

Shelf depth mm
300

Item no.

BN0843

SHELVES

S6 - ROUND STEEL SHELF

S6 - intermediate, round, steel shelf with steel brackets - inner

With brackets and fittings.	Degree	Shelf depth mm	Item no.	
	26	300	BBN290612	-
	18	300	BBN290812	-

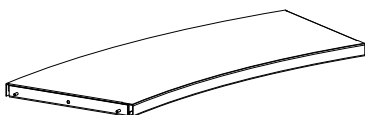

S6 - intermediate, round, steel shelf with steel brackets - outer

With brackets, fittings and shelf strengthenner.	Degree	Shelf depth mm	Item no.	
	26	300	BBN290622	-
	18	300	BBN290822	-

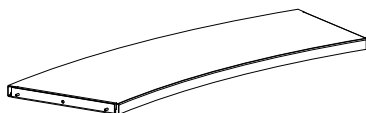

SHELVES

S6 - ROUND STEEL SHELF & BRACKETS

S6 - intermediate, round, steel shelf - inner

Brackets to be ordered separately, see below.

Degree	Shelf depth mm
26	300
18	300

Item no.

BN26661

-

BN26681

-

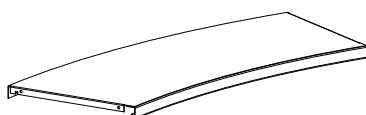

S6 - intermediate, round, steel shelf - outer

With shelf strengthner.
Brackets to be ordered separately, see below.

Degree	Shelf depth mm
26	300
18	300

Item no.

BN26662

-

BN26682

-



Steel bracket - for S5 & S6

Shelf depth mm
300

Item no.

BN0843

-

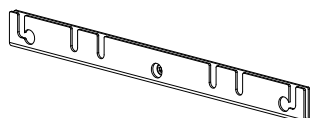

SHELVES

W5 & W6 - ROUND WOODEN SHELVES

See below for overview of standard round wooden shelves:

W5 - ROUND WOODEN SHELF WITH H47 MM STEEL BACKEDGE

Details:

- 26°/18°
- Depth 300 mm
- Painted/veneer
- Steel backedge H47 mm
- Snapfix for intermediate shelf/
snapfix and screws for bottom shelf
- Max. weight 80 kg.
- Blockboard

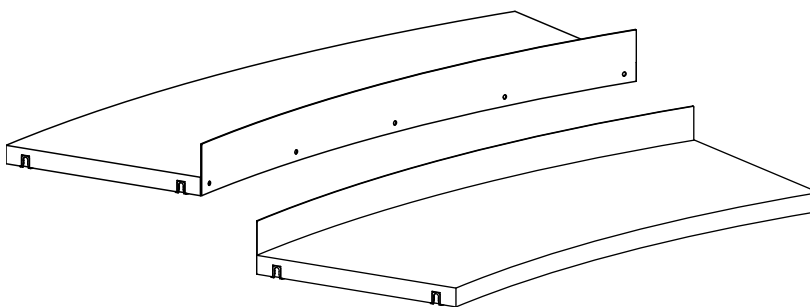

Use with:

- S6 - round steel top shelf
- WT5 - round wooden top shelf
- WO5 - round wooden overlaying top plate

Note:

- Wooden shelves placed at the bottom, must always be fixed with snapfix and screws.

W6 - ROUND WOODEN SHELF

Details:

- 26°/18°
- Depth 300 mm
- Painted/veneer
- No backedge
- Snapfix for intermediate shelf/
snapfix and screws for bottom shelf
- Max. weight 80 kg.
- Blockboard

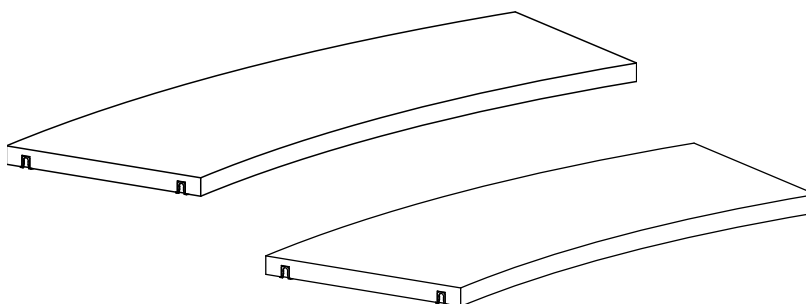

Use with:

- S6 - round steel top shelf
- WT5 - wooden top shelf
- WO5 - wooden overlaying top plate

Note:

- Wooden shelves placed at the bottom, must always be fixed with snapfix and screws.

SHELVES

W7 & W8 - ROUND WOODEN SHELVES

See below for overview of standard round wooden shelves:

W7 - ROUND WOODEN SHELF WITH H47 MM STEEL BACKEDGE

Details:

- 26°/18°
- Depth 300 mm
- Melamine
- Steel backedge H47 mm
- Snapfix for intermediate shelf/
snapfix and screws for bottom shelf
- Max. weight 60 kg.
- Particleboard

Use with:

- S6 - round steel top shelf
- WT7 - wooden top shelf
- WO5 - wooden overlaying top plate

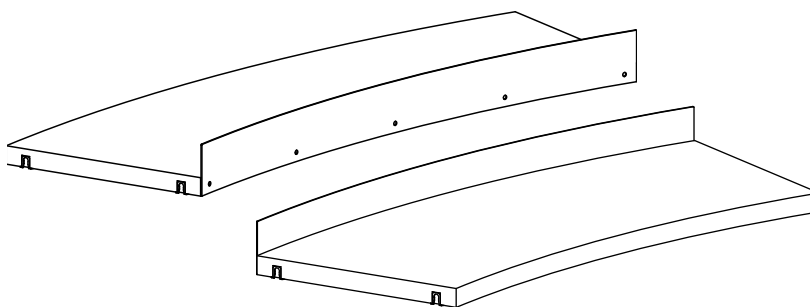

Note:

- Wooden shelves placed at the bottom, must always be fixed with snapfix and screws.

W8 - ROUND WOODEN SHELF

Details:

- 26°/18°
- Depth 300 mm
- Melamine
- No backedge
- Snapfix for intermediate shelf/
snapfix and screws for bottom shelf
- Max. weight 60 kg.
- Particleboard

Use with:

- S6 - round steel top shelf
- WT7 - wooden top shelf
- WO5 - wooden overlaying top plate

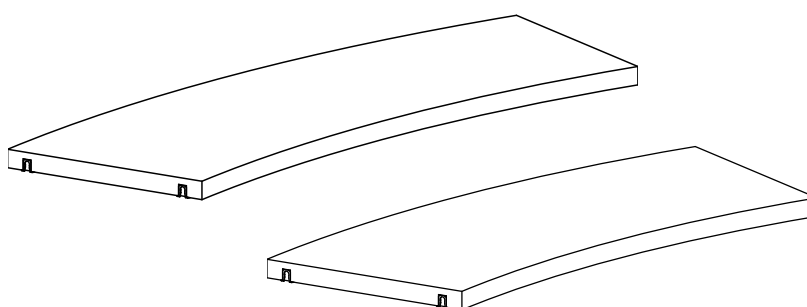

Note:

- Wooden shelves placed at the bottom, must always be fixed with snapfix and screws.

SHELVES

W5 - ROUND WOODEN SHELF WITH H47 MM BACKEDGE AND COMPONENTS

Painted and veneered shelves are FSC-certified.

W5 - intermediate, round wooden shelf with steel backedge and snapfix - inner

H47 mm steel backedge. Blockboard. Incl. fittings (snapfix).	Degree	Shelf depth mm	Item no.	Painted	Veneer
	26	300	BN267611.ZZZZZ3	-	-
	18	300	BN267811.ZZZZZ3	-	-

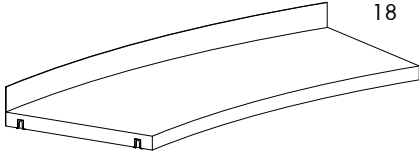

W5 - intermediate, round wooden shelf with steel backedge and snapfix - outer

H47 mm steel backedge. Blockboard. Incl. fittings (snapfix).	Degree	Shelf depth mm	Item no.	Painted	Veneer
	26	300	BN267621.ZZZZZ3	-	-
	18	300	BN267821.ZZZZZ3	-	-

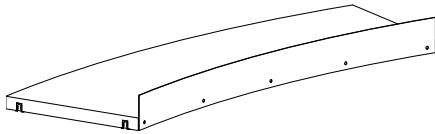

W5 - bottom, round wooden shelf with steel backedge, snapfix and screws - inner

H47 mm steel backedge. Blockboard. Incl. fittings (snapfix and screws).	Degree	Shelf depth mm	Item no.	Painted	Veneer
	26	300	BN267611.ZZZZZ2	-	-
	18	300	BN267811.ZZZZZ2	-	-

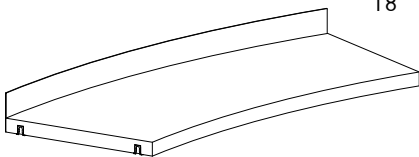

W5 - bottom, round wooden shelf with steel backedge, snapfix and screws - outer

H47 mm steel backedge. Blockboard. Incl. fittings (snapfix and screws).	Degree	Shelf depth mm	Item no.	Painted	Veneer
	26	300	BN267621.ZZZZZ2	-	-
	18	300	BN267821.ZZZZZ2	-	-

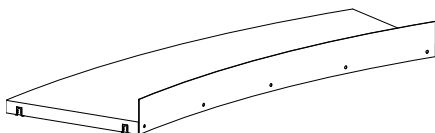

SHELVES

W6 - ROUND WOODEN SHELF AND COMPONENTS

Painted and veneered shelves are FSC-certified.

W6 - intermediate, round wooden shelf without backedge, with snapfix - inner

Blockboard. Incl. fittings (snapfix).	Degree	Shelf depth mm	Item no.	Painted	Veneer
	26	300	BN267610.ZZZZZ3	-	-
	18	300	BN267810.ZZZZZ3	-	-

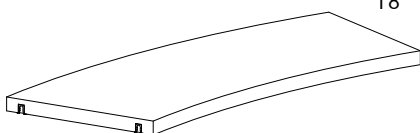

W6 - intermediate, round wooden shelf without backedge, with snapfix - outer

Blockboard. Incl. fittings (snapfix).	Degree	Shelf depth mm	Item no.	Painted	Veneer
	26	300	BN267620.ZZZZZ3	-	-
	18	300	BN267820.ZZZZZ3	-	-

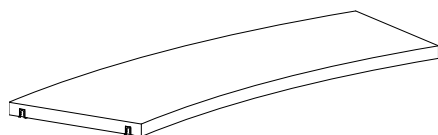

W6 - bottom, round wooden shelf without backedge, with snapfix and screws - inner

Blockboard. Incl. fittings (snapfix and screws).	Degree	Shelf depth mm	Item no.	Painted	Veneer
	26	300	BN267610.ZZZZZ2	-	-
	18	300	BN267810.ZZZZZ2	-	-

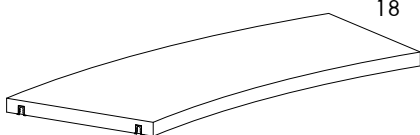

W6 - bottom, round wooden shelf without backedge, with snapfix and screws - outer

Blockboard. Incl. fittings (snapfix and screws).	Degree	Shelf depth mm	Item no.	Painted	Veneer
	26	300	BN267620.ZZZZZ2	-	-
	18	300	BN267820.ZZZZZ2	-	-

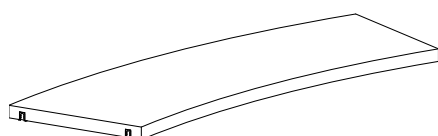

SHELVES

W7 - ROUND WOODEN SHELF WITH H47 MM BACKEDGE & COMPONENTS

W7 - intermediate, round wooden shelf with steel backedge and snapfix - inner

H47 mm steel backedge. Particleboard. Incl. fittings (snapfix)	Degree	Shelf depth mm	Item no.	Melamine
	26	300	BN270611.ZZZ3	-
	18	300	BN270811.ZZZ3	-

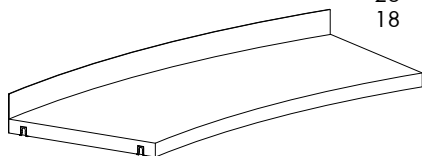

W7 - intermediate, round wooden shelf with steel backedge and snapfix - outer

H47 mm steel backedge. Particleboard. Incl. fittings (snapfix)	Degree	Shelf depth mm	Item no.	Laminate
	26	300	BN270621.ZZZ3	-
	18	300	BN270821.ZZZ3	-

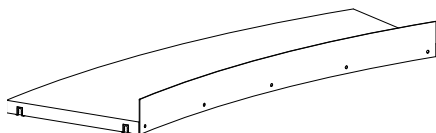

W7 - bottom, round wooden shelf with steel backedge, snapfix and screws - inner

H47 mm steel backedge. Particleboard Incl. fittings (snapfix)	Degree	Shelf depth mm	Item no.	Melamine
	26	300	BN270611.ZZZ2	-
	18	300	BN270811.ZZZ2	-

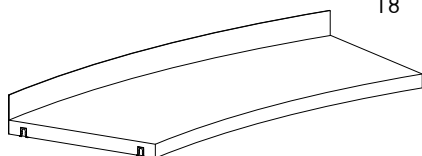

W7 - bottom, round wooden shelf with steel backedge, snapfix and screws - outer

H47 mm steel backedge. Particleboard. Incl. fittings (snapfix)	Degree	Shelf depth mm	Item no.	Laminate
	26	300	BN270621.ZZZ2	-
	18	300	BN270821.ZZZ2	-

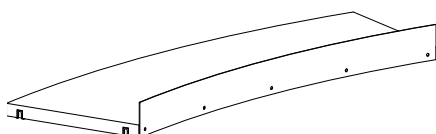

SHELVES

W8 - ROUND WOODEN SHELF

W8 - intermediate, round wooden shelf without backedge, with snapfix - inner

Particleboard. Incl. fittings (snapfix).	Degree	Shelf depth mm	Item no.	Melamine
	26	300	BN270610.ZZZ3	-
	18	300	BN270810.ZZZ3	-

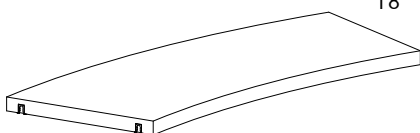

W8 - intermediate, round wooden shelf without backedge, with snapfix - outer

Particleboard. Incl. fittings (snapfix).	Degree	Shelf depth mm	Item no.	Laminate
	26	300	BN270620.ZZZ3	-
	18	300	BN270820.ZZZ3	-

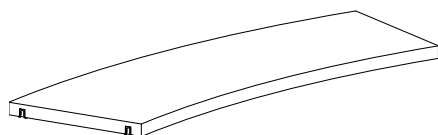

W8 - bottom, round wooden shelf without backedge, with snapfix and screws - inner

Particleboard. Incl. fittings (snapfix and screws).	Degree	Shelf depth mm	Item no.	Melamine
	26	300	BN270610.ZZZ2	-
	18	300	BN270810.ZZZ2	-

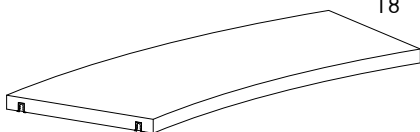

W8 - bottom, round wooden shelf without backedge, with snapfix and screws - outer

Particleboard. Incl. fittings (snapfix and screws).	Degree	Shelf depth mm	Item no.	Laminate
	26	300	BN270620.ZZZ2	-
	18	300	BN270820.ZZZ2	-

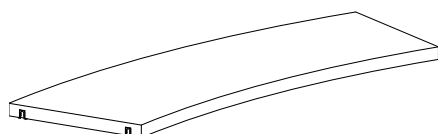

SHELVES

WT5 - ROUND WOODEN TOP SHELVES

Choose between a wooden top shelf (placed in between the wooden panels) or a wooden overlaying top plate (placed on top of the panels).

WT5 - ROUND WOODEN TOP SHELF

Details:

- 26°/18°
- Painted/veneer
- Single-sided standard depth inner & outer
Double-sided
- Snapfix and screws
- Max. weight 25 kg
- Particleboard

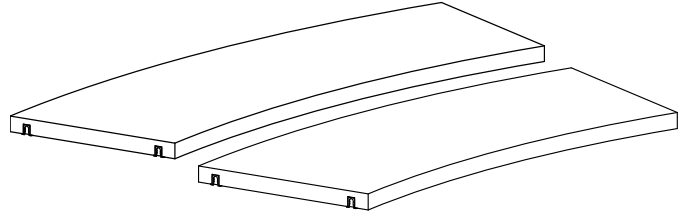

Use with:

- S5 - round steel shelves
- W5/W6/W7/W8 - round wooden shelves
- WP1/WP5 - wooden panel
- SBP5/SBP7 - round steel back panel for standard depth
SBP6/SBP8 - round steel back panel for double-sided

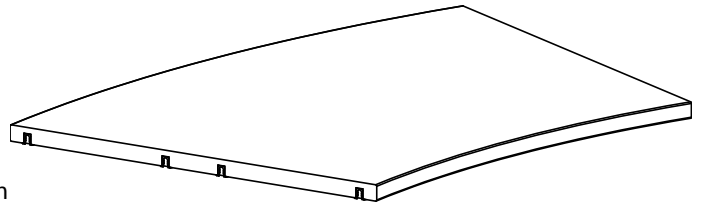

Note:

- Wooden top shelves must always be fixed with snapfix and screws.

SHELVES

WT7 - ROUND WOODEN TOP SHELVES

Choose between a wooden top shelf (placed in between the wooden panels) or a wooden overlaying top plate (placed on top of the panels).

WT7 - ROUND WOODEN TOP SHELF

Details:

- 26°/18°
- Melamine
- Single-sided standard depth inner & outer
Double-sided
- Snapfix and screws
- Max. weight 25 kg.
- Particleboard

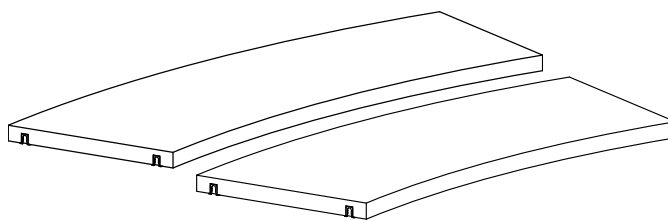

Use with:

- S5 - round steel shelves
- W5/W5/W7/W8 - round wooden shelves
- WP1/WP5 - wooden panel
- SBP5/SBP7 - round steel back panel for standard depth
SBP6/SBP8 - round steel back panel for double-sided

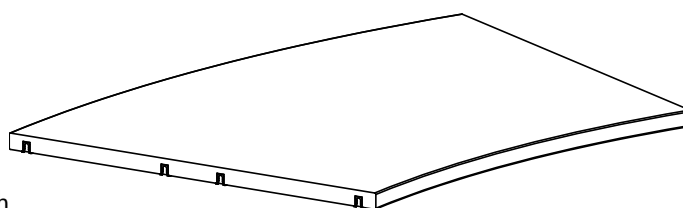

Note:

- Wooden top shelves must always be fixed with snapfix and screws.

SHELVES

WT5 - ROUND WOODEN TOP SHELF - PAINTED/VENEER

Painted and veneered shelves are FSC-certified.

WT5 - round single-sided wooden top shelf - standard depth - inner

Particleboard. Incl. fittings (snapfix and screws).	Degree	Shelf depth mm	Item no.	Painted	Veneer
	26	300	BN276561.	-	-
	18	300	BN276581.	-	-

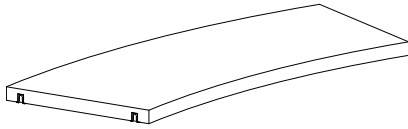

WT5 - round single-sided wooden top shelf - standard depth - outer

Particleboard. Incl. fittings (snapfix and screws).	Degree	Shelf depth mm	Item no.	Painted	Veneer
	26	300	BN276562.	-	-
	18	300	BN276582.	-	-

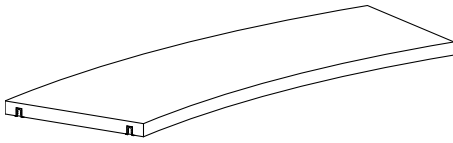

WT5 - round double-sided wooden top shelf

Particleboard. Incl. fittings (snapfix and screws).	Degree	Shelf depth mm	Item no.	Painted	Veneer
	26	300	BN276660.	-	-
	18	300	BN276680.	-	-

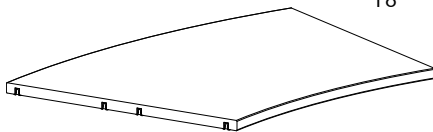

SHELVES

WT7 - ROUND WOODEN TOP SHELF - MELAMINE

WT7 - round single-sided wooden top shelf - standard depth - inner

Particleboard. Incl. fittings (snapfix and screws).	Degree	Shelf depth mm	Item no.	Melamine
	26	300	BN277561.	-
	18	300	BN277581.	-

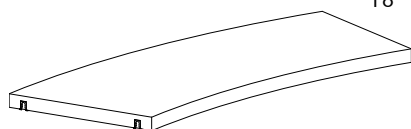

WT7 - round single-sided wooden top shelf - standard depth outer

Particleboard. Incl. fittings (snapfix and screws).	Degree	Shelf depth mm	Item no.	Melamine
	26	300	BN277562.	-
	18	300	BN277582.	-

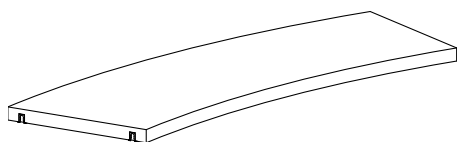

WT7 - round double-sided wooden top shelf

Particleboard. Incl. fittings (snapfix and screws).	Degree	Shelf depth mm	Item no.	Melamine
	26	300	BN277660.	-
	18	300	BN277680.	-

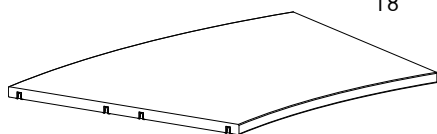

SHELVES

WO5 - ROUND WOODEN OVERLAYING TOP PLATE

Choose between a wooden top shelf (placed in between the wooden panels) or a wooden overlaying top plate (placed on top of the panels).

WO5 - ROUND WOODEN OVERLAYING TOP PLATE

Details:

- Melamine/painted/veneer
- Freestanding/outer/intermediate
- Max. weight 25 kg.
- Particle board

Use with:

- S5 - round steel shelves
- W5/W6/W7/W8 - round wooden shelves
- WP3/WP7 - wooden panel
- SBP5/7 - round steel back panel

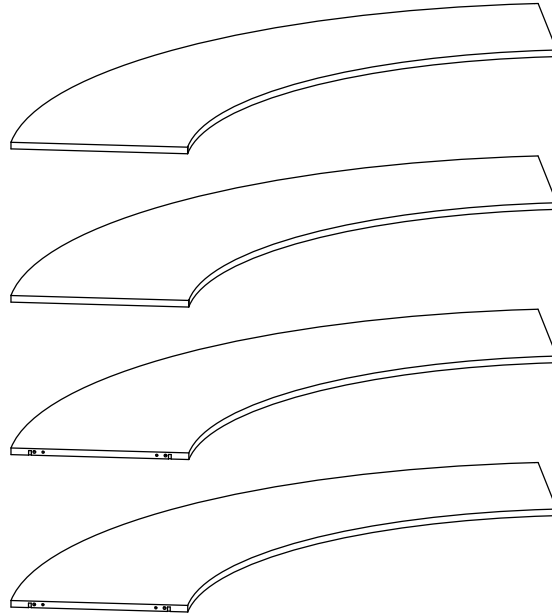

SHELVES

WO5 - ROUND WOODEN OVERLAYING TOP PLATE - DOUBLE-SIDED

Painted and veneered shelves are FSC-certified.

WO5 - round double-sided wooden overlaying top plate - freestanding

Particleboard. Incl. fittings.	Degree	Shelf depth mm	No. of bays	Item no.	Melamine	Painted	Veneer
	26	300	1	BN2306615.	-	-	-
	26	300	2	BN2306625.	-	-	-
	26	300	3	BN2306635.	-	-	-
	18	300	1	BN2306815.	-	-	-
	18	300	2	BN2306825.	-	-	-
	18	300	3	BN2306835.	-	-	-

WO5 - round double-sided wooden overlaying top plate - left outer

Particleboard. Incl. fittings.	Degree	Shelf depth mm	No. of bays	Item no.	Melamine	Painted	Veneer
	26	300	1	BN2306611.	-	-	-
	26	300	2	BN2306621.	-	-	-
	26	300	3	BN2306631.	-	-	-
	18	300	1	BN2306811.	-	-	-
	18	300	2	BN2306821.	-	-	-
	18	300	3	BN2306831.	-	-	-

WO5 - round double-sided wooden overlaying top plate - intermediate

Particleboard. Incl. fittings.	Degree	Shelf depth mm	No. of bays	Item no.	Melamine	Painted	Veneer
	26	300	1	BN2306613.	-	-	-
	26	300	2	BN2306623.	-	-	-
	26	300	3	BN2306633.	-	-	-
	18	300	1	BN2306813.	-	-	-
	18	300	2	BN2306823.	-	-	-
	18	300	3	BN2306833.	-	-	-

WO5 - round double-sided wooden overlaying top plate - right outer

Particleboard. Incl. fittings.	Degree	Shelf depth mm	No. of bays	Item no.	Melamine	Painted	Veneer
	26	300	1	BN2306612.	-	-	-
	26	300	2	BN2306622.	-	-	-
	26	300	3	BN2306632.	-	-	-
	18	300	1	BN2306812.	-	-	-
	18	300	2	BN2306822.	-	-	-
	18	300	3	BN2306832.	-	-	-

CASTORS

ROUND CASTOR FRAME & CASTOR PLATE



CASTORS

ROUND CASTOR FRAME & CASTORS

We recommend having a maximum of 3 adjoining bays mounted on castors.

Round castor frame set with visible castors

A set of 2 frames and 4 Ø75 mm castors. To be used with double-sided panels WP1, WP2, WP3, WP4 and back panels WPB1/WBP2. Max. height 1520 mm.

Degree	x castors with brake
26	0
26	2
18	0
18	2

Item no.
BN26060
BN26061
BN26080
BN26081

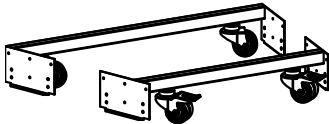

Castors for visible round castor frame set

Spare part. H112 mm, Ø75 mm. Max 90 kg. per castor.

Type

Item no.

Without brake

B7860100

With brake

B7860101

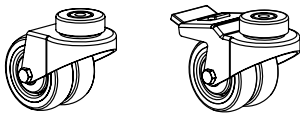

Round castor frame set with hidden castors and steel plinth

A set of 2 frames, 4 x Ø35 mm castors without brakes and 2 steel plinths. To be used with double-sided panels WP1, WP2, WP3, WP4 and back panels WPB1/WBP2. Max. height 1520 mm.

Degree

Item no.

26

BN2616

18

BN2618

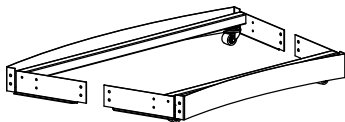

Castors for hidden round castor frame set

H50 mm, Ø35 mm. Spare part. Max. 100 kg per castor.

Type

Item no.

Without brake

B301017

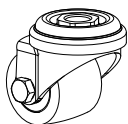

CASTORS

ROUND CASTOR PLATES

Painted and veneered castor plates are FSC-certified.

Double-sided round wooden castor plate

With 4/6/8 Ø75 mm castors, 2 of which are with brakes. To be used with double-sided panels WP5/WP7 for castor plate along with steel back panel SPB7/8 or steel back frame. Max. height 1520 mm.

Degree	Depth mm	No of bays	Item no.	Melamine	Painted	Veneer
26	300	1	BN250661.	-	-	-
26	300	2	BN250662.	-	-	-
26	300	3	BN250663.	-	-	-
18	300	1	BN250681.	-	-	-
18	300	2	BN250682.	-	-	-
18	300	3	BN250683.	-	-	-



Castors for round castor plate

Spare part. H102 mm, Ø75 mm. Max 100 kg. per castor.

Type	Item no.
Without brake	B400001025
With brake	B400001125

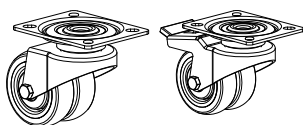

PLINTHS

ROUND STEEL PLINTHS

Painted and veneered plinths are FSC-certified.

Round steel plinth

Incl. screws. H71 mm. Cannot be used with castors.



26 Inner
26 Outer

Item no.
BN22761
BN22762

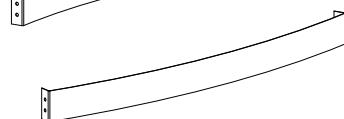

18 Inner
18 Outer

Item no.
BN22781
BN22782

WOODEN PANELS

DOUBLE-SIDED - WITH ADJUSTABLE FEET - FOR WOODEN TOP SHELF

Painted and veneered panels are FSC-certified.

WP1 - double-sided outer end panel with adjustable feet - for WT5

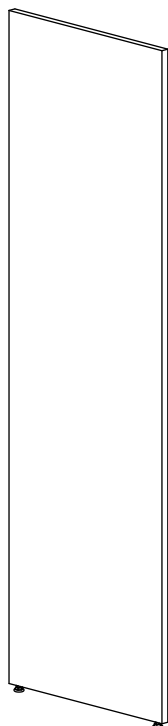

Height mm	Shelf depth mm	Item no.	Melamine	Painted	Veneer
720	300	BN0014265.	-	-	-
920	300	BN0014365.	-	-	-
1220	300	BN0014465.	-	-	-
1520	300	BN0014565.	-	-	-
1820	300	BN0014665.	-	-	-
2120	300	BN0014765.	-	-	-

WP1 - double-sided intermediate panel with adjustable feet - for WT5

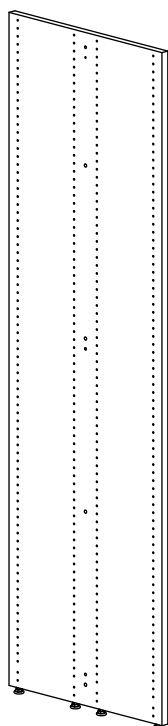

Height mm	Shelf depth mm	Item no.	Melamine	Painted	Veneer
720	300	BN0014264.	-	-	-
920	300	BN0014364.	-	-	-
1220	300	BN0014464.	-	-	-
1520	300	BN0014564.	-	-	-
1820	300	BN0014664.	-	-	-
2120	300	BN0014764.	-	-	-

WOODEN PANELS

DOUBLE-SIDED - WITH ADJUSTABLE FEET - FOR STEEL AND WOODEN TOP SHELF

Painted and veneered panels are FSC-certified.

WP2 - double-sided slat outer end panel with milled slat - with adjustable feet - for ST1/ST2/ST3 and WT1

H1520 has 2 slats, H1820 and 2120 has 3 slats.

Height
mm

Shelf depth
mm

Item no.

Melamine

Painted

Veneer

1520

300

BN0455651.

-

-

-

1820

300

BN0456651.

-

-

-

2120

300

BN0457651.

-

-

-

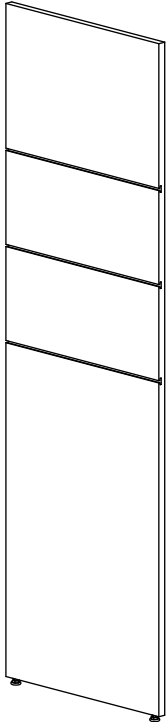

WOODEN PANELS

DOUBLE-SIDED - WITH ADJUSTABLE FEET & OVERLAYING TOP PLATE

Painted and veneered panels are FSC-certified.

WP3 - double-sided outer end panel with adjustable feet - for WO5

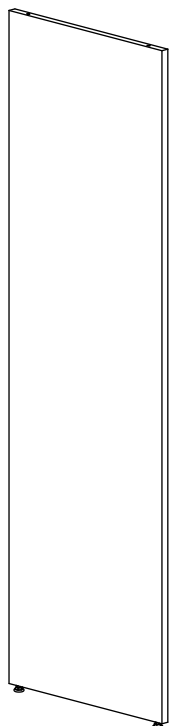

Height mm	Shelf depth mm	Item no.	Melamine	Painted	Veneer
720	300	BN0014269.	-	-	-
920	300	BN0014369.	-	-	-
1220	300	BN0014469.	-	-	-
1520	300	BN0014569.	-	-	-
1820	300	BN0014669.	-	-	-
2120	300	BN0014769.	-	-	-

WP3 - double-sided intermediate panel with adjustable feet - for WO5

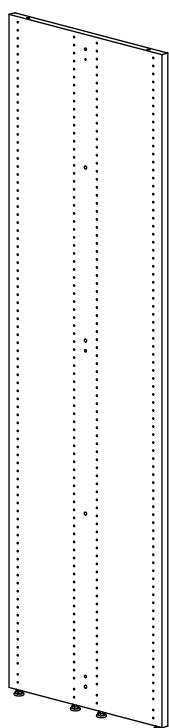

Height mm	Shelf depth mm	Item no.	Melamine	Painted	Veneer
720	300	BN0014268.	-	-	-
920	300	BN0014368.	-	-	-
1220	300	BN0014468.	-	-	-
1520	300	BN0014568.	-	-	-
1820	300	BN0014668.	-	-	-
2120	300	BN0014768.	-	-	-

WOODEN PANELS

DOUBLE-SIDED - WITH ADJUSTABLE FEET & OVERLAYING TOP PLATE

Painted and veneered panels are FSC-certified.

WP4 - double-sided slat outer end panel with milled slat and adjustable feet - for WO1

H1520 has 2 slats, H1820 and 2120 has 3 slats.

Height
mm

Shelf depth
mm

Item no.

Melamine

Painted

Veneer

1520

300

BN0455691.

-

-

-

1820

300

BN0456691.

-

-

-

2120

300

BN0457691.

-

-

-

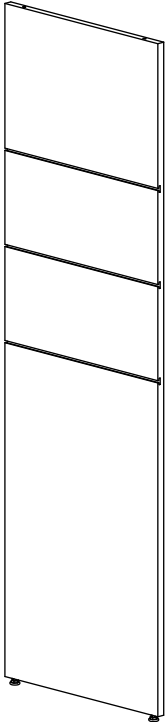

WOODEN PANELS

DOUBLE-SIDED - FOR CASTOR PLATE & WOODEN TOP SHELF

Painted and veneered panels are FSC-certified.

WP5 - double-sided outer end panel for castor plate - for WT5

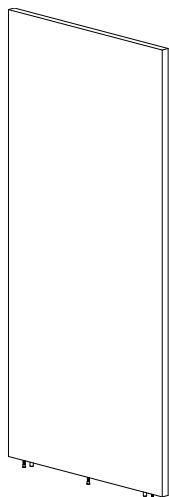

Height mm	Shelf depth mm	Item no.	Melamine	Painted	Veneer
720	300	BN0015265.	-	-	-
920	300	BN0015365.	-	-	-
1220	300	BN0015465.	-	-	-
1520	300	BN0015565.	-	-	-

WP5 - double-sided intermediate panel for castor plate - for WT5

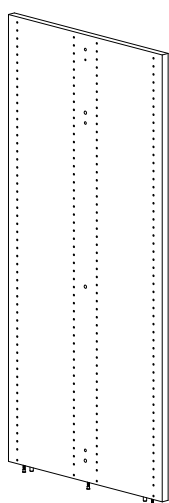

Height mm	Shelf depth mm	Item no.	Melamine	Painted	Veneer
720	300	BN0015264.	-	-	-
920	300	BN0015364.	-	-	-
1220	300	BN0015464.	-	-	-
1520	300	BN0015564.	-	-	-

WOODEN PANELS

DOUBLE-SIDED - FOR CASTOR PLATE & TOP SHELF

Painted and veneered panels are FSC-certified.

WP6 - double-sided slat outer end panel with milled slats - for castor plate - for ST1/ST2/ST3 and WT1

H1520 has 2 slats.

Height
mm

Shelf depth
mm

Item no.

Melamine

Painted

Veneer

1520

300

BN0465651.

-

-

-

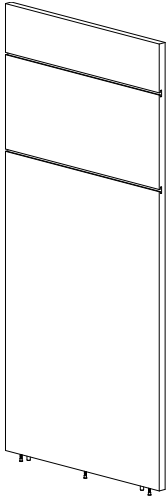

WOODEN PANELS

DOUBLE-SIDED - FOR CASTOR PLATE & OVERLAYING TOP PLATE

Painted and veneered panels are FSC-certified.

WP7 - double-sided outer end panel for castor plate - for WO5

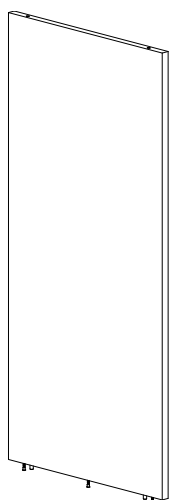

Height mm	Shelf depth mm	Item no.	Melamine	Painted	Veneer
720	300	BN0015269.	-	-	-
920	300	BN0015369.	-	-	-
1220	300	BN0015469.	-	-	-
1520	300	BN0015569.	-	-	-

WP7 - double-sided intermediate panel for castor plate - for WO5

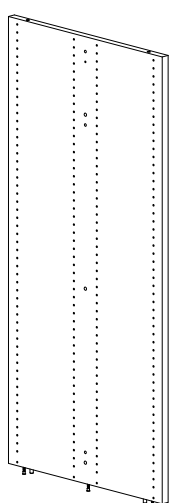

Height mm	Shelf depth mm	Item no.	Melamine	Painted	Veneer
720	300	BN0015268.	-	-	-
920	300	BN0015368.	-	-	-
1220	300	BN0015468.	-	-	-
1520	300	BN0015568.	-	-	-

WOODEN PANELS

DOUBLE-SIDED - FOR CASTOR PLATE & OVERLAYING TOP PLATE

Painted and veneered panels are FSC-certified.

WP8 - double-sided slat outer end panel with milled slat - for castor plate - for WO1

H1520 has 2 slats.

Height
mm

Shelf depth
mm

Item no.

Melamine

Painted

1520

300

BN0465691.

-

-

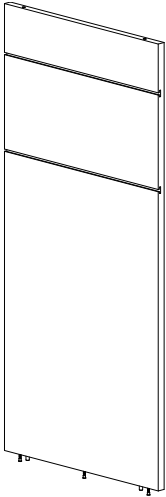

WOODEN PANELS

WOODEN END PANEL BAYS

Use the panel to create a display area on Lingo shelving system. The end panel bay is easily retrofitted on existing double-sided shelving systems with adjustable feet/castor frame (replace existing end panel with end panel bay). Painted and veneered panels are FSC-certified.

Wooden end panel bay - for bays with top shelf

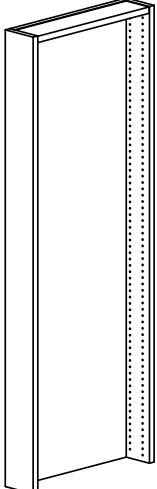
Fastening material included.	Height mm	Shelf depth mm	Width mm	Item no.	Melamine	Painted	Veneer
	720	300	598	BN5402B1.	-	-	-
	920	300	598	BN5403B1.	-	-	-
	1220	300	598	BN5404B1.	-	-	-
	1520	300	598	BN5405B1.	-	-	-
	1820	300	598	BN5406B1.	-	-	-
	2120	300	598	BN5407B1.	-	-	-

Wooden end panel bay - for bays with overlaying top plate

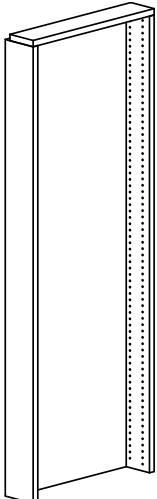
Fastening material included.	Height mm	Shelf depth mm	Width mm	Item no.	Melamine	Painted	Veneer
	720	300	598	BN5402B2.	-	-	-
	920	300	598	BN5403B2.	-	-	-
	1220	300	598	BN5404B2.	-	-	-
	1520	300	598	BN5405B2.	-	-	-
	1820	300	598	BN5406B2.	-	-	-
	2120	300	598	BN5407B2.	-	-	-

WOODEN PANELS

WOODEN END PANEL BAYS

The functions below are suited for hanging on wooden end panel bays. Painted and veneered products are FSC-certified.

Wooden sign for wooden end panel bay

H368 mm. Incl. fittings.	Width mm	Shelf depth mm	Item no.	Melamine	Painted	Veneer
	598	300	BN541B.	-	-	-

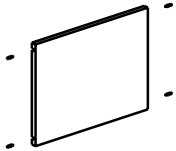

Steel display shelf for wooden end panel bay

H280 mm. Incl. fittings.	Width mm	Shelf depth mm	Item no.	Steel
	598	300	BN542B	-

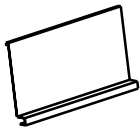

Wooden brochure rack for wooden end panel bay

H140 mm. Front and three adjustable dividers in acrylic glass. Incl. fittings.	Width mm	Shelf depth mm	Item no.	Melamine	Painted	Veneer
	598	300	BN543B.	-	-	-

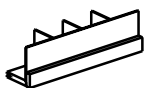

CONNECTION ELEMENTS

ROUND STEEL BACK PANELS - FOR ADJUSTABLE FEET

SBP5 - high steel back panel - for WT5/WT7 (standard depth)/WO5

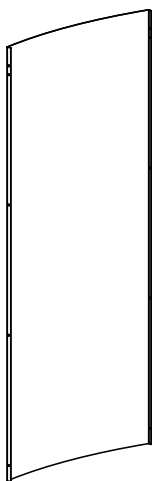

Degree	Height mm	Item no.
26	720	BN219264
26	920	BN219364
26	1220	BN219464
26	1520	BN219564
26	1820	BN219664
26	2120	BN219764
18	720	BN219284
18	920	BN219384
18	1220	BN219484
18	1520	BN219584
18	1820	BN219684
18	2120	BN219784

SBP6 - low steel back panel - for WT5/WT7 (double-sided)

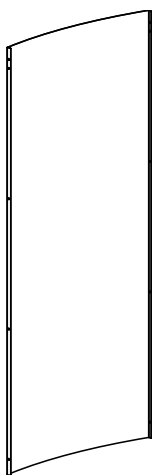

Degree	Height mm	Item no.
26	720	BN219266
26	920	BN219366
26	1220	BN219466
26	1520	BN219566
26	1820	BN219666
26	2120	BN219766
18	720	BN219286
18	920	BN219386
18	1220	BN219486
18	1520	BN219586
18	1820	BN219686
18	2120	BN219786

CONNECTION ELEMENTS

ROUND STEEL BACK PANELS - FOR CASTOR PLATE

SBP7 - high steel back panel - for WT5/WT7 (standard depth)/WO5

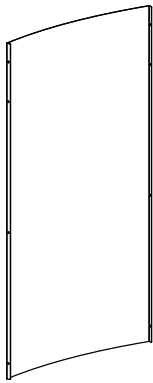

Degree	Height mm	Item no.
26	720	BN220264
26	920	BN220364
26	1220	BN220464
26	1520	BN220564
18	720	BN220284
18	920	BN220384
18	1220	BN220484
18	1520	BN220584

SBP8 - low steel back panel - for WT5/WT7 (double-sided)

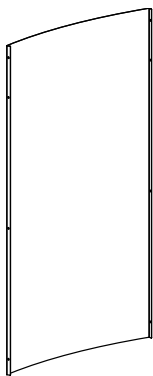

Degree	Height mm	Item no.
26	720	BN220266
26	920	BN220366
26	1220	BN220466
26	1520	BN220566
18	720	BN220286
18	920	BN220386
18	1220	BN220486
18	1520	BN220586

CONNECTION ELEMENTS

ROUND STEEL BACK FRAME

To ensure correct stability, double-sided shelvings H1820 mm and H2120 mm with back frame must have an additional steel back frames installed depending on number of bays. Configurations for freestanding bays include one additional back frame. Back frame for intermediate bays must be ordered separately, see overview page 11.

Round steel back frame

With fittings.

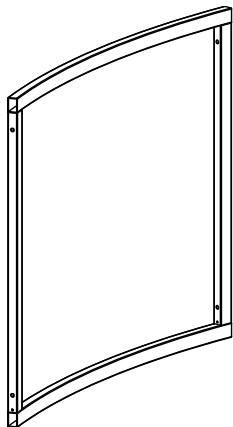

Degree	Bay	Item no.
26	Freestanding	BN21064ZZZ8
26	Intermediate	BN21064ZZZ9
18	Freestanding	BN21084ZZZ8
18	Intermediate	BN21084ZZZ9





DANEMARK

Lammhults Biblioteksdesign A/S
Dalbækvej 1
6670 Holsted

bci@bci.dk
www.bci.dk

SCHWEDEN

Lammhults Biblioteksdesign AB
Odlarevägen 16
226 60 Lund

eurobib@eurobib.se
www.eurobib.se

GROSSBRITANNIEN

thedesignconcept Ltd.
The Old Bakery,
10 Greenless Road
Cambuslang Belgrave Street
Glasgow G72 8JJ

info@thedesignconcept.co.uk
www.thedesignconcept.co.uk

FRANKREICH

BC Intérieur Sarl
6 allée Kepler
77420 Champs sur Marne

bci@bcinterieur.com
www.bcinterieur.com

DEUTSCHLAND

Schulz Speyer Bibliothekstechnik AG
Hafenstraße 2
67346 Speyer

sales@schulzspeyer.de
www.schulzspeyer.de

NORWEGEN

BS Eurobib AS
Alf Bjerckes Vei 20
0582 Oslo

post@bseurobib.no
www.bseurobib.no

BELGIEN

SBNL - Schulz Benelux BVBA
Appelweg 94 C
3221 Holsbeek

info@sbnl.be
www.sbnl.be